

MAIN
CATALOGUE
22 // 23

EXPERTISE IN LIGHT

our sales team for office and field service



DISTRIBUTION NATIONAL

+49 7248 9271 500
deko@deko-light.com

DISTRIBUTION INTERNATIONAL

+49 7248 9271 600
exporteu@deko-light.com

All prices are recommended gross sales prices including VAT. We keep the right to adjust the prices during the validity of the catalogue. You will always find the current prices on our website. Our general terms and conditions apply. Errors and availability reserved. All articles are basically delivered without illuminants, unless the product description specifies otherwise.

5 YEAR MANUFACTURER'S WARRANTY

All DEKO-LIGHT brand products come with a five-year extended warranty.

DEKO-LIGHT lighting solutions have always stood for maximum reliability and performance based on strict quality guidelines. For example, the products are regularly checked during the development and production process in order to provide users from all sectors with a fault-free product. The extension of the manufacturer's warranty underlines this quality promise once again.



INTERIOR LIGHTS

- 04 pendant lights
- 48 surface mounted ceiling lights
- 90 built in ceiling lights
- 152 insert panels
- 154 insert panels | backlight technology
- 160 insert panels | sidelight technology
- 170 surface mounted wall lights
- 200 built in wall lights
- 204 reading lights
- 210 table and floor lights
- 224 furniture lights
- 238 showcase lights
- 246 office lights
- 268 hall floodlight
- 274 damp-proof luminaires
- 282 emergency lights

POWER RAILS

- 290 D LINE power rail system
- 318 power luminaires

BATTERY AND SOLAR LIGHTS

- 342 battery lights
- 354 solar lights

OUTDOOR LIGHTS

- 362 bollard lights
- 386 surface mounted wall lights
- 424 ceiling and wall lights
- 430 built in wall lights
- 440 spherical and floor lamps
- 446 energy distributor
- 454 surface mounted and ground spike lights
- 468 wall washer
- 472 ground recessed lights
- 502 underwater lights
- 508 floodlight
- 516 display lights

ALUMINIUM PROFILES

- 532 U-profiles | flat + high | built-in/built-on
- 544 T-profiles | flat + high | built-in
- 556 H- und groove-profiles
- 566 step/plinth/angle/corner-profiles | built-in/built-on
- 592 dry construction profiles
- 602 tile profiles
- 618 profiles for outdoor use | walkable/trafficable

LED STRIPES

- 634 quick finder
- 638 COB | 1CH / 2CH / 3CH | 24V
- 646 standard | 1CH | 12V / 24V / 48V
- 656 standard | 2CH | 12V / 24V
- 662 standard | 3CH | 24V
- 666 standard | 4CH | 24V
- 670 D FLEX LINE top-view | 1CH / 3CH / 4CH | 24V
- 678 D FLEX LINE side-view | 1CH / 4CH | 24V
- 684 230V | 1CH

POWER SUPPLIES

- 692 DC | CV | quick finder
- 696 DC | CV
- 708 DC | CC | quick finder
- 710 DC | CC
- 722 DC | CC/CV
- 724 AC | CV | quick finder
- 725 AC | CV
- 727 gear units for metal vapour lamps

CONTROLLER

- 732 Quasar
- 740 Casambi Bluetooth
- 742 RF controller | 1 - 4 channel
- 744 RF touchpanel | 1 - 4 channel
- 746 quick finder | DMX controller
- 747 quick finder | DMX dimmer
- 748 DMX wall controller
- 752 DMX controller
- 754 DMX dimmer
- 758 DALI PWM dimmer

ILLUMINANTS

- 764 G4
- 764 AR111
- 765 MR16/GU5,3
- 766 G9
- 767 GU10
- 768 GU10/ES111
- 769 E14
- 770 E27
- 774 R7s
- 774 GX53
- 775 neon tubes
- 776 metal vapour lamps

ACCESSORIES

- 782 indoor | dimming
- 785 indoor | other
- 787 indoor | low voltage
- 791 outdoor | low voltage DC | WEIPU HQ plug-in connector
- 794 DMX cable
- 796 indoor | high voltage
- 799 outdoor | high voltage | plug systems
- 801 outdoor | cable connectors
- 804 mounting material for LED stripes and profiles
- 805 outdoor | mounting accessories
- 806 chemical products



INTERIOR LIGHTS

- 04 pendant lights
- 48 surface mounted ceiling lights
- 90 built in ceiling lights
- 152 insert panels
- 154 insert panels | backlight technology
- 160 insert panels | sidelight technology
- 170 surface mounted wall lights
- 200 built in wall lights
- 204 reading lights
- 210 table and floor lights
- 224 furniture lights
- 238 showcase lights
- 246 office lights
- 268 hall floodlight
- 274 damp-proof luminaires
- 282 emergency lights



□ □ □
■ ■ ■
page 09



□ □ □



□ □



□ □ □



□ □



□ □



□ □



■



■



□



■



■ ■



■ ■



□ □



□ □



□ □



□ □



□ □



□ □



□



□



□



□

pendant lights



□
page 30



□ □ □
page 32



□ □ □
page 34



□ □ □
page 34



□ □
page 36



□ □ □
□ □
page 39



□ □ □
□ □
page 41



□ □ □
page 43



□ □ □
page 45



□
page 46

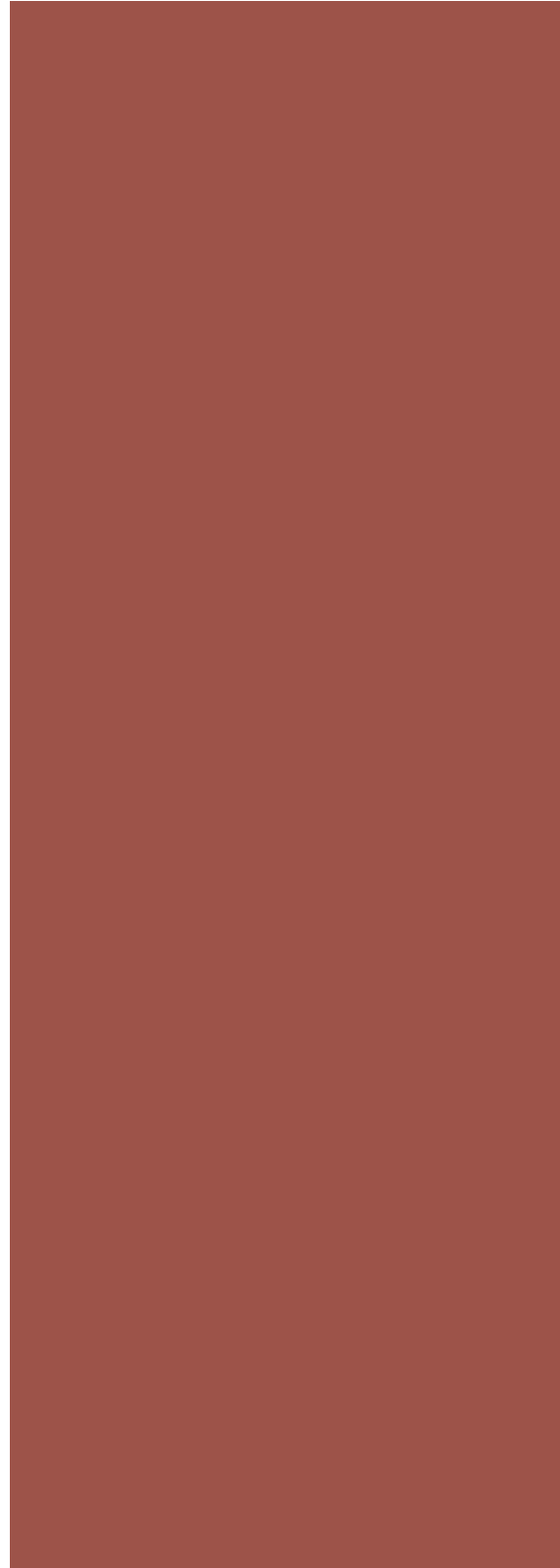



DIVERSITY

As colourful as life itself - with DIVERSITY we set an example for more colour and diversity. The pendant luminaire series based on a patented design by Johannes Tomm offers a choice of seven colours and can be combined as desired. With a cable length of 3 metres, DIVERSITY is also convincing in high rooms. The retrofit compatibility with all E27 light sources of the A60 design allows even more variety.



DIVERSITY

- Design by Johannes Tomm
- wide range of colours
- dimensions L x Ø: 200 x 280 mm
- socket H x Ø: 25 x 100 mm
- max. suspension: 3000 mm
- dimmable via optional illuminants

item	colour	price
342170	 white	79,95 €
342172	 grey	79,95 €
342171	 black	79,95 €
342173	 red	79,95 €
342174	 yellow	79,95 €
342175	 blue	79,95 €
342176	 green	79,95 €



suitable illuminants on page 770-773



ASTEROPE

Light & shadow: Hardly any luminaire embodies this dualism more beautifully than the ASTEROPE in its various versions. The downward-opening pendant luminaire creates a multifaceted play of light and shadow on walls and ceilings that blends extravagantly yet harmoniously into any ambience. Our tip: Combine the ASTEROPE with a goldcoloured or milky light source from the Filament series.

ASTEROPE ROUND

- metal
- socket H x Ø: 25 x 120 mm
- max. suspension: 1095 mm
- dimmable via optional illuminants

item	colour	dimensions L x Ø	power	price
342129	□ white	1400 x 250 mm	1x max. 40 W	94,95 €
342132	■ black	1400 x 250 mm	1x max. 40 W	94,95 €
342130	□ white	1500 x 400 mm	1x max. 40 W	189,95 €
342133	■ black	1500 x 400 mm	1x max. 40 W	189,95 €
342131	□ white	1600 x 500 mm	3x max. 40 W	279,95 €
342134	■ black	1600 x 500 mm	3x max. 40 W	279,95 €



suitable illuminants on page 770-771

ASTEROPE LINEAR

- metal
- dimensions L x H x Ø: 1500 x 300 x 150 mm
- socket H x Ø: 25 x 120 mm
- max. suspension: 1175 mm
- dimmable via optional illuminants

item	colour	price
342135	□ white	94,95 €
342136	■ black	94,95 €



suitable illuminants on page 770-771, 773



suitable
wall lights
page 172
341216
341217



suitable
table /
floor lights
page 216
346003
346004
343020
343021



LUCEA 10

- aluminium diecast
- dimensions H x Ø: 157 x 65 mm
- socket H x Ø: 29 x 104,5 mm
- max. suspension: 1800 mm
- dimmable via phase control or phase cut-off
- light colour adjustable via dip switch

item	colour	colour temperature	light current	price
342177	white	3000 / 4000 K	930 / 1000 lm	139,95 €
342178	black	3000 / 4000 K	930 / 1000 lm	139,95 €



accessories

930679 lens 24° **9,95 €**



suitable surface mounted ceiling lights from page 84
348153
348154
348161
348162



suitable power luminaires from page 332
707116
707117
707124
707125

LUCEA 15 + 20

- aluminium diecast
- dimensions H x Ø: 178 x 85 mm
- socket H x Ø: 29 x 104,5 mm
- max. suspension: 1800 mm
- dimmable via phase control or phase cut-off
- light colour adjustable via dip switch

item	colour	colour temperature	light current	power	price
342179	white	3000 / 4000 K	1460 / 1500 lm	15 W	159,95 €
342180	black	3000 / 4000 K	1460 / 1500 lm	15 W	159,95 €
342181	white	3000 / 4000 K	1930 / 2000 lm	20 W	179,95 €
342182	black	3000 / 4000 K	1930 / 2000 lm	20 W	179,95 €

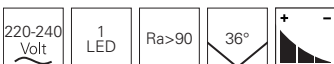

accessories

930680 lens 24° **12,95 €**

930681 lens 60° **12,95 €**



suitable surface mounted ceiling lights from page 84
348155-348158
348163-348166



suitable power luminaires from page 332
707118-707121
707126-707129





SLIM

- aluminium diecast
- dimensions H x Ø: 300 x 39 mm
- socket H x Ø: 25 x 100 mm
- max. suspension: 1800 mm
- textile cable
- UGR <19

item	colour	colour temperature	light current	price
342214	□ white	ww 3000 K	500 lm	79,95 €
342213	■ black	ww 3000 K	500 lm	79,95 €

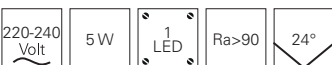

suitable
power
luminaires
page 335
707133
707132

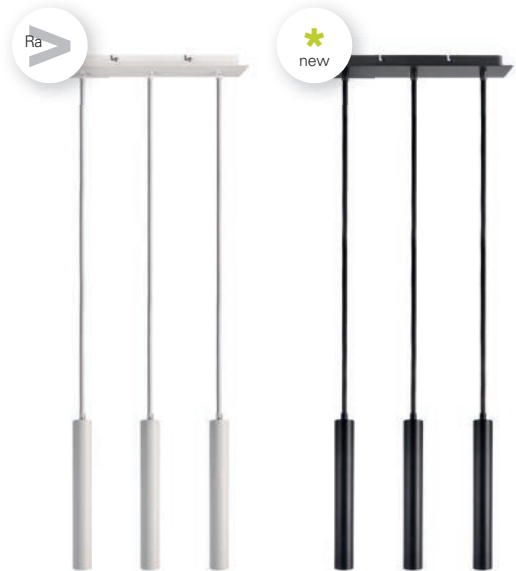

SLIM

- aluminium diecast
- dimensions H x Ø: 300 x 39 mm
- socket L x B x H: 370 x 80 x 26 mm
- max. suspension: 1800 mm
- textile cable
- UGR <19

item	colour	colour temperature	light current	price
342216	□ white	www 3000 K	3x 500 lm	209,95 €
342215	■ black	www 3000 K	3x 500 lm	209,95 €

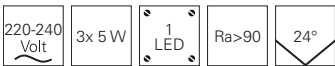

SLIM

- aluminium diecast
- dimensions H x Ø: 300 x 39 mm
- socket H x Ø: 240 x 25 mm
- max. suspension: 1800 mm
- textile cable
- UGR <19

item	colour	colour temperature	light current	price
342218	□ white	www 3000 K	3x 500 lm	209,95 €
342217	■ black	www 3000 K	3x 500 lm	209,95 €

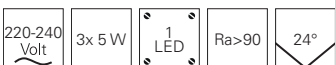

POLARIS

- concrete
- dimensions L x B x H: 70 x 70 x 250 mm
- socket L x B x H: 80 x 80 x 30 mm
- max. suspension: 1200 mm
- dimmable via optional illuminants

item	colour	price
342095	 grey	69,95 €



suitable illuminants on page 767-768



POLLUX

- concrete
- dimensions H x Ø: 250 x 70 mm
- socket H x Ø: 35 x 90 mm
- max. suspension: 1200 mm
- dimmable via optional illuminants

item	colour	price
342096	 grey	69,95 €



suitable illuminants on page 767-768





BARRO II

- gypsum
- dimensions H x Ø: 250 x 70 mm
- socket H x Ø: 31 x 70 mm
- max. suspension: 1200 mm
- dimmable via optional illuminants

item	colour	price
342024	<input type="checkbox"/> white paintable	75,95 €



suitable illuminants on page 767-768



CONCRETO I

- concrete
- dimensions H x Ø: 188 x 188 mm
- socket H x Ø: 25 x 120 mm
- max. suspension: 1600 mm
- dimmable via optional illuminants

item	colour	price
342128	<input checked="" type="checkbox"/> grey	75,95 €



suitable illuminants on page 770-771

PAVONIS & CYGNI

concrete – a timeless companion. In the meantime, the functional and visual advantages of this ubiquitous material have also reached the lighting industry. Due to the stability of concrete, even large luminaires can be built narrowly. Our PAVONIS & CYGNI models combine the timelessly modern concrete look with elegant brass or chrome surfaces.

For this photo, the light sources 180239 for the PAVONIS and 180062 for the CYGNI were used.

PAVONIS

- concrete
- dimensions H x Ø: 199 x 140 mm
- socket H x Ø: 25 x 120 mm
- max. suspension: 1500 mm
- dimmable via optional illuminants

item	colour	price
342103	grey	65,95 €
342104	dark grey	65,95 €



suitable illuminants on page 770-773



CYGNI

- concrete
- dimensions H x Ø: 285 x 400 mm
- socket H x Ø: 25 x 120 mm
- max. suspension: 1500 mm
- dimmable via optional illuminants

item	colour	price
342101	grey	119,95 €
342102	dark grey	119,95 €



suitable illuminants on page 770-773





BASKET

The BASKET Series comprises two decorative pendant lights in different sizes. The name says it: The gracefully built lampshade imitates a basketwork and is fully made of gypsum. Like the color of gypsum, the shade is white coloured and creates a warm and natural light impression.



BASKET

- gypsum
- socket H x Ø: 25 x 100 mm
- max. suspension: 3000 mm
- dimmable via optional illuminants

item	colour	dimensions L x Ø	price
342142	<input type="checkbox"/> white	101 x 206 mm	81,95 €
342143	<input type="checkbox"/> white	168 x 344 mm	145,95 €



suitable illuminants on page 770-773



TWISTER

Elegant design with innovative details meets exceptional choice of materials: The TWISTER series combines decorative floor, table and pendant luminaires in different sizes, made entirely of plaster. We turn the cable into a design element! Entirely in classic white, the luminaires are only interrupted by a red cable. This makes the TWISTER series an eye-catcher not only in living areas, but also in hotels or restaurants.

TWISTER I

- Design by Johannes Tomm
- red textile cable
- gypsum
- easy cleaning through surface treatment
- dimensions H x Ø: 185 x 180 mm
- socket H x Ø: 25 x 120 mm
- max. suspension: 3000 mm
- dimmable via optional illuminants

item	colour	price
342144	<input type="checkbox"/> white	119,95 €



suitable illuminants on page 769



suitable
table /
floor lights
page 218
346010
343017

TWISTER II

- Design by Johannes Tomm
- red textile cable
- gypsum
- easy cleaning through surface treatment
- dimensions H x Ø: 282 x 280 mm
- socket H x Ø: 25 x 120 mm
- max. suspension: 3000 mm
- dimmable via optional illuminants

item	colour	price
342145	<input type="checkbox"/> white	169,95 €



suitable illuminants on page 770-773



suitable
table /
floor lights
page 218
346010
343017





FILO BALL

- metal
- dimensions H x Ø: 160 x 160 mm
- socket H x Ø: 25 x 100 mm
- max. suspension: 1200 mm
- dimmable via optional illuminants

item	colour	price
342029	■ silver coloured	74,95 €
342030	■ black	74,95 €



suitable illuminants on page 766



FILO MOB

- metal
- dimensions H x Ø: 190 x 190 mm
- socket H x Ø: 25 x 100 mm
- max. suspension: 1200 mm
- dimmable via optional illuminants

item	colour	price
342025	■ silver coloured	77,95 €
342026	■ black	77,95 €



suitable illuminants on page 770-773



FILO BIG MOB

- metal
- dimensions H x Ø: 300 x 300 mm
- socket H x Ø: 25 x 100 mm
- max. suspension: 1200 mm
- dimmable via optional illuminants

item	colour	price
342027	 silver coloured	169,95 €
342028	 black	169,95 €



suitable illuminants on page 770-773



FILO SAT

- metal
- dimensions H x Ø: 180 x 390 mm
- socket H x Ø: 25 x 100 mm
- max. suspension: 1200 mm
- dimmable via optional illuminants

item	colour	price
342031	 silver coloured	179,95 €
342032	 black	179,95 €



suitable illuminants on page 770-773

ELECTRA

Could it be any cooler? Sure – ELECTRA! The combination of silver-coloured chrome lampshade and modern LED technology underlines modern interiors and serves as an elegant eye-catcher above tables and other furniture.

But don't worry: with its warm light colour, ELECTRA creates a cosy, warm atmosphere.



ELECTRA

- glass
- dimensions Ø: 115 mm
- socket H x Ø: 25 x 100 mm
- max. suspension: 1200 mm
- dimmable via phase control or phase cut-off

item	colour	colour temperature	light current	price
342116	 silver coloured chrome	 3000 K	180 lm	109,95 €



ELECTRA

- glass
- dimensions Ø: 115 mm
- socket L x B x H: 610 x 75 x 25 mm
- max. suspension: 1200 mm
- dimmable via phase control or phase cut-off

item	colour	colour temperature	light current	price
342117	 silver coloured chrome	 3000 K	540 lm	209,95 €







BUNDA

- glass
- dimensions Ø: 135 mm
- socket H x Ø: 25 x 100 mm
- max. suspension: 1200 mm
- dimmable via optional illuminants

item	colour	price
342114	 silver coloured chrome	64,95 €



suitable illuminants on page 766



BUNDA

- glass
- dimensions Ø: 135 mm
- socket L x B x H: 610 x 75 x 25 mm
- max. suspension: 1200 mm
- dimmable via optional illuminants

item	colour	price
342115	 silver coloured chrome	144,95 €



suitable illuminants on page 766



FURNEL

The world in a sphere - the FURNEL pendant luminaire fills your room with a pleasant light and reflects the surroundings via its mirrored glass surface. Room and luminaire can hardly be brought together in a more natural way.



in the off-state



in the on-state

FURNEL

- glass
- dimensions Ø: 350 mm
- socket H x Ø: 25 x 100 mm
- max. suspension: 1200 mm
- dimmable via optional illuminants

item	colour	price
342109	 silver coloured mirrored	149,95 €



suitable illuminants on page 770-773



DIPHDA





Bring the Orient into your home: Are you looking for the final eye-catcher to add the finishing touch to your dignified modern retro interior? With its copper-coloured surface, the DIPHDA sets cultivated light accents that cut an excellent figure in bars and lounges as well as in living areas.

The light sources 180205 for the small and 180060 for the large DIPHDA were used for this photo.



DIPHDA

- glass
- socket H x Ø: 25 x 100 mm
- max. suspension: 1200 mm
- dimmable via optional illuminants

item	colour	dimensions L x Ø	price
342118	 silver coloured chrome	1200 x 150 mm	59,95 €
342120	 copper coloured	1200 x 150 mm	59,95 €
342119	 silver coloured chrome	1200 x 200 mm	79,95 €
342121	 copper coloured	1200 x 200 mm	79,95 €



suitable illuminants on page 770-773

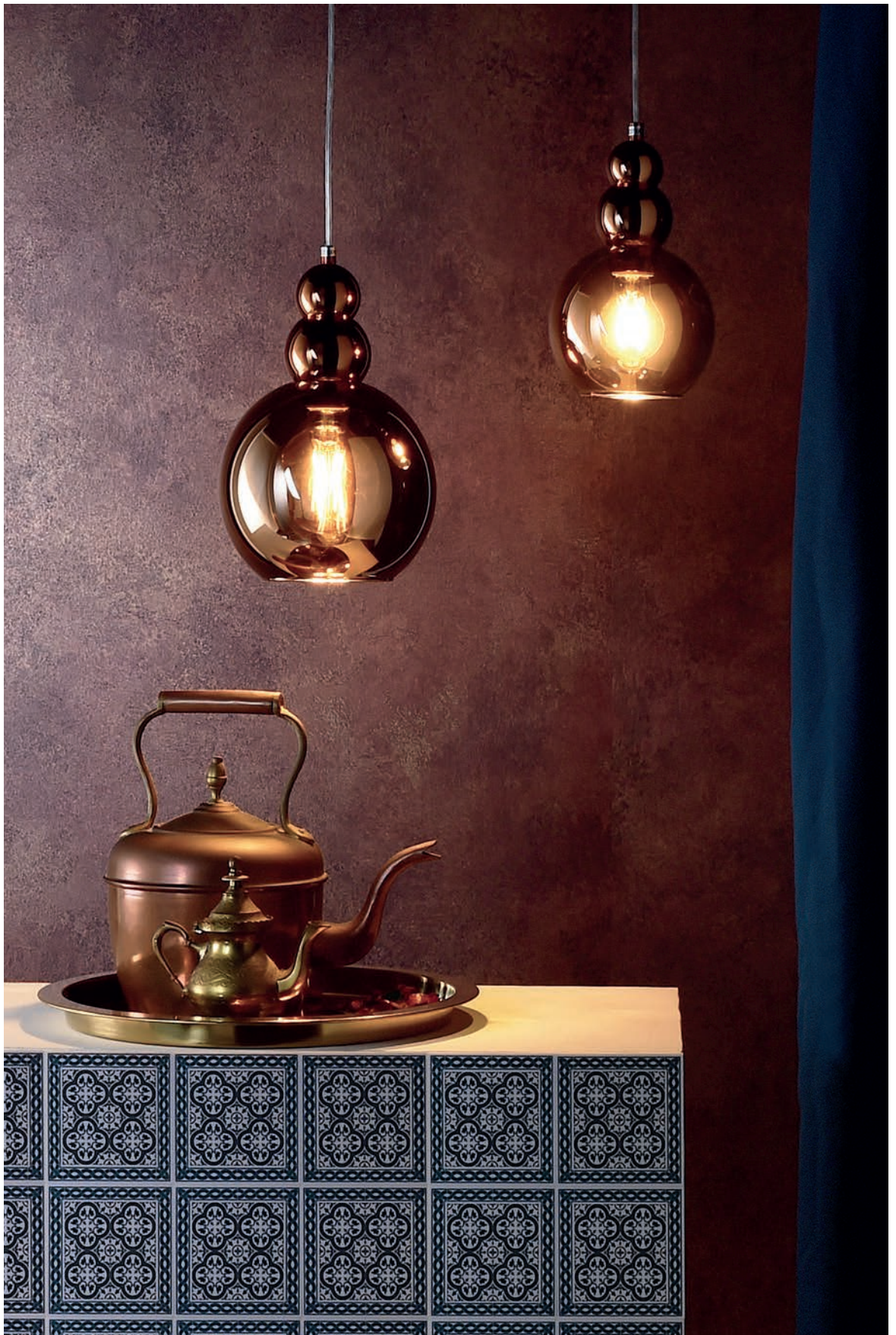



BARREL

Full focus: The BARREL pendant luminaire concentrates entirely on its most important task - illuminating a specific area. This is not least due to the noble metal shade, which ensures glare-free lighting pleasure throughout.

The illuminant 180071 was used for the picture on the right.

BARREL

- metal
- dimensions L x Ø: 250 x 100 mm
- socket H x Ø: 25 x 120 mm
- max. suspension: 1000 mm
- dimmable via optional illuminants

item	colour	price
342049	 copper coloured	69,45 €
342050	 silver coloured satined	69,45 €
342051	 black	69,45 €





suitable illuminants on page 770-773



BELL

- metal
- dimensions L x Ø: 300 x 300 mm
- socket H x Ø: 25 x 120 mm
- max. suspension: 1000 mm
- dimmable via optional illuminants

item	colour	price
342052	 copper coloured	119,95 €
342053	 silver coloured satined	119,95 €
342054	 black	119,95 €



suitable illuminants on page 770-773





ANKAA



Step closer, risk a look: The ANKAA pendant luminaire is dominated by timeless metal, which is interrupted by horizontal light slits and in this way not only creates an extraordinary room light, but will also catch the eye of your guests.

The light sources 180060 for the small and 180061 for the large ANKAA were used for this photo.



ANKAA

- metal
- socket H x Ø: 25 x 120 mm
- max. suspension: 1175/1195 mm
- dimmable via optional illuminants

item	colour	dimensions L x Ø	price
342137	 stainless steel brushed	1400 x 200 mm	89,95 €
342138	 stainless steel brushed	1500 x 280 mm	129,95 €



suitable illuminants on page 770-773







MENKAR 400 + 600

- timeless, minimalist design
- high light current [indirect light component ca. 15 - 20%]
- aluminium
- socket H x Ø: 30 x 100 mm
- max. suspension: 1800 mm
- light colour adjustable via dip switch
- dimmable via phase control or phase cut-off



suitable
ceiling lights
page 59
348198-348205

item	colour	colour temperature	light current	dimensions H x Ø	power	light source	price
342201	<input type="checkbox"/> white	WW NW 3000/4000 K	3100/3200 lm	60 x 400 mm	43 W	224 LED	239,95 €
342203	<input type="checkbox"/> silver brushed	WW NW 3000/4000 K	3100/3200 lm	60 x 400 mm	43 W	224 LED	239,95 €
342204	<input type="checkbox"/> coffee brushed	WW NW 3000/4000 K	3100/3200 lm	60 x 400 mm	43 W	224 LED	239,95 €
342202	<input type="checkbox"/> black	WW NW 3000/4000 K	3100/3200 lm	60 x 400 mm	43 W	224 LED	239,95 €
342205	<input type="checkbox"/> white	WW NW 3000/4000 K	5500/5600 lm	60 x 600 mm	65 W	400 LED	399,95 €
342207	<input type="checkbox"/> silver brushed	WW NW 3000/4000 K	5500/5600 lm	60 x 600 mm	65 W	400 LED	399,95 €
342208	<input type="checkbox"/> coffee brushed	WW NW 3000/4000 K	5500/5600 lm	60 x 600 mm	65 W	400 LED	399,95 €
342206	<input type="checkbox"/> black	WW NW 3000/4000 K	5500/5600 lm	60 x 600 mm	65 W	400 LED	399,95 €

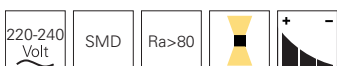

MENKAR 800

- timeless, minimalist design
- high light current [indirect light component ca. 15 - 20%]
- aluminium
- socket H x Ø: 30 x 100 mm
- max. suspension: 3000 mm
- light colour adjustable via dip switch
- dimmable via phase control or phase cut-off



suitable
ceiling lights
page 59
348206-348209

item	colour	colour temperature	light current	dimensions H x Ø	power	light source	price
342209	<input type="checkbox"/> white	WW NW 3000/4000 K	7600/7800 lm	60 x 800 mm	95 W	576 LED	559,95 €
342211	<input type="checkbox"/> silver brushed	WW NW 3000/4000 K	7600/7800 lm	60 x 800 mm	95 W	576 LED	559,95 €
342212	<input type="checkbox"/> coffee brushed	WW NW 3000/4000 K	7600/7800 lm	60 x 800 mm	95 W	576 LED	559,95 €
342210	<input type="checkbox"/> black	WW NW 3000/4000 K	7600/7800 lm	60 x 800 mm	95 W	576 LED	559,95 €

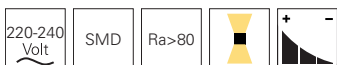



MEROPE

The pendant lights of the MEROPE Series unite timeless elegance and reduced modernity. Available diameters are 400, 600 and 800mm and the light colour [3000K/4000K] can be chosen with a switch before mounting. The outer ring is finished in white, silver, coffee brown or black.

* new from 2023



MEROPE 400 + 600

- timeless, minimalist design
- high light current
- aluminium
- socket H x Ø: 65 x 220 mm
- max. suspension: 1800 mm
- light colour adjustable via dip switch
- dimmable via phase control or phase cut-off



suitable
ceiling lights
page 61
348186-348193

item	colour	colour temperature	light current	dimensions H x Ø	power	light source	price
342189	<input type="checkbox"/> white	WW NW 3000/4000 K	2100/2200 lm	35 x 380 mm	30 W	144 LED	209,95 €
342191	<input type="checkbox"/> silver brushed	WW NW 3000/4000 K	2100/2200 lm	35 x 380 mm	30 W	144 LED	209,95 €
342192	<input type="checkbox"/> coffee brushed	WW NW 3000/4000 K	2100/2200 lm	35 x 380 mm	30 W	144 LED	209,95 €
342190	<input type="checkbox"/> black	WW NW 3000/4000 K	2100/2200 lm	35 x 380 mm	30 W	144 LED	209,95 €
342193	<input type="checkbox"/> white	WW NW 3000/4000 K	3100/3200 lm	35 x 580 mm	42 W	240 LED	279,95 €
342195	<input type="checkbox"/> silver brushed	WW NW 3000/4000 K	3100/3200 lm	35 x 580 mm	42 W	240 LED	279,95 €
342196	<input type="checkbox"/> coffee brushed	WW NW 3000/4000 K	3100/3200 lm	35 x 580 mm	42 W	240 LED	279,95 €
342194	<input type="checkbox"/> black	WW NW 3000/4000 K	3100/3200 lm	35 x 580 mm	42 W	240 LED	279,95 €

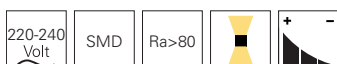

MEROPE 800

- timeless, minimalist design
- high light current
- aluminium
- socket H x Ø: 65 x 275 mm
- max. suspension: 3000 mm
- light colour adjustable via dip switch
- dimmable via phase control or phase cut-off



suitable
ceiling lights
page 61
348194-348197

item	colour	colour temperature	light current	dimensions H x Ø	power	light source	price
342197	<input type="checkbox"/> white	WW NW 3000/4000 K	4800/4900 lm	35 x 780 mm	60 W	384 LED	469,95 €
342199	<input type="checkbox"/> silver brushed	WW NW 3000/4000 K	4800/4900 lm	35 x 780 mm	60 W	384 LED	469,95 €
342200	<input type="checkbox"/> coffee brushed	WW NW 3000/4000 K	4800/4900 lm	35 x 780 mm	60 W	384 LED	469,95 €
342198	<input type="checkbox"/> black	WW NW 3000/4000 K	4800/4900 lm	35 x 780 mm	60 W	384 LED	469,95 €

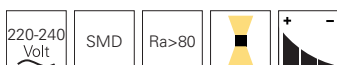





SCULPTORIS 400 + 600

- timeless, minimalist design
- high light current
- aluminium
- socket H x Ø: 65 x 220 mm
- max. suspension: 1800 mm
- light colour adjustable via dip switch
- dimmable via phase control or phase cut-off



suitable
ceiling lights
page 63
348180-348183

item	colour	colour temperature	light current	dimensions H x Ø	power	light source	price
342183	□ white	ww nw 3000/4000 K	1900/2000 lm	85 x 400 mm	30 W	168 LED	289,95 €
342184	■ black	ww nw 3000/4000 K	1900/2000 lm	85 x 400 mm	30 W	168 LED	289,95 €
342185	□ white	ww nw 3000/4000 K	3000/3100 lm	110 x 600 mm	42 W	240 LED	369,95 €
342186	■ black	ww nw 3000/4000 K	3000/3100 lm	110 x 600 mm	42 W	240 LED	369,95 €

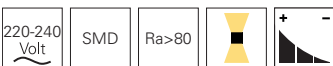

SCULPTORIS 800

- timeless, minimalist design
- high light current
- aluminium
- socket H x Ø: 65 x 275 mm
- max. suspension: 3000 mm
- light colour adjustable via dip switch
- dimmable via phase control or phase cut-off



suitable
ceiling lights
page 63
348184
348185

item	colour	colour temperature	light current	dimensions H x Ø	power	light source	price
342187	□ white	ww nw 3000/4000 K	4000/4100 lm	110 x 800 mm	60 W	384 LED	569,95 €
342188	■ black	ww nw 3000/4000 K	4000/4100 lm	110 x 800 mm	60 W	384 LED	569,95 €

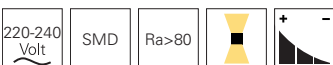



APOLLON

The slim and purist pendant lamp APOLLON fits seamlessly into almost any ambience and provides a rich warm white light in addition to the noble look. The APOLLON is available in two different sizes with a matte surface in black and white.



view from above



view from below

APOLLON

- slim, noble design
- high colour rendition [Ra >90]
- aluminium
- socket L x B x H: 650/850 x 35 x 48 mm
- max. suspension: 3000 mm
- dimmable via phase control or phase cut-off

item	colour	colour temperature	light current	dimensions L x B x H	power	price
342149	<input type="checkbox"/> white	2700 K	1755 lm	1004 x 80 x 8 mm	28 W	319,95 €
342148	<input checked="" type="checkbox"/> black	2700 K	1755 lm	1004 x 80 x 8 mm	28 W	319,95 €
342151	<input type="checkbox"/> white	2700 K	2475 lm	1464 x 80 x 8 mm	42 W	429,95 €
342150	<input checked="" type="checkbox"/> black	2700 K	2475 lm	1464 x 80 x 8 mm	42 W	429,95 €

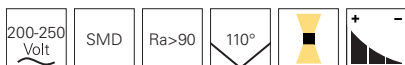

MADERA

The MADERA series is made of first-class European oak wood and impresses with its modern design and mix of materials in private living areas, hotels, restaurants and much more. The noble MADERA luminaires distribute their powerful warm white light in every room and thus also cut an excellent figure as functional and high-quality lighting at reception counters and co.



touch sensor



suitable
ceiling lights
page 89
348147



suitable
wall light
page 196
341248



suitable
table /
floor lights
page 220
346044
343031

MADERA

- modern, exclusive design
- made in Europe from high-quality oak wood of quality class A
- FSC-certified raw material oak wood
- environmentally friendly packaging
- infinitely dimmable via touch sensor
- oak wood | aluminium
- dimensions L x B x H: 900 x 40 x 60 mm
- socket L x B x H: 370 x 50 x 30 mm
- max. suspension: 1000 mm

item	colour	colour temperature	light current	price
342169	■ wood, black	■ ww 3000 K	1190 lm	449,95 €







□ □
page 52



□ □ □ □
□ □ □ □
page 55



□ □ □ □
□ □ □ □
page 56



□ □ □ □
□ □ □ □
page 57



□ □ □
page 59



□ □ □ □
□ □
page 61



□ □
page 63



□
page 64



□
page 64



□ □
page 67



□ □
page 67



□ □
page 69



□ □
page 70



□ □
page 70



□ □
page 71



□ □
page 72



□ □
page 72



□ □
page 73



□
page 74



□
page 74



□
page 75

surface mounted ceiling lights



□ ■
page 76



□ ■
page 76



□ ■
page 77



□ ■
page 78



□ ■
page 78



□ ■
page 79



□ □ ■
page 80



□ □ ■
page 80



□ ■ □
page 81



□
page 82



■ □
page 82



□ □
page 83



□ ■ □
from page 84



□ ■ □
from page 86



■
page 89





ORBIT

The ORBIT is a modern surface-mounted ceiling luminaire that offers more than is apparent at first glance. In addition to its high light output [optionally in warm white or neutral white] and a 360° beam angle for perfect area illumination, the ORBIT can be converted into a chic pendant luminaire via an optional wire suspension. For those who need even more flexibility, the ORBIT can be combined with the ZANIAH series, which is also new.



ORBIT

- modern design
- high light current
- can be converted into a pendant luminaire
- plastic
- dimensions H x Ø: 45 x 350 mm
- socket H x Ø: 40 x 200 mm
- dimmable via phase control or phase cut-off

item	colour	colour temperature	light current	price
401009	<input type="checkbox"/> white	 3000 K	1650 lm	179,95 €
401010	<input type="checkbox"/> white	 4000 K	1760 lm	179,95 €

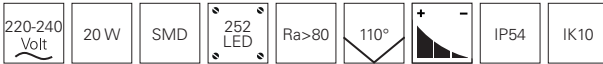

optionales accessories

- 930647** canopy with rope suspension **24,94 €**

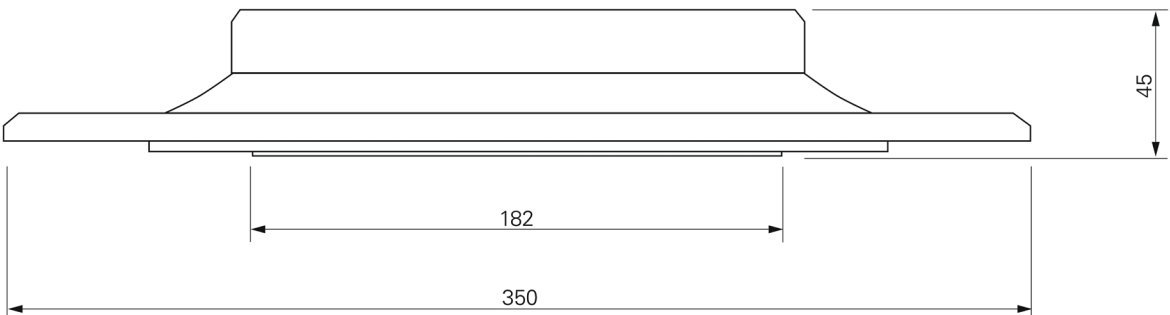





ZANIAH

While most surface-mounted ceiling luminaires focus on flat surfaces and covers, the ZANIAH deliberately places its 360° light source [optionally available as 12W, 18W and 24W versions] in the foreground. This is not only for optical reasons, because the ZANIAH can be combined with the covers of the ORBIT series, which is also new. In this way, not only are different RAL colours available – the ZANIAH itself is also available in eight colour variants per power class.



ZANIAH 12W

- modern design
- interchangeable covers in eight colours
- aluminium
- dimensions H x Ø: 42 x 290 mm
- dimmable via phase control or phase cut-off



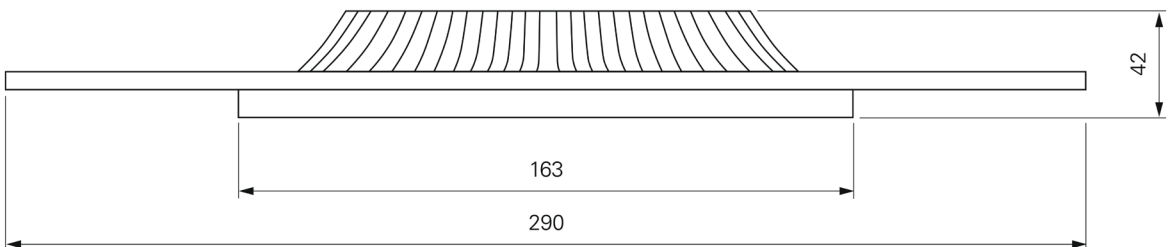













item	colour	colour temperature	light current	price
620040	white	3000 K	1500 lm	114,95 €
620033	silver coloured	3000 K	1500 lm	114,95 €
620038	grey	3000 K	1500 lm	114,95 €
620039	black	3000 K	1500 lm	114,95 €
620036	red	3000 K	1500 lm	114,95 €
620037	yellow	3000 K	1500 lm	114,95 €
620034	blue	3000 K	1500 lm	114,95 €
620035	green	3000 K	1500 lm	114,95 €





ZANIAH 18W

- modern design
- interchangeable covers in eight colours
- aluminium
- dimensions H x Ø: 46 x 370 mm
- dimmable via phase control or phase cut-off

item	colour	colour temperature	light current	price
620048	 white	 3000 K	2000 lm	124,95 €
620041	 silver coloured	 3000 K	2000 lm	124,95 €
620046	 grey	 3000 K	2000 lm	124,95 €
620047	 black	 3000 K	2000 lm	124,95 €
620044	 red	 3000 K	2000 lm	124,95 €
620045	 yellow	 3000 K	2000 lm	124,95 €
620042	 blue	 3000 K	2000 lm	124,95 €
620043	 green	 3000 K	2000 lm	124,95 €

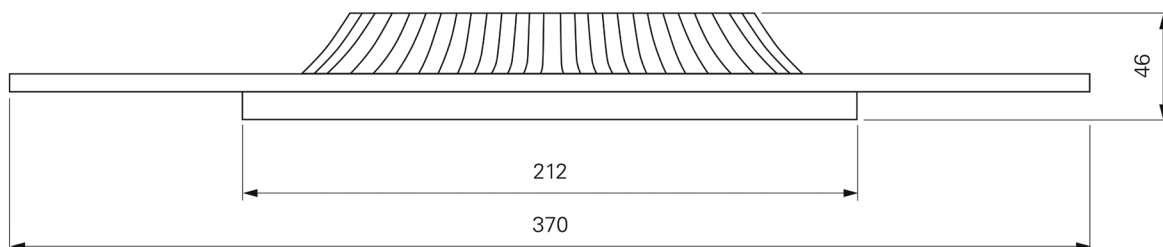



ZANIAH 24W

- modern design
- interchangeable covers in eight colours
- aluminium
- dimensions H x Ø: 46 x 420 mm
- dimmable via phase control or phase cut-off

item	colour	colour temperature	light current	price
620056	white	3000 K	2560 lm	134,95 €
620049	silver coloured	3000 K	2560 lm	134,95 €
620054	grey	3000 K	2560 lm	134,95 €
620055	black	3000 K	2560 lm	134,95 €
620052	red	3000 K	2560 lm	134,95 €
620053	yellow	3000 K	2560 lm	134,95 €
620050	blue	3000 K	2560 lm	134,95 €
620051	green	3000 K	2560 lm	134,95 €

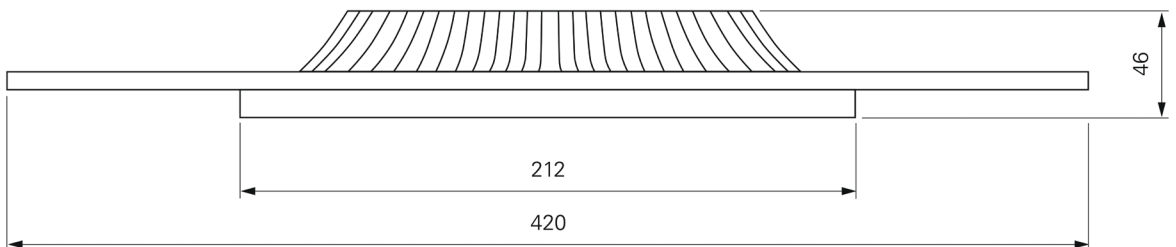



MENKAR

The ceiling lamps of the MENKAR series can be combined great with the MEROPE series – as they come out of the same family. Just like the MEROPE, the MENKAR comes with a fine finished outer ring made of aluminum in white, silver, coffee brown or black colour.



MENKAR 400 + 600 + 800

- timeless design
- high light current [indirect light component ca. 15 - 20%]
- aluminium
- light colour adjustable via dip switch
- dimmable via phase control or phase cut-off

suitable
pendant lights
page 39
342201-342212

item	colour	colour temperature	light current	dimensions H x Ø	power	light source	price
348198	white	WW NW 3000/4000 K	3100/3200 lm	90 x 400 mm	43 W	224 LED	219,95 €
348200	silver brushed	WW NW 3000/4000 K	3100/3200 lm	90 x 400 mm	43 W	224 LED	219,95 €
348201	coffee brushed	WW NW 3000/4000 K	3100/3200 lm	90 x 400 mm	43 W	224 LED	219,95 €
348199	black	WW NW 3000/4000 K	3100/3200 lm	90 x 400 mm	43 W	224 LED	219,95 €
348202	white	WW NW 3000/4000 K	5500/5600 lm	90 x 600 mm	65 W	400 LED	379,95 €
348204	silver brushed	WW NW 3000/4000 K	5500/5600 lm	90 x 600 mm	65 W	400 LED	379,95 €
348205	coffee brushed	WW NW 3000/4000 K	5500/5600 lm	90 x 600 mm	65 W	400 LED	379,95 €
348203	black	WW NW 3000/4000 K	5500/5600 lm	90 x 600 mm	65 W	400 LED	379,95 €
348206	white	WW NW 3000/4000 K	7600/7800 lm	90 x 800 mm	95 W	576 LED	539,95 €
348208	silver brushed	WW NW 3000/4000 K	7600/7800 lm	90 x 800 mm	95 W	576 LED	539,95 €
348209	coffee brushed	WW NW 3000/4000 K	7600/7800 lm	90 x 800 mm	95 W	576 LED	539,95 €
348207	black	WW NW 3000/4000 K	7600/7800 lm	90 x 800 mm	95 W	576 LED	539,95 €

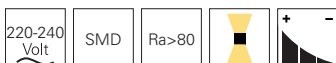



MEROPE

The absolutely timeless MEROPE satisfies not only with the high light current or the very small mounting dimension, but is also an eyecatcher with the elegant outer aluminum ring. You get the choice between sandblasted surface in white or black or brushed surface in silver or trending colour coffee brown finish. Because of the three different sizes 380, 580 or 780mm, the MEROPE fits even more flexible in different surroundings.



MEROPE 400 + 600 + 800

- timeless design
- high light current
- aluminium
- light colour adjustable via dip switch
- dimmable via phase control or phase cut-off



suitable
pendant lights
page 41
342189-342200

item	colour	colour temperature	light current	dimensions H x Ø	power	light source	price
348186	<input type="checkbox"/> white	<input type="checkbox"/> WW <input type="checkbox"/> NW 3000/4000 K	2100/2200 lm	60 x 380 mm	30 W	144 LED	189,95 €
348188	<input type="checkbox"/> silver brushed	<input type="checkbox"/> WW <input type="checkbox"/> NW 3000/4000 K	2100/2200 lm	60 x 380 mm	30 W	144 LED	189,95 €
348189	<input type="checkbox"/> coffee brushed	<input type="checkbox"/> WW <input type="checkbox"/> NW 3000/4000 K	2100/2200 lm	60 x 380 mm	30 W	144 LED	189,95 €
348187	<input type="checkbox"/> black	<input type="checkbox"/> WW <input type="checkbox"/> NW 3000/4000 K	2100/2200 lm	60 x 380 mm	30 W	144 LED	189,95 €
348190	<input type="checkbox"/> white	<input type="checkbox"/> WW <input type="checkbox"/> NW 3000/4000 K	3100/3200 lm	60 x 580 mm	42 W	240 LED	259,95 €
348192	<input type="checkbox"/> silver brushed	<input type="checkbox"/> WW <input type="checkbox"/> NW 3000/4000 K	3100/3200 lm	60 x 580 mm	42 W	240 LED	259,95 €
348193	<input type="checkbox"/> coffee brushed	<input type="checkbox"/> WW <input type="checkbox"/> NW 3000/4000 K	3100/3200 lm	60 x 580 mm	42 W	240 LED	259,95 €
348191	<input type="checkbox"/> black	<input type="checkbox"/> WW <input type="checkbox"/> NW 3000/4000 K	3100/3200 lm	60 x 580 mm	42 W	240 LED	259,95 €
348194	<input type="checkbox"/> white	<input type="checkbox"/> WW <input type="checkbox"/> NW 3000/4000 K	4800/4900 lm	60 x 780 mm	60 W	384 LED	449,95 €
348196	<input type="checkbox"/> silver brushed	<input type="checkbox"/> WW <input type="checkbox"/> NW 3000/4000 K	4800/4900 lm	60 x 780 mm	60 W	384 LED	449,95 €
348197	<input type="checkbox"/> coffee brushed	<input type="checkbox"/> WW <input type="checkbox"/> NW 3000/4000 K	4800/4900 lm	60 x 780 mm	60 W	384 LED	449,95 €
348195	<input type="checkbox"/> black	<input type="checkbox"/> WW <input type="checkbox"/> NW 3000/4000 K	4800/4900 lm	60 x 780 mm	60 W	384 LED	449,95 €





Mit freundlicher Unterstützung von Regionaldirektion für Deutsche Vermögensberatung Pierre Werner / Direktion für Deutsche Vermögensberatung Uwe Liebholz

SCULPTORIS

Thanks to its different versions, the SCULPTORIS series can be optimally integrated both in the bedroom as a surface mounted ceiling luminaire and in the living or dining area as a pendant luminaire.



product video



SCULPTORIS 400 + 600 + 800

- timeless, minimalist design
- high light current
- aluminium
- light colour adjustable via dip switch
- dimmable via phase control or phase cut-off



suitable
pendant
lights
page 43

342183-342188





item	colour	colour temperature	light current	dimensions H x Ø	power	light source	price
348180	<input type="checkbox"/> white	3000/4000 K	1900/2000 lm	100 x 400 mm	30 W	168 LED	269,95 €
348181	<input checked="" type="checkbox"/> black	3000/4000 K	1900/2000 lm	100 x 400 mm	30 W	168 LED	269,95 €
348182	<input type="checkbox"/> white	3000/4000 K	3000/3100 lm	130 x 600 mm	42 W	240 LED	349,95 €
348183	<input checked="" type="checkbox"/> black	3000/4000 K	3000/3100 lm	130 x 600 mm	42 W	240 LED	349,95 €
348184	<input type="checkbox"/> white	3000/4000 K	4000/4100 lm	130 x 800 mm	60 W	384 LED	549,95 €
348185	<input checked="" type="checkbox"/> black	3000/4000 K	4000/4100 lm	130 x 800 mm	60 W	384 LED	549,95 €





HELEN I 3 COLOUR

- plastic
- dimensions H x Ø: 83 x 276 mm
- socket H x Ø: 20 x 251 mm
- light colour adjustable via dip switch



item	colour	colour temperature	light current	price
348051	 silver coloured brushed	   3000/4000/5500 K	1400 lm	84,95 €



 220-240 Volt	15 W	SMD	 84 LED	Ra>80	 115°	IP54
---	------	-----	--	-------	--	------



HELEN II 3 COLOUR

- plastic
- dimensions H x Ø: 89 x 351 mm
- socket H x Ø: 22 x 326 mm
- light colour adjustable via dip switch

item	colour	colour temperature	light current	price
348052	 silver coloured brushed	   3000/4000/5500 K	1800 lm	109,95 €

 220-240 Volt	19 W	SMD	 120 LED	Ra>80	 115°	IP54
---	------	-----	---	-------	--	------

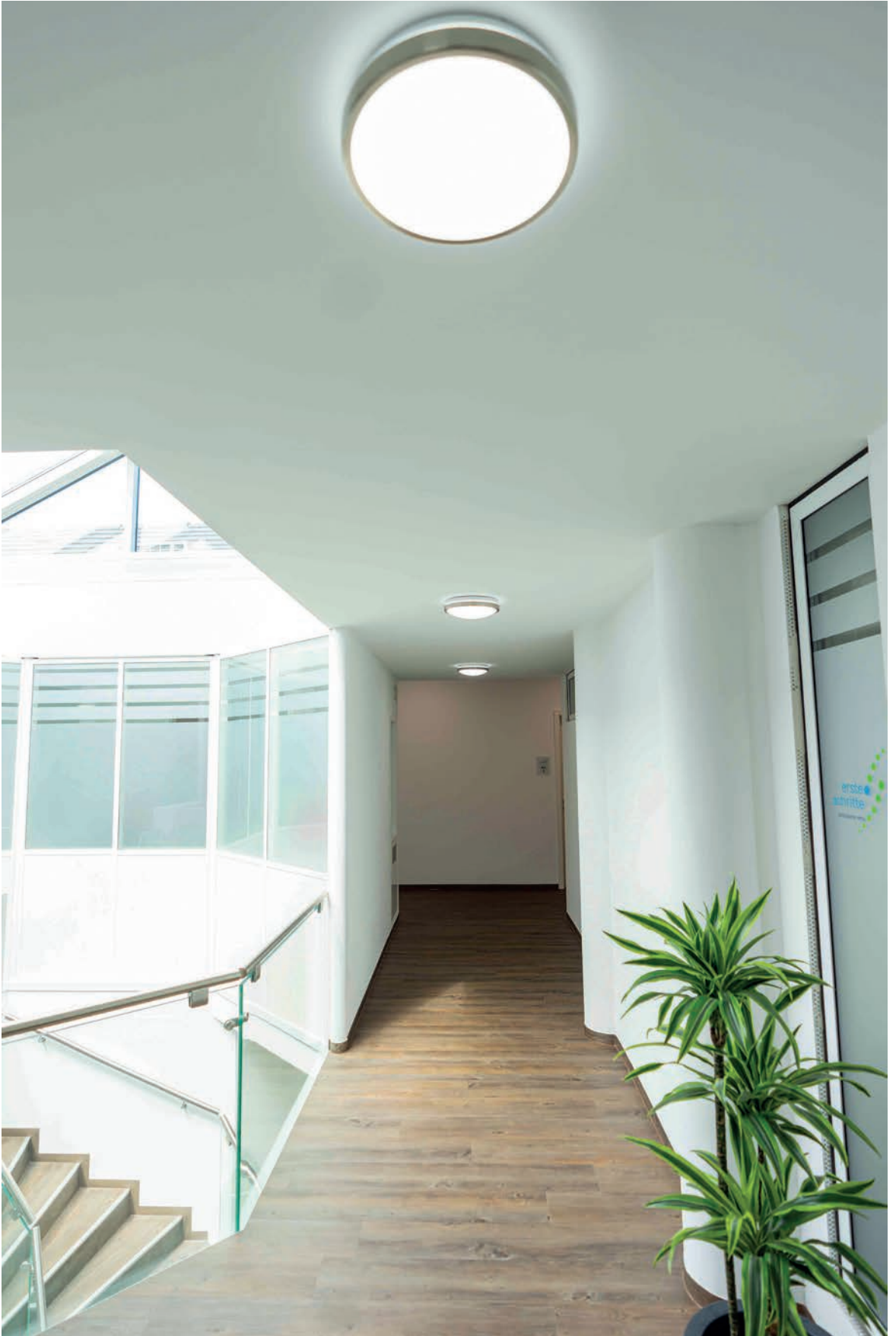



ALTAIS

It takes a lot to bring the ALTAIS series into embarrassment. Thanks to IP54 and impact resistance class IK10, the outdoor luminaires are convincing as slim all-rounders in both public and private areas. The ALTAIS luminaires offer additional flexibility thanks to their integrated motion sensor [programmable via the remote control supplied] and the adjustable light colour for different lighting scenarios.



product video





ALTAIS

- light colour adjustable via dip switch
- plastic

item	colour	colour temperature	light current	dimensions H x Ø	power	price
348141	<input type="checkbox"/> white	WW NW CW 3000/4000/6000 K	1260 lm	48 x 220 mm	12W	69,95 €
348143	<input type="checkbox"/> white	WW NW CW 3000/4000/6000 K	1870 lm	48 x 280 mm	18W	79,95 €
348145	<input type="checkbox"/> white	WW NW CW 3000/4000/6000 K	2715 lm	48 x 330 mm	25W	99,95 €



ALTAIS MOTION

- light colour adjustable via dip switch
- detection area, daylight sensor and light duration can be individualised via remote control
- plastic
- incl. remote control
- incl. motion sensor

item	colour	colour temperature	light current	dimensions H x Ø	power	price
348142	<input type="checkbox"/> white	WW NW CW 3000/4000/6000 K	1260 lm	48 x 220 mm	12W	105,95 €
348144	<input type="checkbox"/> white	WW NW CW 3000/4000/6000 K	1870 lm	48 x 280 mm	18W	119,95 €
348146	<input type="checkbox"/> white	WW NW CW 3000/4000/6000 K	2715 lm	48 x 330 mm	25W	139,95 €

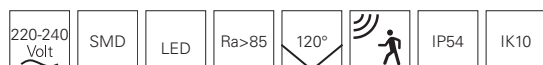



SUBRA

Our new SUBRA lamps can be mounted on the wall just like the ceiling and convince with the slim silhouette. This is not only because of the small installation height of 7cm, but also the orbital light ring which is an additional design element. When it comes to dimming, the SUBRA is even more subtle. You got the choice between the analog TRIAC or the digital DALI version. And there is another version with an adjustable motion sensor.



product video



safe assembly thanks to safety rope

SUBRA

- classic design with illuminated stripe as highlight
- easy mounting by means of clip connection
- high light current
- IP54 ceiling mounting / IP20 wall mounting
- aluminium
- dimensions H x Ø: 70 x 350 mm
- socket H x Ø: 22 x 290 mm

item	colour	colour temperature	light current	power	control	price
401007	<input type="checkbox"/> white	3000 K	2600 lm	28,50 W	TRIAC	249,95 €
401008	<input type="checkbox"/> white	4000 K	2840 lm	28,50 W	TRIAC	249,95 €
401005	<input type="checkbox"/> white	3000 K	2603 lm	28,70 W	motion sensor	299,95 €
401006	<input type="checkbox"/> white	4000 K	2651 lm	28,70 W	motion sensor	299,95 €
401003	<input type="checkbox"/> white	3000 K	2636 lm	28,90 W	DALI	324,95 €
401004	<input type="checkbox"/> white	4000 K	2671 lm	28,90 W	DALI	324,95 €

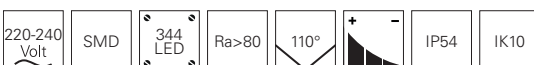



LIBRAE LINEAR I

- aluminium
- luminaire L x Ø: 110 x 65 mm
- socket: 122 x 72 x 30 mm
- dimmable via optional illuminants

item	colour	price
348073	white	39,95 €
348170	black	39,95 €



suitable illuminants on page 767-768



LIBRAE LINEAR II

- aluminium
- luminaire L x Ø: 110 x 65 mm
- socket: 322 x 72 x 30 mm
- dimmable via optional illuminants

item	colour	price
348074	white	74,95 €
348169	black	74,95 €



suitable illuminants on page 767-768



LIBRAE LINEAR III

- aluminium
- luminaire L x Ø: 110 x 65 mm
- socket: 542 x 72 x 30 mm
- dimmable via optional illuminants

item	colour	price
348075	<input type="checkbox"/> white	109,95 €
348171	<input checked="" type="checkbox"/> black	109,95 €



suitable illuminants on page 767-768

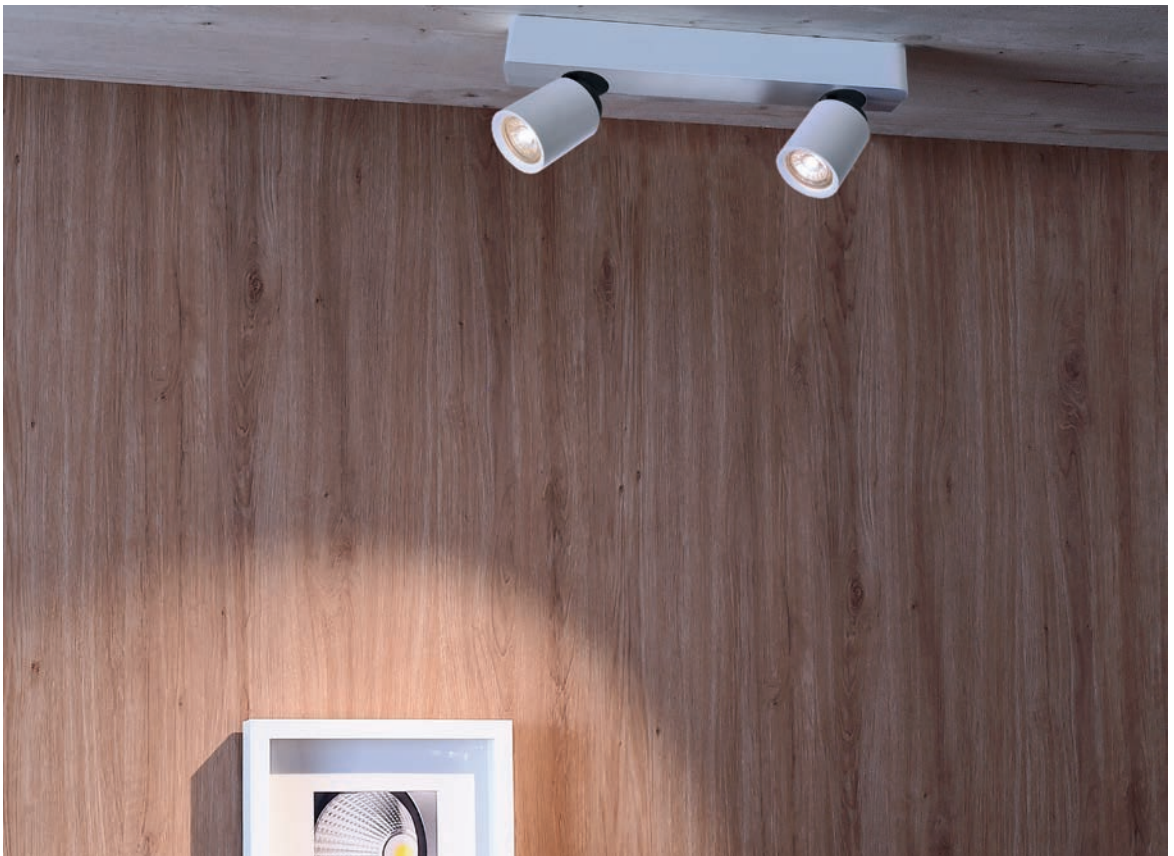

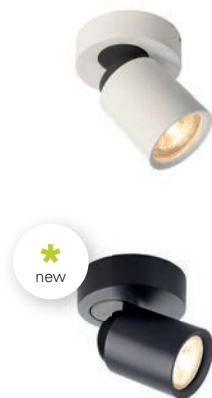

LIBRAE ROUND I

- aluminium
- luminaire H x Ø: 110 x 65 mm
- socket H x Ø: 30 x 102 mm
- dimmable via optional illuminants

item	colour	price
348076	white	39,95 €
348172	black	39,95 €



suitable illuminants on page 767-768



LIBRAE ROUND II

- aluminium
- luminaire H x Ø: 110 x 65 mm
- socket H x Ø: 30 x 173 mm
- dimmable via optional illuminants

item	colour	price
348077	white	74,95 €
348173	black	74,95 €



suitable illuminants on page 767-768



LIBRAE ROUND III

- aluminium
- luminaire H x Ø: 110 x 65 mm
- socket H x Ø: 30 x 212 mm
- dimmable via optional illuminants

item	colour	price
348078	<input type="checkbox"/> white	109,95 €
348174	<input checked="" type="checkbox"/> black	109,95 €



suitable illuminants on page 767-768





INDI I

- aluminium
- luminaire H x Ø: 124 x 100 mm
- socket H x Ø: 25 x 80 mm
- dimmable via optional illuminants

item	colour	price
348085	 silver coloured brushed	32,95 €



suitable illuminants on page 767-768



INDI II

- aluminium
- luminaire H x Ø: 124 x 172 mm
- socket H x Ø: 25 x 135 mm
- dimmable via optional illuminants

item	colour	price
348086	 silver coloured brushed	59,95 €



suitable illuminants on page 767-768



INDI III

- aluminium
- luminaire H x Ø: 124 x 250 mm
- socket H x Ø: 25 x 190 mm
- dimmable via optional illuminants

item	colour	price
348087	<input type="checkbox"/> silver coloured brushed	89,95 €



suitable illuminants on page 767-768





UNI II

- aluminium diecast
- luminaire H x Ø: 103 x 100 mm
- socket H x Ø: 14,5 x 96 mm
- dimmable via phase control or phase cut-off

item	colour	colour temperature	light current	price
348124	white	3000 K	670 lm	149,95 €
348179	black	3000 K	670 lm	149,95 €

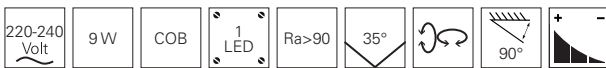

suitable
power
luminaire
page 336
707044
707131



UNI II DOUBLE

- aluminium diecast
- luminaire L x B x H: 212 x 100 x 103 mm
- socket L x B x H: 212 x 20 x 14 mm
- dimmable via phase control or phase cut-off

item	colour	colour temperature	light current	price
348125	white	3000 K	1350 lm	269,95 €
348175	black	3000 K	1350 lm	269,95 €

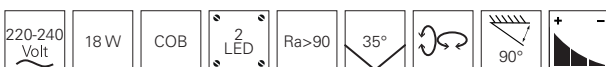



UNI II TRIPLE

- aluminium diecast
- luminaire L x B x H: 324 x 100 x 103 mm
- socket L x B x H: 315 x 25 x 14,5 mm
- dimmable via phase control or phase cut-off

item	colour	colour temperature	light current	price
348107	white	3000 K	2150 lm	379,95 €
348210	black	3000 K	2150 lm	379,95 €

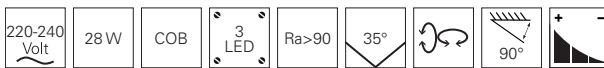

accessories für UNI II series

930339	reflector ring black	11,95 €
930340	reflector ring gold optics	11,95 €
930341	reflector ring chrome	11,95 €
930371	reflector ring II black glossy	10,95 €
930335	cover backside black	3,55 €
930337	cover heatsink black	3,55 €
930306	reflector 50°	10,95 €
930307	honeycomb filter	10,95 €
930308	spread lens 40° clear/satined	10,95 €
930309	softening lens 47° satined	10,95 €
930310	linear spread lens 40°/80° asymmetric clear/satined	10,95 €



UNI II MINI

- aluminium diecast
- luminaire L x Ø: 91 x 75 mm
- socket H x Ø: 44 x 75 mm
- dimmable via phase control or phase cut-off

item	colour	colour temperature	light current	price
348122	white	3000 K	600 lm	129,95 €
348178	black	3000 K	600 lm	129,95 €

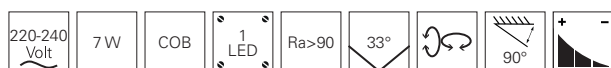

UNI II MINI DOUBLE

- aluminium diecast
- luminaire L x B x H: 160 x 75 x 91 mm
- socket L x B x H: 160 x 75 x 44 mm
- dimmable via phase control or phase cut-off

item	colour	colour temperature	light current	price
348123	white	3000 K	980 lm	209,95 €
348177	black	3000 K	980 lm	209,95 €

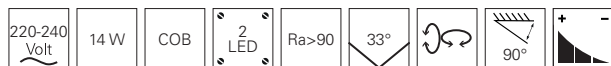

accessories für UNI II MINI series

930331	reflector ring black	10,95 €
930332	reflector ring gold	10,95 €
930333	reflector ring chrome	10,95 €
930381	reflector ring II black	10,95 €
930327	cover backside black	3,55 €
930329	cover heatsink black	3,55 €



UNI II MAX

- aluminium diecast
- luminaire H x Ø: 128 x 125 mm
- socket H x Ø: 62 x 125 mm
- dimmable via phase control or phase cut-off

item	colour	colour temperature	light current	price
348127	white	3000 K	2410 lm	259,95 €
348176	black	3000 K	2410 lm	259,95 €

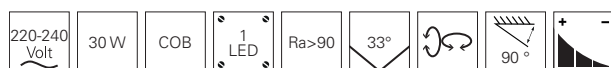

accessories für UNI II MAX

930398	reflector ring black	12,95 €
930399	reflector ring gold	14,95 €
930382	reflector ring II black glossy	10,95 €
930394	cover backside black	10,95 €
930396	cover heatsink black	10,95 €
930390	reflector 24°	12,95 €
930392	reflector 50°	12,95 €



BENGALA

- aluminium
- luminaire H x Ø: 120 x 96 mm
- socket Ø: 96 mm
- dimmable via optional illuminants

item	colour	price
348023	<input type="checkbox"/> white	49,95 €
122416	<input type="checkbox"/> silver coloured brushed	49,95 €
348022	<input type="checkbox"/> black	49,95 €



suitable illuminants on page 767-768



DATO

- aluminium
- luminaire L x B x H: 96 x 96 x 120 mm
- socket L x B: 96 x 96 mm
- dimmable via optional illuminants

item	colour	price
348025	<input type="checkbox"/> white	49,95 €
122417	<input type="checkbox"/> silver coloured brushed	49,95 €
348024	<input type="checkbox"/> black	49,95 €



suitable illuminants on page 767-768



MONA

- aluminium diecast
- dimmable via optional illuminants

item	colour	dimensions L x B x H	power	price
348001	□ white	93 x 93 x 120 mm	1x max.50 W	59,95 €
348002	■ black	93 x 93 x 120 mm	1x max.50 W	59,95 €
348004	□ white	186 x 93 x 120 mm	2x max.50 W	119,95 €
348005	■ black	186 x 93 x 120 mm	2x max.50 W	119,95 €



suitable illuminants on page 767-768





SKY LED

- aluminium
- dimensions L x B x H: 105 x 105 x 105 mm
- dimmable via phase cut-off

item	colour	colour temperature	light current	price
348013	<input type="checkbox"/> white	3000 K	770 lm	134,95 €



NAOS

- concrete
- socket L x B x H: 60 x 40 x 45 mm
- dimmable via optional illuminants

item	colour	dimensions L x B x H / H x Ø	price
348048	<input checked="" type="checkbox"/> grey	70 x 70 x 112 mm	79,95 €
348049	<input checked="" type="checkbox"/> grey	112 x 70 mm	79,95 €



suitable illuminants on page 767-768

DRACONIS

The DRACONIS series from DEKO-LIGHT enables the flexible ceiling lighting for a wide range of applications in the industrial, commercial and logistics sectors. The DRACONIS luminaire is for the optional use as a surface-mounted ceiling luminaire or in a 3-phase track system. The power [45, 55 or 72 W] and light colour [2,700, 3,500 or 4,000 K] can be adjusted via a switch on the back of the housing. In order to integrate the DRACONIS in almost any environment, we offer several lenses for asymmetrical or symmetrical illumination in different beam angles. The maximum light current is 8,215 lumens.



DRACONIS

- light colour and output adjustable via dip switch
- high light current [bis 8200 lm]
- aluminium diecast
- dimensions L x B x H: 578 x 189 x 71 mm
- socket L x B x H: 102 x 88 x 25 mm

item	colour	colour temperature	light current	price
348128	<input type="checkbox"/> white	<input type="checkbox"/> WW <input type="checkbox"/> NW 2700 / 3500 / 4000 K	8215 lm	279,95 €
348099	<input type="checkbox"/> aluminium	<input type="checkbox"/> WW <input type="checkbox"/> NW 2700 / 3500 / 4000 K	8215 lm	279,95 €

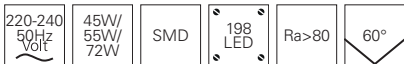

suitable
power
luminaires
page 322
620120
620119



accessories

930577	15° lens asymmetric	9,95 €
930544	20° lens symmetric	9,95 €
930545	30° lens symmetric	9,95 €
930546	90° lens symmetric	9,95 €



suitable
pendant lights
page 13
342177
342178



suitable
power
luminaires
from page 332
707116
707117
707124
707125

LUCEA 10

- aluminium diecast
- dimensions H x Ø: 157 x 65 mm
- dimmable via phase control or phase cut-off
- light colour adjustable via dip switch

item	colour	colour temperature	light current	price
348153	<input type="checkbox"/> white	<input type="checkbox"/> ww <input type="checkbox"/> nw 3000 / 4000 K	930 / 1000 lm	119,95 €
348154	<input checked="" type="checkbox"/> black	<input type="checkbox"/> ww <input type="checkbox"/> nw 3000 / 4000 K	930 / 1000 lm	119,95 €

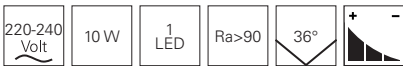

accessories

930679 lens 24° **9,95 €**



LUCEA 15 + 20

- aluminium diecast
- dimensions H x Ø: 178 x 85 mm
- dimmable via phase control or phase cut-off
- light colour adjustable via dip switch

item	colour	colour temperature	light current	power	price
348155	<input type="checkbox"/> white	3000 / 4000 K	1460 / 1500 lm	15 W	139,95 €
348156	<input checked="" type="checkbox"/> black	3000 / 4000 K	1460 / 1500 lm	15 W	139,95 €
348157	<input type="checkbox"/> white	3000 / 4000 K	1930 / 2000 lm	20 W	159,95 €
348158	<input checked="" type="checkbox"/> black	3000 / 4000 K	1930 / 2000 lm	20 W	159,95 €

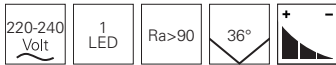

accessories

930680	lens 24°	12,95 €
930681	lens 60°	12,95 €



suitable
pendant lights
page 13
342179-342182



suitable
power
luminaires
from page 333
707118-707121
707126-707129

LUCEA 30

- aluminium diecast
- dimensions H x Ø: 211 x 100 mm
- dimmable via phase control or phase cut-off
- light colour adjustable via dip switch

item	colour	colour temperature	light current	price
348159	<input type="checkbox"/> white	3000 / 4000 K	2700 / 2900 lm	179,95 €
348160	<input checked="" type="checkbox"/> black	3000 / 4000 K	2700 / 2900 lm	179,95 €



accessories

930682	lens 24°	15,95 €
930684	lens 60°	15,95 €



suitable
power
luminaires
page 333
707122
707123





suitable
pendant lights
page 13
342177
342178



suitable
power
luminaires
from page 332
707116
707117
707124
707125

LUCEA 10

- aluminium diecast
- dimensions H x Ø: 218 x 65 mm
- socket H x Ø: 29 x 104,5 mm
- dimmable via phase control or phase cut-off
- light colour adjustable via dip switch

item	colour	colour temperature	light current	price
348161	white	3000 / 4000 K	930 / 1000 lm	129,95 €
348162	black	3000 / 4000 K	930 / 1000 lm	129,95 €

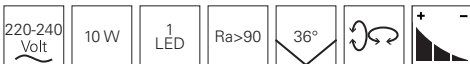

accessories

930679 lens 24° **9,95 €**





suitable
pendant lights
page 13
342179-342182

LUCEA 15 + 20

- aluminium diecast
- dimensions H x Ø: 241 x 85 mm
- socket H x Ø: 29 x 104,5 mm
- dimmable via phase control or phase cut-off
- light colour adjustable via dip switch

item	colour	colour temperature	light current	power	price
348163	□ white	ww nw 3000 / 4000 K	1460 / 1500 lm	15 W	149,95 €
348164	■ black	ww nw 3000 / 4000 K	1460 / 1500 lm	15 W	149,95 €
348165	□ white	ww nw 3000 / 4000 K	1930 / 2000 lm	20 W	169,95 €
348166	■ black	ww nw 3000 / 4000 K	1930 / 2000 lm	20 W	169,95 €

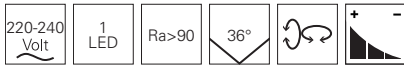

suitable
power
luminaires
from page 333
707118-707121
707126-707129

accessories

930680	lens 24°	12,95 €
930681	lens 60°	12,95 €



LUCEA 30

- aluminium diecast
- dimensions H x Ø: 274 x 100 mm
- socket H x Ø: 29 x 104,5 mm
- dimmable via phase control or phase cut-off
- light colour adjustable via dip switch



suitable
power
luminaires
page 333
707122
707123

item	colour	colour temperature	light current	price
348167	□ white	ww nw 3000 / 4000 K	2700 / 2900 lm	189,95 €
348168	■ black	ww nw 3000 / 4000 K	2700 / 2900 lm	189,95 €

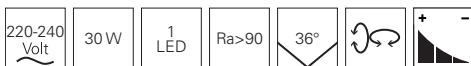

accessories

930682	lens 24°	15,95 €
930684	lens 60°	15,95 €





MADERA

The MADERA series is made of first-class European oak wood and impresses with its modern design and mix of materials in private living areas, hotels, restaurants and many more. The noble MADERA luminaires distribute their powerful warm white light in any room and thus also cut an excellent figure as functional and high-quality lighting at reception counters and more.



MADERA

- modern, exclusive design
- from high-quality oak wood of grade A
- FSC-certified raw material oak wood
- environmentally friendly packaging
- oak wood | aluminium
- dimensions L x B x H: 810 x 135 x 110 mm
- socket L x B x H: 250 x 135 x 30 mm

item	colour	colour temperature	light current	price
348147	■ wood, black	ww 3000 K	1120 lm	439,95 €

220-240 Volt	14 W	LED	Ra>80
-----------------	------	-----	-------



suitable
Pendelleuchte
page 46
342169



suitable
wall light
page 196
341248



suitable
table /
floor lights
page 220
346044
343031



□ □ □
□ □ ■
page 94



□ □ □
□ □ ■
page 94



□ □ □
page 95



□
page 95



□ □ □
page 96



□ □
page 97



□ □
page 97



□ □ □
page 98



□
page 99



□
page 99



□
page 99



□
page 100



■
page 101



□
page 102



□ □
page 102



□ □
page 103



□ □
page 103



□ □
page 103



□
page 104



□
page 104



□ ■
page 105



□
page 105



□
page 106



□
page 106

built in ceiling lights



□
page 106



□
page 107



□ □ □
page 107



□ □ □
page 108



□ □ □ □
from page 111



□ □
from page 114



□ □ □
page 116



□ □
page 142



□ □
from page 118



□ □ □
page 120



□ □
page 120



□ □
page 121





□
page 121



▣
page 123



▣ □
page 123



□ ■ □
page 124



□ □ ■ □
page 125



□ ■
page 126



□ ■
page 126



□ □
page 127



□ □ □
page 128



□ □ □
page 129



□ □ □
page 129



□ □ □
page 130



□ □ □
page 130



□ □ □
page 131



□ □
page 131



□ □
page 132



□ □ □ □
page 133



□
page 134



□ □ □
page 135



□ □
from page 136



□ □
page 138



□ □ □
from page 139



□ ■ □
from page 140



□ ■ □
from page 142



from page 144



from page 146



from page 148



CEILING BUILT-IN RING

- metal
- dimensions H x Ø: 34 x 89 mm
- dimmable via optional illuminants

item	colour	price
686868	<input type="checkbox"/> white	9,95 €
686869	<input type="checkbox"/> silver coloured chrome	9,95 €
686871	<input type="checkbox"/> silver coloured brushed	9,95 €
686880	<input type="checkbox"/> aluminium	9,95 €
686867	<input type="checkbox"/> copper coloured	9,95 €
686864	<input type="checkbox"/> black	9,95 €



accessories

829063 safety spacer **6,95 €**

suitable illuminants on page 765



CEILING BUILT-IN RING GU10

- metal
- dimensions Ø: 89 mm
- dimmable via optional illuminants

item	colour	price
110032	<input type="checkbox"/> white	15,95 €
110033	<input type="checkbox"/> silver coloured chrome	15,95 €
110034	<input type="checkbox"/> silver coloured brushed	15,95 €
110035	<input type="checkbox"/> aluminium	15,95 €
110036	<input type="checkbox"/> copper coloured	15,95 €
110037	<input type="checkbox"/> black	15,95 €

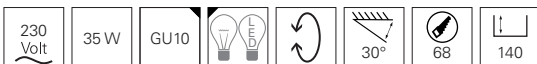

accessories

829063 safety spacer **6,95 €**

suitable illuminants on page 767-768





CEILING BUILT-IN RING

- aluminium diecast
- dimensions H x Ø: 27 x 81 mm
- dimmable via optional illuminants

item	colour	price
449200	<input type="checkbox"/> white	12,95 €
449201	<input type="checkbox"/> silver coloured chrome	12,95 €
449202	<input type="checkbox"/> silver coloured brushed	12,95 €



accessories

829063	safety spacer	6,95 €
---------------	---------------	---------------

suitable illuminants on page 765



CEILING BUILT-IN RING

- aluminium
- dimensions H x Ø: 26 x 92 mm
- dimmable via optional illuminants

item	colour	price
110222	<input type="checkbox"/> silver coloured	17,95 €

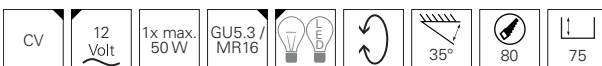

accessories

829063	safety spacer	6,95 €
---------------	---------------	---------------

suitable illuminants on page 765



CEILING BUILT-IN RING

- aluminium diecast
- dimensions L x B x H: 82 x 82 x 27 mm
- dimmable via optional illuminants

item	colour	price
449210	<input type="checkbox"/> white	12,95 €
449211	<input type="checkbox"/> silver coloured chrome	12,95 €
449212	<input type="checkbox"/> silver coloured brushed	12,95 €



accessories

829063	safety spacer	6,95 €
---------------	---------------	---------------

suitable illuminants on page 765



With the kind support of Göbel's Schlosshotel / 36289 Friedewald



ALIOTH ROUND

- aluminium diecast
- dimensions H x Ø: 25 x 85 mm
- dimmable via optional illuminants

item	colour	price
110027	<input type="checkbox"/> white	16,95 €
110028	<input type="checkbox"/> silver coloured	16,95 €



accessories

829063 safety spacer **6,95 €**

suitable illuminants on page 765



ALIOTH ANGULAR

- aluminium diecast
- dimensions L x B : 90 x 90 mm
- dimmable via optional illuminants

item	colour	price
110029	<input type="checkbox"/> white	16,95 €
110030	<input type="checkbox"/> silver coloured	16,95 €



accessories

829063 safety spacer **6,95 €**

suitable illuminants on page 765



CEILING BUILT-IN RING

- aluminium diecast
- dimensions H x Ø: 42 x 84 mm
- dimmable via optional illuminants

item	colour	price
110000	<input type="checkbox"/> white	19,95 €
110001	<input type="checkbox"/> silver coloured	19,95 €
110002	<input type="checkbox"/> silver coloured chrome	19,95 €



accessories

829063 safety spacer **6,95 €**

suitable illuminants on page 765



ALGOL I

- aluminium diecast
- dimensions L x B x H: 100 x 100 x 40 mm
- dimmable via optional illuminants



item	colour	price
110003	<input type="checkbox"/> white	17,95 €



accessories

829063	safety spacer	6,95 €
---------------	---------------	---------------

suitable illuminants on page 765

ALGOL II

- aluminium diecast
- dimensions L x B x H: 185 x 100 x 40 mm
- dimmable via optional illuminants



item	colour	price
110004	<input type="checkbox"/> white	33,95 €



accessories

829063	safety spacer	6,95 €
---------------	---------------	---------------

suitable illuminants on page 765

ENIF

- aluminium diecast
- dimensions H x Ø: 40 x 100 mm
- dimmable via optional illuminants



item	colour	price
110007	<input type="checkbox"/> white	17,95 €



accessories

829063	safety spacer	6,95 €
---------------	---------------	---------------

suitable illuminants on page 765

MIZAR I

- aluminium diecast
- dimensions H x Ø: 41 x 85 mm
- dimmable via optional illuminants

item	colour	price
110010	<input type="checkbox"/> white	17,95 €



accessories

829063	safety spacer	6,95 €
---------------	---------------	---------------

suitable illuminants on page 765



With the kind support of Alitherme Waldbrunn / Ziegler Technics buero@ziegler-technics.de

MIZAR II

- aluminium diecast
- dimensions H x Ø: 33 x 80 mm
- dimmable via optional illuminants

item	colour	price
110011	■ black	17,95 €



accessories

829063	safety spacer	6,95 €
180515	power supply dimmable 12V AC 0-70 W	19,95 €

suitable illuminants on page 765



cover

930079	cover angular metal silver satined 83 x 83 x 4 mm	10,95 €
930075	cover angular metal white 83 x 83 x 4 mm	10,95 €
930077	cover angular metal chrome look 83 x 83 x 4 mm	10,95 €
930100	cover angular metal silver brushed 83 x 83 x 4 mm	10,95 €
930078	cover round metal silver satined 83 x 4 mm	10,95 €
930074	cover round metal white 83 x 4 mm	10,95 €
930076	cover round metal chrome look 83 x 4 mm	10,95 €
930099	cover round metal silver brushed 83 x 4 mm	10,95 €



ALCOR

- stainless steel
- dimensions H x Ø: 106 x 85 mm
- dimmable via optional illuminants

item	colour	price
110014	■ silver coloured brushed	18,95 €



suitable illuminants on page 765



DENE B

- dimensions H x Ø: 148 x 100 mm
- dimmable via optional illuminants

item	colour	price
110015	□ white	16,95 €
110016	■ silver coloured brushed	16,95 €

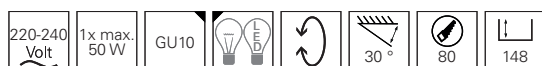

accessories

829063	safety spacer	6,95 €
---------------	---------------	---------------

suitable illuminants on page 767-768

ALTAIR

- aluminium diecast
- dimensions H x Ø: 35 x 85 mm
- dimmable via optional illuminants



item	colour		price
110017	<input type="checkbox"/> white	round	12,95 €
110018	<input type="checkbox"/> white	angular	12,95 €



accessories

829063 safety spacer **6,95 €**

suitable illuminants on page 765

ARKTUR

- aluminium diecast
- dimensions H x Ø: 43 x 93 mm
- dimmable via optional illuminants



item	colour		price
110019	<input type="checkbox"/> white	round	17,95 €
110020	<input type="checkbox"/> white	angular	17,95 €

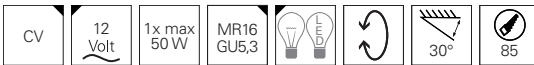

accessories

829063 safety spacer **6,95 €**

suitable illuminants on page 765

SIRRAH

- aluminium diecast
- dimensions H x Ø: 35 x 92 mm
- dimmable via optional illuminants



item	colour		price
110021	<input type="checkbox"/> white	round	20,95 €
110022	<input type="checkbox"/> white	angular	20,95 €



accessories

829063 safety spacer **6,95 €**

suitable illuminants on page 765



KARDAN I

- aluminium
- dimensions L x B x H: 98 x 98 x 90 mm
- dimmable via optional illuminants

item	colour	price
110100	 silver coloured brushed	28,95 €



accessories

829063	safety spacer	6,95 €
---------------	---------------	---------------

suitable illuminants on page 765



KARDAN II

- aluminium
- dimensions L x B x H: 178 x 98 x 90 mm
- dimmable via optional illuminants

item	colour	price
110101	 silver coloured brushed	50,95 €



accessories

829063	safety spacer	6,95 €
---------------	---------------	---------------

suitable illuminants on page 765



CEILING BUILT-IN RING

- aluminium
- dimensions L x B x H: 92 x 92 x 26 mm
- dimmable via optional illuminants

item	colour	price
110421	silver coloured brushed	20,95 €
110427	black	20,95 €



accessories

829063	safety spacer	6,95 €
---------------	---------------	---------------

suitable illuminants on page 765



CEILING BUILT-IN RING

- aluminium
- dimensions L x B x H: 175 x 92 x 26 mm
- dimmable via optional illuminants

item	colour	price
111821	silver coloured brushed	35,95 €

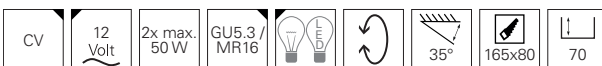

accessories

829063	safety spacer	6,95 €
---------------	---------------	---------------

suitable illuminants on page 765

CEILING BUILT-IN RING

- gypsum
- dimensions H x Ø: 46 x 130 mm
- dimmable via optional illuminants

item	colour	price
110501	<input type="checkbox"/> white	24,95 €



accessories

829063 safety spacer **6,95 €**

suitable illuminants on page 765



CEILING BUILT-IN RING

- gypsum
- dimensions L x B x H: 120 x 120 x 55 mm
- dimmable via optional illuminants

item	colour	price
110500	<input type="checkbox"/> white	24,95 €



accessories

829063 safety spacer **6,95 €**

suitable illuminants on page 765



CEILING BUILT-IN RING

- gypsum
- dimensions H x Ø: 60 x 155 mm
- dimmable via optional illuminants

item	colour	price
110503	<input type="checkbox"/> white	42,95 €



accessories

829063 safety spacer **6,95 €**

suitable illuminants on page 765



CEILING BUILT-IN RING

- stainless steel
- dimensions H x Ø: 35 x 85 mm
- dimmable via optional illuminants



item	colour	price
122420	<input type="checkbox"/> silver coloured brushed	17,95 €



suitable illuminants on page 765



CEILING BUILT-IN RING

- aluminium diecast
- dimensions H x Ø: 43 x 102 mm
- dimmable via optional illuminants

item	colour	price
126070	<input type="checkbox"/> white	17,95 €
126074	<input type="checkbox"/> aluminium	17,95 €
126073	<input type="checkbox"/> silver coloured brushed	17,95 €



accessories

829063	safety spacer	6,95 €
---------------	---------------	---------------

suitable illuminants on page 765



COB 95

- aluminium
- dimensions H x Ø: 46 x 108 mm
- dimmable via phase control or phase cut-off

item	colour	colour temperature	light current	price
565067	<input type="checkbox"/> white	3000 K	820 lm	95,95 €
565070	<input type="checkbox"/> silver coloured brushed	3000 K	820 lm	95,95 €
565068	<input type="checkbox"/> white	4000 K	860 lm	95,95 €
565071	<input type="checkbox"/> silver coloured brushed	4000 K	860 lm	95,95 €



accessories

829063	safety spacer	6,95 €
180512	power supply 350 mA 0,7-18,0 W	26,95 €
862203	power supply dimmable 350 mA 6,3-12,0 W	39,95 €





Foto: Daniel Wieser . Architekturfotografie, Karlsruhe

ACRUX

All luminaires in the ACRUX series have a special feature; the light temperature [3000, 4000, 6000 K] can be set before installation with the switch on the back. This allows a lot of flexibility in the planning phase. The luminous intensity can be individually regulated by phase angle control. The cover supplied can be easily removed if necessary so that the luminaire can also be installed in its housing colour [white]. The integrated diffuser reduces glare and creates a pleasant lighting situation.



switch for setting
the light temperature



3000 K



4000 K



6000 K



565315
incl. cover silver coloured



565362
incl. cover black

ACRUX 68

- plastic
- dimensions H x Ø: 57,5 x 95,0 mm
- white basic housing can also be used without coloured cover ring
- incl. optional monterbarer cover [silver coloured or black]
- dimmable via phase control or phase cut-off
- light colour adjustable via dip switch



item	colour	colour temperature	light current	price
565315	<input type="checkbox"/> <input type="checkbox"/> white/silver coloured	<input type="checkbox"/> WW <input type="checkbox"/> NW <input type="checkbox"/> CW 3000/4000/6000 K	630 lm	29,95 €
565362	<input type="checkbox"/> <input type="checkbox"/> white/black	<input type="checkbox"/> WW <input type="checkbox"/> NW <input type="checkbox"/> CW 3000/4000/6000 K	630 lm	29,95 €

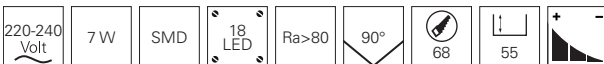

accessories

930652 cover ring black for AcruX 68 **4,95 €**

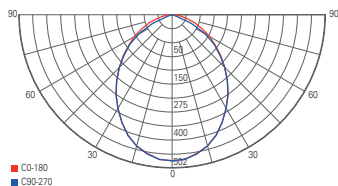

light distribution curve

ACRUX 90

- plastic
- dimensions H x Ø: 58,0 x 113,0 mm
- white basic housing can also be used without coloured cover ring
- incl. optional monterbarer cover [silver coloured or black]
- dimmable via phase control or phase cut-off
- light colour adjustable via dip switch



item	colour	colour temperature	light current	price
565316	<input type="checkbox"/> <input type="checkbox"/> white/silver coloured	<input type="checkbox"/> <input type="checkbox"/> <input type="checkbox"/> 3000/4000/6000 K	760 lm	34,95 €
565363	<input type="checkbox"/> <input type="checkbox"/> white/black	<input type="checkbox"/> <input type="checkbox"/> <input type="checkbox"/> 3000/4000/6000 K	760 lm	34,95 €

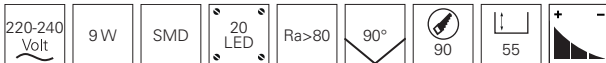

accessories

930653 cover ring black for Acrux 80 **5,95 €**

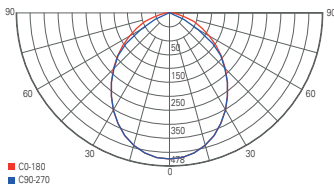

light distribution curve

ACRUX 120

- plastic
- dimensions H x Ø: 65,8 x 145,0 mm
- white basic housing can also be used without coloured cover ring
- incl. optional monterbarer cover [silver coloured or black]
- dimmable via phase control or phase cut-off
- light colour adjustable via dip switch



item	colour	colour temperature	light current	price
565317	<input type="checkbox"/> <input type="checkbox"/> white/silver coloured	<input type="checkbox"/> <input type="checkbox"/> <input type="checkbox"/> 3000/4000/6000 K	1370 lm	39,95 €
565364	<input type="checkbox"/> <input type="checkbox"/> white/black	<input type="checkbox"/> <input type="checkbox"/> <input type="checkbox"/> 3000/4000/6000 K	1370 lm	39,95 €

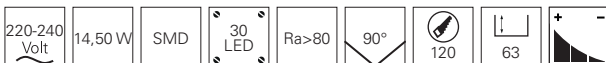

accessories

930654 cover ring black for Acrux 120 **6,95 €**

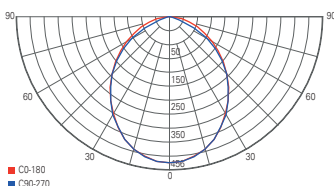

light distribution curve

ACRUX 145

- plastic
- dimensions H x Ø: 68,5 x 174,0 mm
- white basic housing can also be used without coloured cover ring
- incl. optional montierbarer cover [silver coloured or black]
- dimmable via phase control or phase cut-off
- light colour adjustable via dip switch



item	colour	colour temperature	light current	price
565318	<input type="checkbox"/> <input type="checkbox"/> white/silver coloured	WW NW CW 3000/4000/6000 K	1570 lm	44,95 €
565365	<input type="checkbox"/> <input type="checkbox"/> white/black	WW NW CW 3000/4000/6000 K	1570 lm	44,95 €

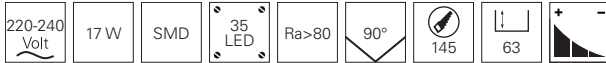

accessories

930655 cover ring black for Acrux 145 **7,95 €**

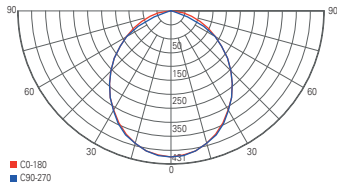

ACRUX 195

- plastic
- dimensions H x Ø: 84,0 x 244,0 mm
- white basic housing can also be used without coloured cover ring
- incl. optional montierbarer cover [silver coloured or black]
- dimmable via phase control or phase cut-off
- light colour adjustable via dip switch



item	colour	colour temperature	light current	price
565332	<input type="checkbox"/> <input type="checkbox"/> white/silver coloured	WW NW CW 3000/4000/6000 K	2670 lm	59,95 €
565366	<input type="checkbox"/> <input type="checkbox"/> white/black	WW NW CW 3000/4000/6000 K	2670 lm	59,95 €

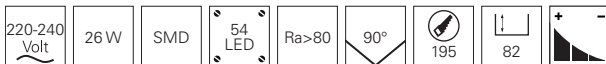

accessories

930656 cover ring black for Acrux 195 **9,95 €**

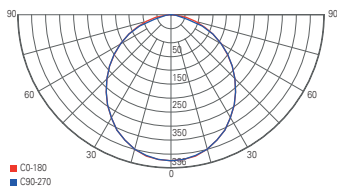

ZAURAK

Recessed ceiling luminaires can be discreetly integrated into private and commercial spaces, but when they need to be replaced, the existing ceiling cut-out can become a problem. The ZAURAK series comes with an adjustable mounting bracket that allows larger or smaller ceiling cut-outs to be used. In addition, the ZAURAK has a low installation depth for universal use. The scope of delivery includes two interchangeable cover rings in silver and black.



ZAURAK 180

- light colour and output adjustable via dip switch
- white basic housing can also be used without coloured cover ring
- incl. optional cover [silver coloured and black]
- adjustable cut-out dimension: 65-160 mm
- plastic
- dimensions H x Ø: 21 x 180 mm

item	colour	colour temperature	light current	price
565327	<input type="checkbox"/> <input type="checkbox"/> <input checked="" type="checkbox"/> white/silver coloured/black	<input checked="" type="checkbox"/> <input type="checkbox"/> <input type="checkbox"/> 3000/4000/5700 K	1060 lm	46,95 €

220-240 Volt	8/12 W	SMD	52 LED	Ra>80	110°	65	IP44
--------------	--------	-----	--------	-------	------	----	------

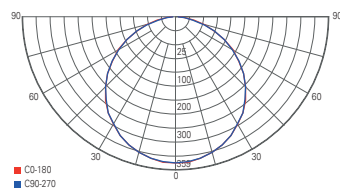

light distribution curve

ZAURAK 220

- light colour and output adjustable via dip switch
- white basic housing can also be used without coloured cover ring
- incl. optional cover [silver coloured and black]
- adjustable cut-out dimension: 120-200 mm
- plastic
- dimensions H x Ø: 22 x 220 mm



item	colour	colour temperature	light current	price
565328	<input type="checkbox"/> <input type="checkbox"/> <input checked="" type="checkbox"/> white/silver coloured/black	<input checked="" type="checkbox"/> <input type="checkbox"/> <input type="checkbox"/> 3000/4000/5700 K	1750 lm	56,95 €

220-240 Volt	12/18 W	SMD	65 LED	Ra>80	110°	120	IP44
--------------	---------	-----	--------	-------	------	-----	------

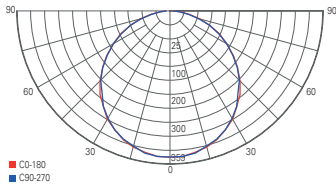

light distribution curve

ZAURAK 300

- light colour and output adjustable via dip switch
- white basic housing can also be used without coloured cover ring
- incl. optional cover [silver coloured and black]
- adjustable cut-out dimension: 150-270 mm
- plastic
- dimensions H x Ø: 25 x 300 mm



item	colour	colour temperature	light current	price
565329	<input type="checkbox"/> <input type="checkbox"/> <input checked="" type="checkbox"/> white/silver coloured/black	<input checked="" type="checkbox"/> <input type="checkbox"/> <input type="checkbox"/> 3000/4000/5700 K	2420 lm	79,95 €

220-240 Volt	18/25 W	SMD	91 LED	Ra>80	110°	150	IP44
--------------	---------	-----	--------	-------	------	-----	------

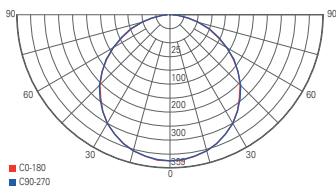

light distribution curve



LED PANEL 8 + 12 + 16

- aluminium diecast
- dimmable via optional power supply

item	colour	colour temperature	light current	dimensions H x Ø	Strom	voltage	power	cutout Ø	inst. depth	price
565082		2700 K	590 lm	18 x 145 mm	350 mA	17-18 V	7 W	135 mm	18 mm	39,95 €
565083		2700 K	590 lm	18 x 145 mm	350 mA	17-18 V	7 W	135 mm	18 mm	39,95 €
565084		4000 K	610 lm	18 x 145 mm	350 mA	17-18 V	7 W	135 mm	18 mm	39,95 €
565085		4000 K	610 lm	18 x 145 mm	350 mA	17-18 V	7 W	135 mm	18 mm	39,95 €
565088		2700 K	820 lm	20 x 180 mm	350 mA	23-24 V	9 W	169 mm	20 mm	55,95 €
565089		2700 K	820 lm	20 x 180 mm	350 mA	23-24 V	9 W	169 mm	20 mm	55,95 €
565090		4000 K	870 lm	20 x 180 mm	350 mA	23-24 V	9 W	169 mm	20 mm	55,95 €
565091		4000 K	870 lm	20 x 180 mm	350 mA	23-24 V	9 W	169 mm	20 mm	55,95 €
565094		2700 K	1260 lm	20 x 236 mm	700 mA	17-18 V	13 W	222 mm	20 mm	77,95 €
565095		2700 K	1260 lm	20 x 236 mm	700 mA	17-18 V	13 W	222 mm	20 mm	77,95 €
565096		4000 K	1150 lm	20 x 236 mm	700 mA	17-18 V	13 W	222 mm	20 mm	77,95 €
565097		4000 K	1150 lm	20 x 236 mm	700 mA	17-18 V	13 W	222 mm	20 mm	77,95 €



accessories for **565082-565085**

180512	power supply 350 mA 0,7-18,0 W	26,95 €
862202	power supply dimmable 350 mA 3,9-9,0 W	31,95 €
862190	power supply dimmable mit Dali1/Dali2, Intelli-Push 3,2-12,0 W	64,95 €

accessories for **565088-565091**

180512	power supply 350 mA 0,7-18,0 W	26,95 €
862203	power supply dimmable 350 mA 6,3-12,0 W	39,95 €
862190	power supply dimmable mit Dali1/Dali2, Intelli-Push 3,2-12,0 W	64,95 €

accessories for **565094-565097**

180514	power supply 700 mA 1,4-18,0 W	26,95 €
862207	power supply dimmable 700 mA 9,8-20,0 W	46,95 €
862190	power supply dimmable mit Dali1/Dali2, Intelli-Push 3,2-12,0 W	64,95 €



LED PANEL 8 + 16 + 8

- aluminium diecast
- dimmable and colour temperature adjustable via optional controller

item	colour	colour temperature	light current	dimensions H x Ø	power	cutout Ø	installation depth	price
565102	<input type="checkbox"/> white	ww cw 2700-6000 K	470 lm	18 x 145 mm	8,50 W	135 mm	18 mm	52,95 €
565103	<input type="checkbox"/> white	ww cw 2700-6000 K	940 lm	20 x 236 mm	15,00 W	222 mm	20 mm	82,95 €
565248	<input type="checkbox"/> white	RGB ww 3000 K	140 lm	18 x 145 mm	8,00 W	135 mm	18 mm	52,95 €



accessories for **565102**

862233	power supply 24V 12,00 W	22,95 €
862166	power supply 24V 100,00 W	104,95 €
843057	RF controller Set White 12/24/48V	109,95 €

accessories for **565103**

862234	power supply 24V 20,00 W	26,95 €
862168	power supply 24V 150,00 W	144,95 €
843057	RF controller Set White 12/24/48V	109,95 €





accessories for **565248**

862233	power supply 24V 12,0 W	22,95 €
862166	power supply 24V 100,0 W	104,95 €
843059	RF controller Set RGB+White 12/24/48V	119,95 €



LED PANEL ROUND III 6 + 12

- aluminium diecast
- dimmable via optional power supply

item	colour	colour temperature	light current	dimensions H x Ø	voltage	power	cutout Ø	inst. depth	price
565229	<input type="checkbox"/> white	 3000 K	620 lm	34 x 106 mm	18 V	6 W	90 mm	32 mm	69,95 €
565230	<input type="checkbox"/> white	 4000 K	630 lm	34 x 106 mm	18 V	6 W	90 mm	32 mm	69,95 €
565231	<input type="checkbox"/> white	 3000 K	1310 lm	36 x 140 mm	36 V	13 W	125 mm	34 mm	89,95 €
565232	<input type="checkbox"/> white	 4000 K	1320 lm	36 x 140 mm	36 V	13 W	125 mm	34 mm	89,95 €



accessories for **565229, 565230**

862223	power supply 350 mA 2-35V 0,7-12,0 W	25,95 €
862202	power supply dimmable 350 mA 11-26V 3,9-9,0 W	31,95 €
862190	power supply MULTI-CC DALI1/2/Intelli-Push dimmable 15-34V 5,2-12,0 W	64,95 €

accessories for **565231, 565232**

180512	power supply 350 mA 2-52V 0,7-18,0 W	26,95 €
862204	power supply dimmable 350 mA 28-57V 9,8-20,0 W	44,95 €
862191	power supply MULTI-CC DALI DALI1/2/Intelli-Push dimmable 20-60V 7,0-20,0 W	69,95 €



LED PANEL ROUND III 20 + 26

- aluminium diecast
- dimmable via optional power supply

item	colour	colour temperature	light current	dimensions H x Ø	voltage	power	cutout Ø	inst. depth	price
565233	<input type="checkbox"/> white	<input checked="" type="checkbox"/> 3000 K	1980 lm	38 x 180 mm	28 V	20 W	160 mm	36 mm	109,95 €
565234	<input type="checkbox"/> white	<input checked="" type="checkbox"/> 4000 K	1970 lm	38 x 180 mm	28 V	20 W	160 mm	36 mm	109,95 €
565235	<input type="checkbox"/> white	<input checked="" type="checkbox"/> 3000 K	2680 lm	38 x 230 mm	37 V	26 W	200 mm	36 mm	134,95 €
565236	<input type="checkbox"/> white	<input checked="" type="checkbox"/> 4000 K	2690 lm	38 x 230 mm	37 V	26 W	200 mm	36 mm	134,95 €



accessories for **565233, 565234**

862198	power supply 700 mA 21-43V 14,7-30,0 W	31,95 €
862207	power supply dimmable 700 mA 14,0-28,0V 9,8-20,0 W	46,95 €
862191	power supply MULTI-CC DALI1/2/Intelli-Push dimmable 20-36V 14,0-25,0 W	69,95 €

accessories for **565235, 565236**

862198	power supply 700 mA 21-43V 14,7-30,0 W	31,95 €
862208	power supply dimmable 700 mA 28-56V 19,6-40,0 W	53,95 €
862192	power supply MULTI-CC DALI1/2/Intelli-Push dimmable 25-64V 17,5-45,0 W	74,95 €



COB 68 IP65

- aluminium diecast
- dimensions H x Ø: 44 x 78 mm
- dimmable via optional power supply

item	colour	colour temperature	light current	price
565108	<input type="checkbox"/> white	2700 K	670 lm	59,95 €
565109	<input type="checkbox"/> grey	2700 K	670 lm	59,95 €
565110	<input type="checkbox"/> white	4200 K	730 lm	59,95 €
565111	<input type="checkbox"/> grey	4200 K	730 lm	59,95 €

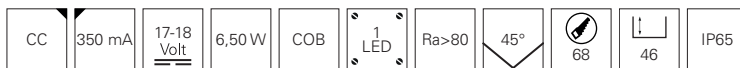

accessories

829063	safety spacer	6,95 €
180512	power supply 350 mA 0,7-18,0 W	26,95 €
862202	power supply dimmable 350 mA 3,9 - 9 ,0 W	31,95 €



PUNTO LUMI

- aluminium
- dimensions H x Ø: 25 x 30 mm

item	colour	colour temperature	light current	price
565172	<input type="checkbox"/> white	3000 K	40 lm	17,95 €
565173	<input type="checkbox"/> silver coloured chrome	3000 K	40 lm	17,95 €

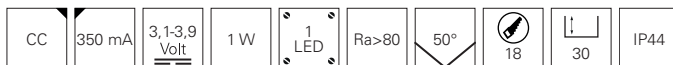

accessories

872628	power supply 350 mA 0,7 - 6,0 W	18,95 €
---------------	-------------------------------------	----------------



COB 68 CCT

- aluminium
- dimensions H x Ø: 46 x 78 mm
- dimmable and colour temperature adjustable via optional controller

item	colour	colour temperature	light current	price
565193	<input type="checkbox"/> white	<input type="checkbox"/> ww <input type="checkbox"/> cw 2500-6500 K	534 lm	64,95 €
565198	<input type="checkbox"/> silver coloured brushed	<input type="checkbox"/> ww <input type="checkbox"/> cw 2500-6500 K	700 lm	64,95 €

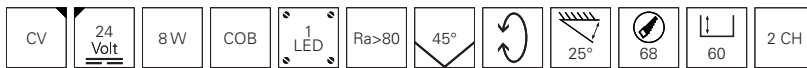

accessories

829063	safety spacer	6,95 €
862233	power supply 24V DC 12,0 W	22,95 €
862166	power supply 24V DC 100,0 W	104,95 €
843057	RF controller Set White 12/24/48V	109,95 €



COB 95 CCT

- aluminium
- dimensions H x Ø: 65 x 108 mm
- dimmable and colour temperature adjustable via optional controller

item	colour	colour temperature	light current	price
565194	<input type="checkbox"/> white	<input type="checkbox"/> ww <input type="checkbox"/> cw 2500-6500 K	1118 lm	109,95 €

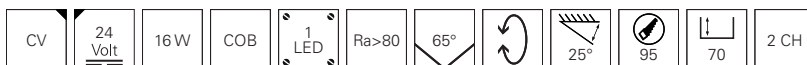

accessories

829063	safety spacer	6,95 €
862234	power supply 24V DC 20,0 W	26,95 €
862168	power supply 24V DC 150,0 W	144,95 €
843057	RF controller Set White 12/24/48V	109,95 €



COB 68 ACRYL

A spotlight with that certain something: thanks to its acrylic ring, the COB 68 ACRYL emits light not only downwards but also softly to the side. The resulting play of light on the ceiling makes for a discreet but effective eye-catcher and bathes every room in a cosy ambience.



COB 68 ACRYL

- acrylic glass, aluminium
- dimensions H x Ø: 60 x 78 mm
- dimmable and colour temperature adjustable via optional controller

item	colour	colour temperature	light current	price
565247	colourless satined	2400-6500 K	590 lm	65,95 €

CV		8 W	COB		Ra>80			
----	--	-----	-----	--	-------	--	--	--

accessories

930270	acrylic ring round 90 mm	19,95 €
930271	acrylic ring angular 90 x 90 mm	19,95 €
829063	safety spacer	6,95 €
862233	power supply 24V DC 12,0 W	22,95 €
862166	power supply 24V DC 100,0 W	104,95 €
843057	RF controller Set White 12/24/48V	109,95 €



COB 68 ACRYL

- acrylic glass, aluminium
- dimensions H x Ø: 54 x 78 mm
- dimmable via optional power supply

item	colour	colour temperature	light current	price
565195	colourless satined	2700 K	675 lm	65,95 €

CC		6,50 W	COB		Ra>80			
----	--	--------	-----	--	-------	--	--	--

accessories

930270	acrylic ring round 90 mm	19,95 €
930271	acrylic ring angular 90 x 90 mm	19,95 €
829063	safety spacer	6,95 €
180512	power supply 350 mA 0,7-18,0 W	26,95 €
862202	power supply dimmable 350 mA 3,9 - 9 ,0 W	31,95 €





SATURN

- aluminium
- dimensions H x Ø: 49 x 100 mm
- dimmable via optional power supply

item	colour	colour temperature	light current	price
565200	<input type="checkbox"/> white chrome	2700 K	700 lm	69,95 €
565201	<input checked="" type="checkbox"/> black chrome	2700 K	700 lm	69,95 €
565202	<input type="checkbox"/> white chrome	4000 K	720 lm	69,95 €
565203	<input checked="" type="checkbox"/> black chrome	4000 K	720 lm	69,95 €



accessories

829063	safety spacer	6,95 €
180512	power supply 350 mA 0,7 - 18,0 W	26,95 €
862202	power supply dimmable 350 mA 3,9 - 9 ,0 W	31,95 €





Quick-Terminal



through-wiring

DIONE

- aluminium
- dimensions H x Ø: 41 x 82 mm
- required ceiling cavity only 25 mm
- through-wiring possible
- quick installation through Quick-Terminal
- dimmable via phase cut-off

item	colour	colour temperature	light current	price
565355	<input type="checkbox"/> white	3000 K	700 lm	59,95 €
565356	<input type="checkbox"/> silver coloured	3000 K	700 lm	59,95 €
565357	<input type="checkbox"/> black	3000 K	700 lm	59,95 €
565358	<input type="checkbox"/> white	4000 K	750 lm	59,95 €
565359	<input type="checkbox"/> silver coloured	4000 K	750 lm	59,95 €
565360	<input type="checkbox"/> black	4000 K	750 lm	59,95 €

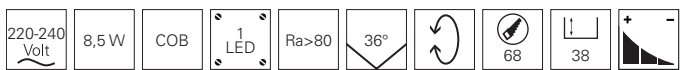

mounting from 25 mm ceiling cavity



ORIONIS

- aluminium diecast
- dimensions H x Ø: 72 x 78 mm
- dimmable via optional power supply

item	colour	colour temperature	light current	price
565237	□ white	ww 2700 K	645 lm	84,95 €
565240	■ black	ww 2700 K	645 lm	84,95 €

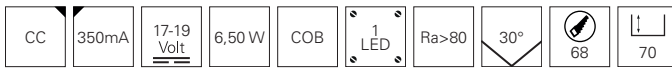

accessories

829063	safety spacer	6,95 €
180512	power supply 350 mA 0,7 - 18,0 W	26,95 €
862202	power supply dimmable 350 mA 3,9 - 9,0 W	31,95 €



ORIONIS

- aluminium diecast
- dimensions L x B x H: 78 x 78 x 72 mm
- dimmable via optional power supply

item	colour	colour temperature	light current	price
565241	□ white	ww 2700 K	645 lm	89,95 €
565244	■ black	ww 2700 K	645 lm	89,95 €



accessories

829063	safety spacer	6,95 €
180512	power supply 350 mA 0,7 - 18,0 W	26,95 €
862202	power supply dimmable 350 mA 3,9 - 9,0 W	31,95 €



COB 94 RGBW

- aluminium diecast
- dimensions H x Ø: 70 x 110 mm
- dimmable via optional controller

item	colour	colour temperature	light current	price
565245	<input type="checkbox"/> grey	3000 K	710 lm	129,95 €
565246	<input type="checkbox"/> silver coloured brushed	3000 K	710 lm	129,95 €

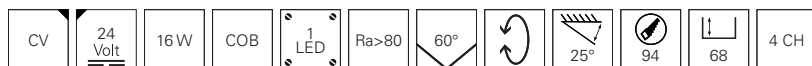

accessories

829063	safety spacer	6,95 €
862234	power supply 24V 20,0 W	26,95 €
862166	power supply 24V 100,0 W	104,95 €
843059	RF controller Set RGB+White 12/24/48V	119,95 €





COB-68-350MA-2700K-ROUND-FLAT

- aluminium
- dimensions H x Ø: 30 x 78 mm
- dimmable via optional power supply

item	colour	colour temperature	light current	price
565263	<input type="checkbox"/> white	2700 K	490 lm	49,95 €
565262	<input type="checkbox"/> silver coloured brushed	2700 K	490 lm	49,95 €
565265	<input type="checkbox"/> white	4000 K	540 lm	49,95 €
565264	<input type="checkbox"/> silver coloured brushed	4000 K	540 lm	49,95 €



accessories

829063	safety spacer	6,95 €
862212	power supply 350 mA 3,2-8,0 W	23,95 €
862202	power supply dimmable 350 mA 3,9-9,0 W	31,95 €



With the kind support of Göbel's Schlosshotel / 36289 Friedewald [bei Bad Hersfeld]



COB-68-350MA-2700K-ROUND

- aluminium
- dimensions H x Ø: 46 x 78 mm
- dimmable via optional power supply

item	colour	colour temperature	light current	price
565279	<input type="checkbox"/> white	ww 2700 K	580 lm	59,95 €
565278	<input type="checkbox"/> silver coloured brushed	ww 2700 K	580 lm	59,95 €
565281	<input type="checkbox"/> white	nw 4000 K	660 lm	59,95 €
565280	<input type="checkbox"/> silver coloured brushed	nw 4000 K	660 lm	59,95 €



accessories

829063	safety spacer	6,95 €
180512	power supply 350 mA 0,7-18,0 W	26,95 €
862202	power supply dimmable 350 mA 3,9-9,0 W	31,95 €



COB-68-350MA-2700K-ANGULAR

- aluminium
- dimensions L x B x H: 78 x 78 x 46 mm
- dimmable via optional power supply

item	colour	colour temperature	light current	price
565283	<input type="checkbox"/> white	ww 2700 K	580 lm	62,95 €
565282	<input type="checkbox"/> silver coloured brushed	ww 2700 K	580 lm	62,95 €
565285	<input type="checkbox"/> white	nw 4000 K	660 lm	62,95 €
565284	<input type="checkbox"/> silver coloured brushed	nw 4000 K	660 lm	62,95 €



accessories

829063	safety spacer	6,95 €
180512	power supply 350 mA 0,7-18,0 W	26,95 €
862202	power supply dimmable 350 mA 3,9-9,0 W	31,95 €



COB-68-24V-2700K-ROUND-FLAT

- aluminium diecast
- dimensions H x Ø: 36 x 85mm
- dimmable via optional power supply

item	colour	colour temperature	light current	price
565300	<input type="checkbox"/> white	ww 2700 K	330 lm	59,95 €
565299	<input type="checkbox"/> silver coloured brushed	ww 2700 K	330 lm	59,95 €
565302	<input type="checkbox"/> white	nw 4000 K	370 lm	59,95 €
565301	<input type="checkbox"/> silver coloured brushed	nw 4000 K	370 lm	59,95 €

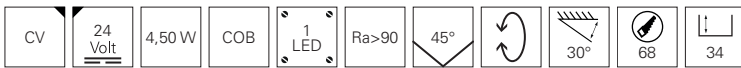

accessories

829063	safety spacer	6,95 €
872630	power supply 24V DC 6,0 W	18,95 €
862234	power supply 24V 20,0 W	26,95 €
862122	power supply 24V DC 50,0 W	59,95 €
843056	RF controller Set Single 12/24/48V	104,95 €



COB-68-24V-2700K-ROUND

- aluminium diecast
- dimensions H x Ø: 51,50 x 85,00 mm
- dimmable via optional power supply

item	colour	colour temperature	light current	price
565304	<input type="checkbox"/> white	ww 2700 K	630 lm	63,95 €
565303	<input type="checkbox"/> silver coloured brushed	ww 2700 K	630 lm	63,95 €
565306	<input type="checkbox"/> white	nw 4000 K	720 lm	63,95 €
565305	<input type="checkbox"/> silver coloured brushed	nw 4000 K	720 lm	63,95 €

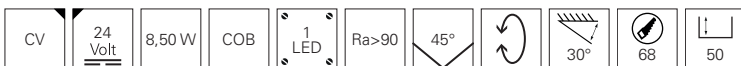

accessories

829063	safety spacer	6,95 €
862233	power supply 24V 12,0 W	22,95 €
862234	power supply 24V 20,0 W	26,95 €
862166	power supply 24V 100,0 W	104,95 €
843056	RF controller Set Single 12/24/48V	104,95 €



COB-95-24V-2700K-ROUND

- aluminium diecast
- dimensions H x Ø: 55 x 115 mm
- dimmable via optional power supply

item	colour	colour temperature	light current	price
565308	<input type="checkbox"/> white	ww 2700 K	900 lm	109,95 €
565307	<input type="checkbox"/> silver coloured brushed	ww 2700 K	900 lm	109,95 €
565310	<input type="checkbox"/> white	nw 4000 K	1000 lm	109,95 €
565309	<input type="checkbox"/> silver coloured brushed	nw 4000 K	1000 lm	109,95 €

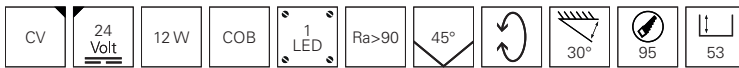

accessories

829063	safety spacer	6,95 €
862234	power supply 24V 20,0 W	26,95 €
862122	power supply 24V DC 50,0 W	59,95 €
862166	power supply 24V 100,0 W	104,95 €
843056	RF controller Set Single 12/24/48V	104,95 €



COB 68 RGBW

- aluminium
- dimensions H x Ø: 46 x 78 mm
- dimmable via optional controller

item	colour	colour temperature	light current	price
565335	<input type="checkbox"/> white	RGB ww	500 lm	109,95 €
565336	<input type="checkbox"/> silver coloured brushed	RGB ww	500 lm	109,95 €

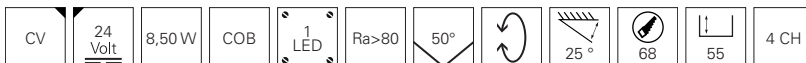

accessories

829063	safety spacer	6,95 €
862233	power supply 24V 12,0 W	22,95 €
862122	power supply 24V DC 50,0 W	59,95 €
843059	RF controller Set RGB+White 12/24/48V	119,95 €

SMD-68-230V-RUND

A lot of power for a small price! The recessed luminaires of the SMD-68 series provide up to 550 lm and also have an integrated, dimmable power supply unit [230V direct connection], which makes the use of GU10 sockets and retrofit upgrades unnecessary.



SMD-68-230V-ROUND

- plastic
- dimensions H x Ø: 44 x 85 mm
- dimmable via phase control or phase cut-off

item	colour	colour temperature	light current	price
565337	<input type="checkbox"/> white	2700 K	510 lm	22,95 €
565338	<input type="checkbox"/> white	3000 K	540 lm	22,95 €
565339	<input type="checkbox"/> white	4000 K	550 lm	22,95 €





COB 68 MOOD IP65

- aluminium
- dimensions H x Ø: 66 x 83 mm
- dim to warm

item	colour	colour temperature	light current	price
565192	<input type="checkbox"/> white	<input checked="" type="checkbox"/> 2000-2800 K	500 lm	74,95 €

220-240 Volt	7 W	1 LED	Ra>80	40°	68	65	dtw	IP65
--------------	-----	-------	-------	-----	----	----	-----	------

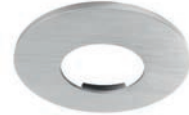

cover

930079	cover angular metal silver satined 83 x 83 x 4 mm	10,95 €
930075	cover angular metal white 83 x 83 x 4 mm	10,95 €
930077	cover angular metal chrome look 83 x 83 x 4 mm	10,95 €
930100	cover angular metal silver brushed 83 x 83 x 4 mm	10,95 €
930078	cover round metal silver satined 83 x 4 mm	10,95 €
930074	cover round metal white 83 x 4 mm	10,95 €
930076	cover round metal chrome look 83 x 4 mm	10,95 €
930099	cover round metal silver brushed 83 x 4 mm	10,95 €

COB BACK LIGHT

Designed as a recessed ceiling luminaire for indoor use, the COB BACK LIGHT is equally suitable for classic and modern interiors and architectural projects. The 9 Watt COB warm white LED with 48° beam angle sits in a white die-cast aluminium housing and creates additional, indirect light via the integrated reflector for even more atmosphere in the room.



COB BACK LIGHT

- aluminium diecast
- dimensions H x Ø: 89 x 110 mm
- dimmable via optional power supply

item	colour	colour temperature	light current	price
565224	white	3000K	1000 lm	104,95 €



accessories

180513	power supply 500 mA 1,0-18,0 W	26,95 €
862236	power supply dimmable 500 mA 6,0-12,0 W	32,95 €



LESATH

In various shapes and surface finishes, the LESATH swivel-mounted recessed ceiling luminaire can be used in a wide variety of applications - from retail and gastronomy to private living spaces. Additional flexibility for planners, architects and electricians is provided by the warm white light source that can vary its colour temperature [2000 – 2800 K] by dimming via phase control. The integrated power supply unit for the 7 Watt LED ensures easy installation.



LESATH

- aluminium diecast
- dimensions H x Ø: 60 x 85 mm
- dim to warm

item	colour	colour temperature	light current	price
565261	■ black	ww 2000-2800 K	500 lm	95,95 €

220-240 Volt	8,5 W	COB	1 LED	Ra>80	45°	15°	75	70	dtw
--------------	-------	-----	-------	-------	-----	-----	----	----	-----



cover

930252	frame round aluminium brushed 22 x 90 mm	9,95 €
930254	frame round aluminium chrome look 22 x 90 mm	9,95 €
930253	frame round aluminium white painted 22 x 90 mm	9,95 €
930255	frame angular aluminium brushed 90 x 90 x 22 mm	10,95 €
930257	frame angular aluminium chrome look 90 x 90 x 22 mm	10,95 €
930256	frame angular aluminium white painted 90 x 90 x 22 mm	10,95 €



COB 95

- aluminium
- dimensions H x Ø: 53 x 110 mm
- dimmable via optional power supply
- incl. 2 plastic panes [clear, satined]

item	colour	colour temperature	light current	price
565007	<input type="checkbox"/> white	3000 K	1100 lm	84,95 €
565010	<input type="checkbox"/> white	4000 K	1100 lm	84,95 €



accessories

180512	power supply 350 mA 2-52V 0,7-18,0 W	26,95 €
862204	power supply dimmable 350 mA 28-57V 9,8-20,0 W	44,95 €
862191	power supply MULTI-CC DALI1/2/Intelli-Push dimmable 20-60V 7,0-20,0 W	69,95 €



COB 130

- aluminium
- dimensions H x Ø: 69 x 145 mm
- dimmable via optional power supply
- incl. 2 plastic panes [clear, satined]

item	colour	colour temperature	light current	price
565180	<input type="checkbox"/> white	3000 K	1360 lm	99,95 €
565181	<input type="checkbox"/> white	4000 K	1450 lm	99,95 €



accessories

862132	power supply 500 mA 2-40V 1,0-20,0 W	31,95 €
862205	power supply dimmable 500 mA 20-40V 10,0-20,0 W	46,95 €
862191	power supply MULTI-CC DALI1/2/Intelli-Push dimmable 20-50V 10,0-25,0 W	69,95 €



COB 170

- aluminium
- dimensions H x Ø: 86 x 190 mm
- dimmable via optional power supply
- incl. 2 plastic panes [clear, satined]

item	colour	colour temperature	light current	price
565182	<input type="checkbox"/> white	3000 K	2100 lm	139,95 €
565183	<input type="checkbox"/> white	4000 K	2100 lm	139,95 €

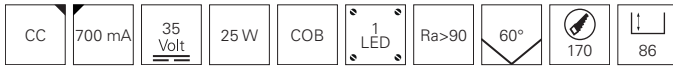

accessories

862198	power supply 700 mA 21-43V 14,7-30,0 W	31,95 €
862208	power supply dimmable 700 mA 28-56V 19,6-40,0 W	53,95 €
862192	power supply MULTI-CC DALI1/2/Intelli-Push dimmable 25-64V 17,5-45,0 W	74,95 €



COB 210

- aluminium
- dimensions H x Ø: 99 x 230 mm
- dimmable via optional power supply
- incl. 2 plastic panes [clear, satined]

item	colour	colour temperature	light current	price
565184	<input type="checkbox"/> white	3000 K	3000 lm	179,95 €
565185	<input type="checkbox"/> white	4000 K	3200 lm	179,95 €



accessories

862201	power supply 1050 mA 19-38V 20,0-40,0 W	33,95 €
862209	power supply dimmable 1050 mA 19-38V 20,0-40,0 W	53,95 €
862193	power supply MULTI-CC DALI1/2/Intelli-Push dimmable 14-43V 14,7-45,0 W	74,95 €



ALYA

- LED-power supply integrated in the housing
- plastic
- dimmable via phase control or phase cut-off

item	colour	colour temperature	light current	power	dimensions H x Ø / L x B x H	cutout Ø / L x B	price
565320	<input type="checkbox"/> white	2700 K	540 lm	7,50 W	10 x 120 mm	100 mm	23,95 €
565367	<input type="checkbox"/> white	3000 K	555 lm	7,50 W	10 x 120 mm	100 mm	23,95 €
565321	<input type="checkbox"/> white	2700 K	540 lm	7,50 W	120 x 120 x 10 mm	105 x 105 mm	26,95 €
565368	<input type="checkbox"/> white	3000 K	555 lm	7,50 W	120 x 120 x 10 mm	105 x 105 mm	26,95 €
565322	<input type="checkbox"/> white	2700 K	960 lm	11,50 W	10 x 180 mm	150 mm	31,95 €
565369	<input type="checkbox"/> white	3000 K	990 lm	11,50 W	10 x 180 mm	150 mm	31,95 €
565323	<input type="checkbox"/> white	2700 K	960 lm	11,50 W	180 x 180 x 10 mm	155 x 155 mm	33,95 €
565370	<input type="checkbox"/> white	3000 K	990 lm	11,50 W	180 x 180 x 10 mm	155 x 155 mm	33,95 €

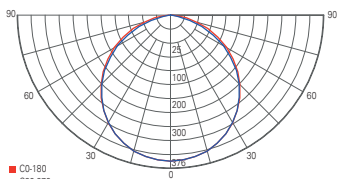

light distribution curve 565320, 565367

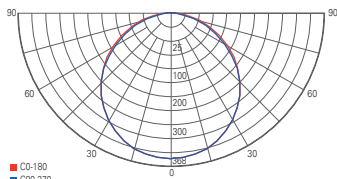

light distribution curve 565322, 565369

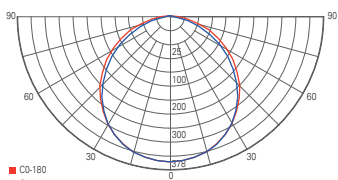

light distribution curve 565321, 565368

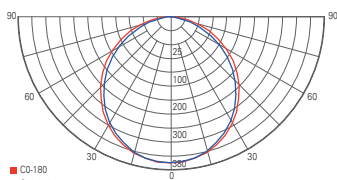

light distribution curve 565323, 565370



LED PANEL SQUARE 8 + 15 + 20

- aluminium diecast
- dimensions L x B x H: 237 x 237 x 20 mm
- dimmable via optional power supply

item	colour	colour temp.	light current	dimensions L x B x H	Strom/voltage	power	cutout L x B	price
565152	<input type="checkbox"/> white	2700 K	560 lm	110 x 110 x 23,5 mm	350 mA/18-19 V	7 W	90 x 90 mm	38,95 €
565153	<input type="checkbox"/> grey	2700 K	560 lm	110 x 110 x 23,5 mm	350 mA/18-19 V	7 W	90 x 90 mm	38,95 €
565154	<input type="checkbox"/> white	4000 K	560 lm	110 x 110 x 23,5 mm	350 mA/18-19 V	7 W	90 x 90 mm	38,95 €
565155	<input type="checkbox"/> grey	4000 K	560 lm	110 x 110 x 23,5 mm	350 mA/18-19 V	7 W	90 x 90 mm	38,95 €
565156	<input type="checkbox"/> white	2700 K	1000 lm	180 x 180 x 21,0 mm	350 mA/36-37 V	13 W	115 x 115 mm	57,95 €
565157	<input type="checkbox"/> grey	2700 K	1000 lm	180 x 180 x 21,0 mm	350 mA/36-37 V	13 W	115 x 115 mm	57,95 €
565158	<input type="checkbox"/> white	4000 K	1130 lm	180 x 180 x 21,0 mm	350 mA/36-37 V	13 W	115 x 115 mm	57,95 €
565159	<input type="checkbox"/> grey	4000 K	1130 lm	180 x 180 x 21,0 mm	350 mA/36-37 V	13 W	115 x 115 mm	57,95 €
565160	<input type="checkbox"/> white	2700 K	1560 lm	237 x 237 x 20 mm	700 mA/23-24 V	17 W	215 x 215 mm	79,95 €
565161	<input type="checkbox"/> grey	2700 K	1560 lm	237 x 237 x 20 mm	700 mA/23-24 V	17 W	215 x 215 mm	79,95 €
565162	<input type="checkbox"/> white	4000 K	1740 lm	237 x 237 x 20 mm	700 mA/23-24 V	17 W	215 x 215 mm	79,95 €
565163	<input type="checkbox"/> grey	4000 K	1740 lm	237 x 237 x 20 mm	700 mA/23-24 V	17 W	215 x 215 mm	79,95 €

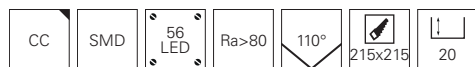

accessories for **565152, 565153, 565154, 565155**

862223	power supply 350 mA 2-35V 0,7-12,0 W	25,95 €
862202	power supply dimmable 350 mA 11-26V 3,9-9,0 W	31,95 €
862190	power supply MULTI-CC DALI1/2/Intelli-Push dimmable 15-34V 4,2-12,0 W	64,95 €

accessories for **565156, 565157, 565158, 565159**

180512	power supply 350 mA 2-52V 0,7-18,0 W	26,95 €
862204	power supply dimmable 350 mA 28-57V 9,8-20,0 W	44,95 €
862191	power supply MULTI-CC DALI1/2/Intelli-Push dimmable 20-60V / 7,0-20,0 W	69,95 €

accessories for **565160, 565161, 565162, 565163**

180514	power supply 700 mA 2-26V 1,4-18,0 W	26,95 €
862207	power supply dimmable 700 mA 14-28V 9,8-20,0 W	46,95 €
862191	power supply MULTI-CC DALI1/2/Intelli-Push dimmable 20-36V 14,0-25,0 W	69,95 €



UNI II

- aluminium diecast
- dimensions H x Ø: 84 x 139 mm
- dimmable via optional power supply

item	colour	colour temperature	light current	price
565343	white	3000 K	1035 lm	119,95 €
565361	black	3000 K	1035 lm	119,95 €



accessories

930339	reflector ring black	11,95 €
930340	reflector ring gold	11,95 €
930341	reflector ring chrome	11,95 €
930371	reflector ring II black	10,95 €
930337	cover heatsink black	3,55 €
930306	reflector 50°	10,95 €
930307	honeycomb filter	10,95 €
930308	spread lens 40° clear/satined	10,95 €
930309	softening lens 47° satined	10,95 €
930310	linear spread lens 40°/80° asymmetric clear/satined	10,95 €
180512	power supply 350 mA 2-52V 0,7-18,0 W	26,95 €
862204	power supply dimmable 350 mA 28-57V 9,8-20,0 W	44,95 €
862191	power supply MULTI-CC DALI DALI1/2/Intelli-Push dimmable 20-60V 7,0-20,0 W	69,95 €



UNI II MINI

- aluminium diecast
- dimensions H x Ø: 80 x 103 mm
- dimmable via optional power supply

item	colour	colour temperature	light current	price
565342	white	3000 K	670 lm	99,95 €
565354	black	3000 K	670 lm	99,95 €



accessories

930331	reflector ring black	10,95 €
930332	reflector ring gold	10,95 €
930333	reflector ring chrome	10,95 €
930381	reflector ring II black	10,95 €
930329	cover heatsink black	3,55 €
180513	power supply 500 mA 2-38V 1,0-18,0 W	26,95 €
862236	power supply dimmable 500 mA 12-24V 6,0-12,0 W	32,95 €
862190	power supply MULTI-CC DALI1/2/Intelli-Push dimmable 15-24V 7,5-12,0 W	64,95 €



UNI II MAX

- aluminium diecast
- dimensions H x Ø: 97 x 165 mm
- dimmable via optional power supply

item	colour	colour temperature	light current	price
565344	white	3000 K	2150 lm	149,95 €
565351	black	3000 K	2150 lm	149,95 €

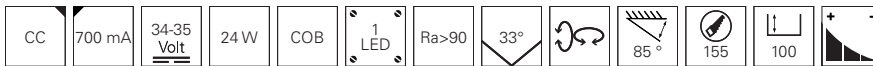

accessories

930398	reflector ring black	12,95 €
930399	reflector ring gold	14,95 €
930382	reflector ring II black	10,95 €
930396	cover heatsink black	10,95 €
930390	reflector 24°	12,95 €
930392	reflector 50°	12,95 €
862198	power supply 700 mA 21-43V 14,7-30,0 W	31,95 €
862208	power supply dimmable 700 mA 28-56V 19,6-40,0 W	53,95 €
862192	power supply MULTI-CC DALI1/2/Intelli-Push dimmable 25-64V 17,5-45,0 W	74,95 €

MODULAR SYSTEM COB

The MODULAR family of recessed ceiling luminaires offers a wide range of applications. Whether almost invisible or with a present frame – these modules are as flexible as you want them to be. By exchanging the reflectors, different light cones can be created and by using filters / diffusers, you can individually select or retrofit your lighting mood. We offer the LED modules in warm and neutral white. This gives you the option of adapting the individual elements to local requirements in order to create your perfect lighting situation.



MODULAR SYSTEM COB 31W

- aluminium diecast
- dimensions H x Ø: 116 x 93 mm
- dimmable via optional power supply



item	colour	colour temperature	light current	price
565352	■ black	■ ww 3000 K	3270 lm	109,95 €
565353	■ black	■ nw 4000 K	3350 lm	109,95 €

CC	900 mA	35-36 Volt	31 W	COB	1 LED	Ra>90	60°
----	--------	------------	------	-----	-------	-------	-----

accessories

930084	reflector 17°	10,95 €
930085	reflector 40°	10,95 €
930087	diffusor gefrostet	1,25 €
930088	honeycomb filter	5,95 €
862157	power supply basic 900 mA 22-44V 19,8-40,0 W	33,95 €
862192	power supply MULTI-CC DALI1/2/Intelli-Push dimmable 25-50V 22,5-45,0 W	74,95 €

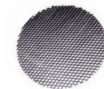



accessories **built-in ring fixed**

- 930089** white | H x Ø: 50 x 170 mm | cut-out size Ø: 150 mm
- 930090** white | H x Ø: 80 x 230 mm | cut-out size Ø: 220 mm

22,95 €

29,95 €



accessories **built-in ring transversable**

- 930091** white | H x Ø: 30 x 130 mm | cut-out size: 115 mm

32,95 €



accessories **gimbal frame transversable**

- 930092** 1er gimbal frame | white | L x B x H: 140 x 140 x 43 mm | cut-out size: 130 x 130 mm
- 930093** 2er gimbal frame | white | L x B x H: 257 x 140 x 43 mm | cut-out size: 240 x 130 mm

36,95 €

66,95 €



accessories **gimbal frame transversable | without frame**

- 930094** 1er gimbal frame | white | L x B x H: 178 x 120 x 50 mm | cut-out size: 120 x 120 mm
- 930095** 1er gimbal frame | black | L x B x H: 178 x 120 x 50 mm | cut-out size: 120 x 120 mm
- 930096** 2er gimbal frame | white | L x B x H: 305 x 120 x 50 mm | cut-out size: 247 x 120 mm
- 930097** 2er gimbal frame | black | L x B x H: 305 x 120 x 50 mm | cut-out size: 247 x 120 mm

89,95 €

89,95 €

115,95 €

115,95 €



CETI 5

- aluminium diecast
- dimensions L x B x H: 137 x 52 x 44 mm
- dimmable via optional power supply

item	colour	colour temperature	light current	price
565250	white, black	3000 K	800 lm	109,95 €

CC	700 mA	14-15 Volt	10 W	SMD	5 LED	Ra>90	45°	130x36	50
----	--------	------------	------	-----	-------	-------	-----	--------	----

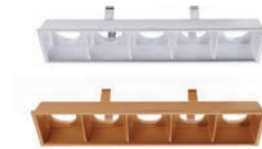

accessories

930218	reflector silver coloured	14,95 €
930215	reflector gold optics	14,95 €
862049	power supply 700 mA 2-19V 1,4-12,0 W	25,95 €
862237	power supply dimmable 700 mA 10-17V 7,0-12,0 W	32,95 €

CETI 10

- aluminium diecast
- dimensions L x B x H: 257 x 52 x 44 mm
- dimmable via optional power supply



item	colour	colour temperature	light current	price
565251	white, black	3000 K	1600 lm	179,95 €

CC	700 mA	28-29 Volt	20 W	SMD	10 LED	Ra>90	45°	250x36	50
----	--------	------------	------	-----	--------	-------	-----	--------	----



accessories

930219	reflector silver coloured	19,95 €
930216	reflector gold optics	19,95 €
862198	power supply 700 mA 13-43V 14,7-30,0 W	31,95 €
862207	power supply dimmable 700 mA 14,0-28,0V 9,8-20,0 W	46,95 €
862191	power supply MULTI-CC DALI DALI1/2/Intelli-Push dimmable 20-36V 5,0-25,0 W	69,95 €



CETI 15

- aluminium diecast
- dimensions L x B x H: 376 x 52 x 44 mm
- dimmable via optional power supply

item	colour	colour temperature	light current	price
565252	white, black	3000 K	2400 lm	249,95 €

CC	700 mA	44-45 Volt	30 W	SMD	15 LED	Ra>90	45°	369x36	50
----	--------	------------	------	-----	--------	-------	-----	--------	----

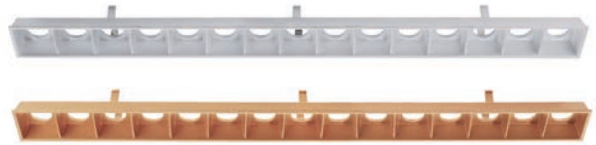

accessories

930220	reflector silver coloured	24,95 €
930217	reflector gold optics	24,95 €
862199	power supply 700 mA 20-57V 20,3-40,0 W	33,95 €
862208	power supply dimmable 700 mA 28-56V 19,6-40,0 W	53,95 €
862192	power supply MULTI-CC DALI1/2/Intelli-Push dimmable 25-64V 17,5-45,0W	74,95 €





CETI 5 HIDE

- aluminium diecast
- dimensions L x B x H: 131 x 56 x 110 mm
- dimmable via optional power supply

item	colour	colour temperature	light current	price
565253	■ black	ww 3000 K	800 lm	129,95 €

CC	700 mA	14-15 Volt	10 W	SMD	5 LED	Ra>90	45°	135x58	50
----	--------	------------	------	-----	-------	-------	-----	--------	----

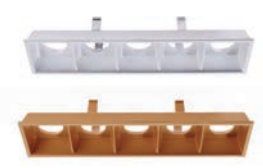

accessories

930218	reflector silver coloured	14,95 €
930215	reflector gold optics	14,95 €
862049	power supply 700 mA 2-19V 1,4-12,0 W	25,95 €
862237	power supply dimmable 700 mA 10-17V 7,0-12,0 W	32,95 €



CETI 10 HIDE

- aluminium diecast
- dimensions L x B x H: 251 x 56 x 110 mm
- dimmable via optional power supply

item	colour	colour temperature	light current	price
565254	■ black	ww 3000 K	1600 lm	199,95 €

CC	700 mA	28-29 Volt	20 W	SMD	10 LED	Ra>90	45°	255x58	50
----	--------	------------	------	-----	--------	-------	-----	--------	----



accessories

930219	reflector silver coloured	19,95 €
930216	reflector gold optics	19,95 €
862198	power supply 700 mA 13-43V 14,7-30,0 W	31,95 €
862207	power supply dimmable 700 mA 14,0-28,0V 9,8-20,0 W	46,95 €
862191	power supply MULTI-CC DALI DALI1/2/Intelli-Push dimmable 20-36V 5,0-25,0 W	69,95 €



CETI 15 HIDE

- aluminium diecast
- dimensions L x B x H: 370 x 56 x 110 mm
- dimmable via optional power supply

item	colour	colour temperature	light current	price
565255	black	3000 K	2400 lm	259,95 €

CC	700 mA	44-45 Volt	30 W	SMD	15 LED	Ra>90	45°	375x58	50
----	--------	------------	------	-----	--------	-------	-----	--------	----



accessories

930220	reflector silver coloured	24,95 €
930217	reflector gold optics	24,95 €
862199	power supply 700 mA 20-57V 20,3-40,0 W	33,95 €
862208	power supply dimmable 700 mA 28-56V 19,6-40,0 W	53,95 €
862192	power supply MULTI-CC DALI1/2/Intelli-Push dimmable 25-64V 17,5-45,0W	74,95 €





CETI 5 ADJUST

- aluminium diecast
- dimensions L x B x H: 155 x 77 x 83 mm
- dimmable via optional power supply

item	colour	colour temperature	light current	price
565256	white, black	3000 K	800 lm	129,95 €

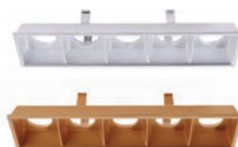

accessories

930218	reflector silver coloured	14,95 €
930215	reflector gold optics	14,95 €
862049	power supply 700 mA 2-19V 1,4-12,0 W	25,95 €
862237	power supply dimmable 700 mA 10-17V 7,0-12,0 W	32,95 €



CETI 10 ADJUST

- aluminium diecast
- dimensions L x B x H: 275 x 83 x 77 mm
- dimmable via optional power supply

item	colour	colour temperature	light current	price
565257	white, black	3000 K	1600 lm	219,95 €



accessories

930219	reflector silver coloured	19,95 €
930216	reflector gold optics	19,95 €
862198	power supply 700 mA 13-43V 14,7-30,0 W	31,95 €
862207	power supply dimmable 700 mA 14,0-28,0V 9,8-20,0 W	46,95 €
862191	power supply MULTI-CC DALI DALI1/2/Intelli-Push dimmable 20-36V 5,0-25,0 W	69,95 €



CETI 15 ADJUST

- aluminium diecast
- dimensions L x B x H: 394 x 77 x 83 mm
- dimmable via optional power supply

item	colour	colour temperature	light current	price
565258	white, black	3000 K	2400 lm	289,95 €



accessories

930220	reflector silver coloured	24,95 €
930217	reflector gold optics	24,95 €
862199	power supply 700 mA 20-57V 20,3-40,0 W	33,95 €
862208	power supply dimmable 700 mA 28-56V 19,6-40,0 W	53,95 €
862192	power supply MULTI-CC DALI1/2/Intelli-Push dimmable 25-64V 17,5-45,0W	74,95 €





3K SMALL
page 153

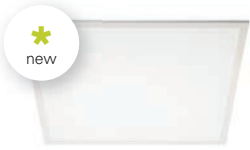

BASIC
from page 156



BASIC FLEX
from page 157



BASIC OFFICE
from page 158



PRO OFFICE
from page 159

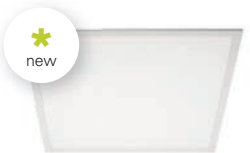

STANDARD FLEX
from page 162



STANDARD OFFICE
from page 163



STANDARD OFFICE FLEX
from page 164



STANDARD HCL
page 166



STANDARD RGBW
page 167

insert panels





With the kind support of Regionaldirektion für Deutsche Vermögensberatung Pierre Werner / Direktion für Deutsche Vermögensberatung Uwe Liebholz



LED PANEL 3K SMALL

In the ceiling or on the ceiling – the LED PANEL 3K SMALL is convincing in every variant. In addition to the optionally available frames for the ceiling insert or the ceiling installation, the compact LED panel [available in 3000 or 4000K] can be dimmed via a separate power supply in a flexible control mode. In this way the LED PANEL 3K SMALL presents itself as a modern ceiling luminaire for offices, public authorities, restaurants and much more.



LED PANEL 3K SMALL

- aluminium
- dimensions L x B x H: 295 x 295 x 10 mm
- dimmable via optional power supply
- incl. 50 cm connection cable

item	colour	colour temperature	light current	price
565220	<input type="checkbox"/> white	 3000 K	2500 lm	75,95 €
565221	<input type="checkbox"/> white	 4000 K	2500 lm	75,95 €



accessories

930230	insert frame 30 x 30	29,95 €
930167	surface mounting frame 30 x 30	29,95 €
862198	power supply 700 mA 21-43V 14,7-30,0 W	31,95 €
862208	power supply dimmable 700 mA 28-56V 19,6-40,0 W	53,95 €
862192	power supply MULTI-CC DALI1/2/Intelli-Push dimmable 25-64V 17,5-45,0 W	74,95 €

BACKLIGHT PANELS [SERIES: BASIC AND PRO] – TECHNOLOGY AND ADVANTAGES

Not every LED panel is built the same! There are technologies exist to produce homogeneous, flat and glare-free light. Each method has its own advantages and disadvantages and depends on the individual user requirements and budget needs. For example, the LED panels from our BASIC and PRO series rely on backlight technology.

In LED panels with backlight technology, the LEDs - behind the diffuser - are evenly spread over the entire panel surface and shine directly downwards. This design has a decisive advantage: no other components are required to direct the light in the desired direction [downwards], because the LEDs are already in the »right« position. The simpler design results above all in better efficiency and a lower price as well as a longer lifetime. At the same time you do not have to worry about possible yellowing of the light guide plate, which is often used in some cheaper sidelight panels.

The disadvantages: Due to their design, the LED elements require more space, which is why backlight panels are curved towards the backside and therefore have a higher thickness with it. For this [optical] reason, backlight panels are only suitable to a limited extent for suspension from the ceiling. Their smaller beam angle [approx. 90°] results in a smaller illuminated area.

advantages

- better efficiency
- longer lifetime
- lower costs
- much more attractive price/performance ratio
- no light guide plates that are prone to yellowing

disadvantages

- higher thickness
- lower beam angle [approx. 90°]
- less suitable for suspension
- thicker packaging

In the following picture you can see the typical structure of a backlight LED panel.



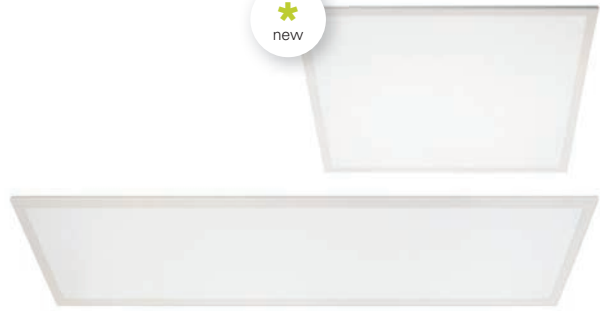

LED PANEL BASIC

- aluminium
- UGR<22
- incl. power supply CC, 900mAh, 33-38V, 36W

item	colour	colour temperature	light current	dimensions L x B x H	price
100149	<input type="checkbox"/> white	3000 K	3880 lm	595 x 595 x 32 mm	74,95 €
100150	<input type="checkbox"/> white	4000 K	4320 lm	595 x 595 x 32 mm	74,95 €
100140	<input type="checkbox"/> white	3000 K	3900 lm	620 x 620 x 32 mm	79,95 €
100141	<input type="checkbox"/> white	4000 K	4320 lm	620 x 620 x 32 mm	79,95 €
100143	<input type="checkbox"/> white	3000 K	3880 lm	1195 x 295 x 32 mm	84,95 €
100144	<input type="checkbox"/> white	4000 K	4320 lm	1195 x 295 x 32 mm	84,95 €



accessories

930674	safety rope	4,95 €
930676	installation brackets	4,95 €
optional power supplies CC, 900mAh, 33-38V, 36W		
862192	power supply MULTI-CC DALI1/2/Intelli-Push dimmable 25-64V 17,5-45,0 W	74,95 €
862175	power supply Meanwell KNX dimmable 2-100V 42,0 W	144,95 €
862244	power supply Meanwell mit Casambi-App dimmable 2-100V 42,0 W	249,95 €

accessories for **100149, 100150**

930664	surface mounting frame 60 x 60 x 7 cm	54,95 €
930667	mounting frame 60 x 60 cm	52,95 €

accessories for **100140, 100141**

930665	surface mounting frame 62,5 x 62,5 x 7 cm	59,95 €
930668	mounting frame 62,5 x 62,5 cm	57,95 €

accessories for **100143, 100144**

930666	surface mounting frame 120 x 30 x 7 cm	69,95 €
930669	mounting frame 120 x 30 cm	67,95 €



dip switch

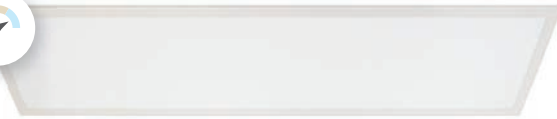
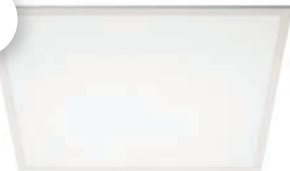

LED PANEL BASIC FLEX

- aluminium
- UGR<22
- incl. power supply CC, 900mAh, 33-38V, 36W
- light colour adjustable via dip switch

item	colour	colour temperature	light current	dimensions L x B x H	price
100142	<input type="checkbox"/> white	ww nw cw 3000/4000/6000 K	3900/4320/4140 lm	620 x 620 x 32 mm	99,95 €
100145	<input type="checkbox"/> white	ww nw cw 3000/4000/6000 K	3900/4320/4140 lm	1195 x 295 x 32 mm	104,95 €



accessories

930674	safety rope	4,95 €
930676	installation brackets	4,95 €
optional power supplies CC, 900mAh, 33-38V, 36W		
862192	power supply MULTI-CC DALI1/2/Intelli-Push dimmable 25-64V 17,5-45,0 W	74,95 €
862175	power supply Meanwell KNX dimmable 2-100V 42,0 W	144,95 €
862244	power supply Meanwell mit Casambi-App dimmable 2-100V 42,0 W	249,95 €

accessories for **100142**

930665	surface mounting frame 62,5 x 62,5 x 7 cm	59,95 €
930668	mounting frame 62,5 x 62,5 cm	57,95 €

accessories for **100145**

930666	surface mounting frame 120 x 30 x 7 cm	69,95 €
930669	mounting frame 120 x 30 cm	67,95 €

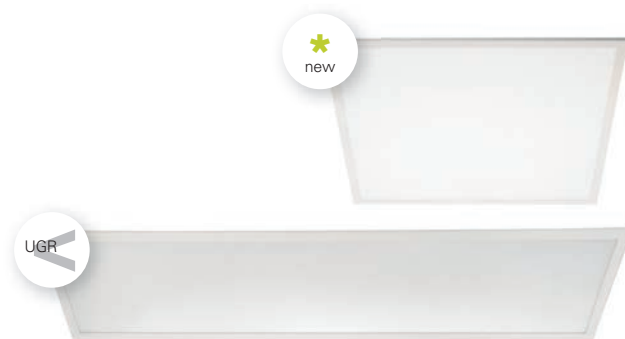

LED PANEL BASIC OFFICE

- aluminium
- UGR <19
- suitable for VDU workstations according to EN 12464-1 BAP65 ($L65 \leq 3000 \text{cd/m}^2$)
- microprismatic surface structure
- incl. power supply CC, 900mAh, 33-38V, 36W

item	colour	colour temperature	light current	dimensions L x B x H	price
100151	<input type="checkbox"/> white	4000 K	4000 lm	595 x 595 x 32 mm	84,95 €
100146	<input type="checkbox"/> white	4000 K	4000 lm	620 x 620 x 32 mm	89,95 €
100147	<input type="checkbox"/> white	4000 K	4000 lm	1195 x 295 x 32 mm	94,95 €



accessories

930674	safety rope	4,95 €
930676	installation brackets	4,95 €
optional power supplies CC, 900mAh, 33-38V, 36W		
862192	power supply MULTI-CC DALI1/2/Intelli-Push dimmable 25-64V 17,5-45,0 W	74,95 €
862175	power supply Meanwell KNX dimmable 2-100V 42,0 W	144,95 €
862244	power supply Meanwell mit Casambi-App dimmable 2-100V 42,0 W	249,95 €

accessories for **100151**

930664	surface mounting frame 60 x 60 x 7 cm	54,95 €
930667	mounting frame 60 x 60 cm	52,95 €

accessories for **100146**

930665	surface mounting frame 62,5 x 62,5 x 7 cm	59,95 €
930668	mounting frame 62,5 x 62,5 cm	57,95 €

accessories for **100147**

930666	surface mounting frame 120 x 30 x 7 cm	69,95 €
930669	mounting frame 120 x 30 cm	67,95 €

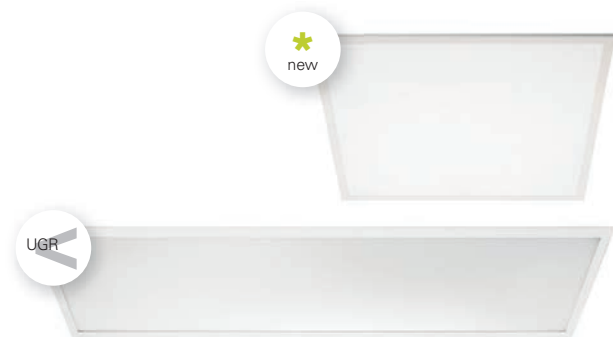

LED PANEL PRO OFFICE

- aluminium
- UGR <19
- suitable for VDU workstation according to EN 12464-1 BAP65 ($L65 \leq 3000\text{cd/m}^2$)
- microprismatic surface structure
- besonders energieeffizient

item	colour	colour temperature	light current	dimensions L x B x H	price
100148	<input type="checkbox"/> white	4000 K	3200 lm	595 x 595 x 32 mm	104,95 €
100084	<input type="checkbox"/> white	3000 K	2880 lm	620 x 620 x 32 mm	109,95 €
100088	<input type="checkbox"/> white	4000 K	3200 lm	620 x 620 x 32 mm	109,95 €
100089	<input type="checkbox"/> white	3000 K	2880 lm	1195 x 295 x 32 mm	114,95 €
100122	<input type="checkbox"/> white	4000 K	3200 lm	1195 x 295 x 32 mm	114,95 €

CC	450 mA	35-40 Volt	20 W	LED	Ra>80	90°	IP40
----	--------	------------	------	-----	-------	-----	------

accessories

930674	safety rope	4,95 €
930676	installation brackets	4,95 €
862257	power supply QUICK dimmable 450mAh 22-44V 9,9-20,0 W quick installation through Quick-Terminal und through-wiring	36,95 €
862191	power supply MULTI-CC DALI1/2/Intelli-Push dimmable 20-60V 5,0-25,0 W	69,95 €

accessories for **100148**

930664	surface mounting frame 60 x 60 x 7 cm	54,95 €
930667	mounting frame 60 x 60 cm	52,95 €

accessories for **100084, 100088**

930665	surface mounting frame 62,5 x 62,5 x 7 cm	59,95 €
930668	mounting frame 62,5 x 62,5 cm	57,95 €

accessories for **100089, 100122**

930666	surface mounting frame 120 x 30 x 7 cm	69,95 €
930669	mounting frame 120 x 30 cm	67,95 €

SIDELIGHT-PANELS [SERIES: STANDARD] – TECHNOLOGY AND ADVANTAGES

Not every LED panel is built the same! There are technologies exist to produce homogeneous, flat light. Each method has its own advantages and disadvantages and depends on the individual user requirements and budget needs. For example LED panels from our standard series use sidelight technology.

Unlike backlight panels, the LEDs are not spread over the entire panel surface, but are located on the side of the aluminum frame of the luminaire. Depending on the model and version, only one, two or all four sides are equipped with LED stripes. What all edgelit or sidelight panels have in common is that the LEDs shine into the center of the panel. The light must therefore still be redirected in order to radiate downwards.

The most important element here is the light guide plate. This is usually made of acrylic glass [also PMMA (poly-methyl methacrylate), a transparent thermoplastic material], which distributes the light evenly over the entire surface and deflects it downwards. In addition, acrylic glass does not yellow with age. In addition to the light guide plate, which deflects the light by means of small laser-engraved dots, the additional reflector, similar to the one the backlight panel, and the diffuser also contribute to the significantly more complex structure of a sidelight panel [see picture to the right].

The great advantage is the lower construction thickness, which is why edgelit panels can be integrated more discreetly in rooms and are better suited as pendant variants. At the same time, the panels allow a higher beam angle [approx. 120°] what results in a larger illuminated area. The disadvantages: Edgelit panels are more expensive and offer less efficiency and lifetime compared to backlight panels.

advantages

- lower thickness
- higher beam angle [approx. 120°]
- more suitable for suspension
- thinner packing

disadvantages

- higher costs
- worse price/performance ratio
- average lifetime
- lower efficiency

In the following picture you can see the typical structure of a sidelight LED panel.



aluminium frame with LEDs

microprismatic diffusing lens

diffuser disc

light guide panel

reflector insert

EVA [ethylene vinyl acetate copolymer] foam

back panel



dip switch



LED PANEL STANDARD FLEX

- aluminium
- UGR<22
- light colour adjustable via dip switch

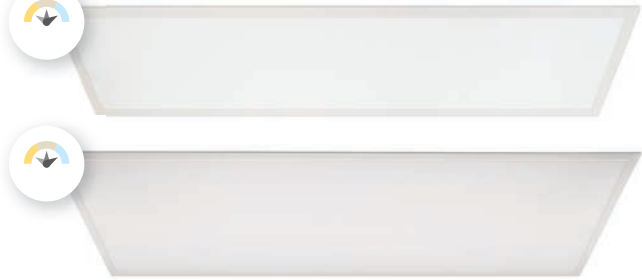

item	colour	colour temperature	light current	dimensions L x B x H	Strom	power	price
100123	<input type="checkbox"/> white	3000/4000/6000 K	3780/4200/4000 lm	620 x 620 x 9 mm	1050 mA	42 W	119,95 €
100125	<input type="checkbox"/> white	3000/4000/6000 K	3570/3990/3780 lm	1195 x 295 x 9 mm	1050 mA	42 W	124,95 €
100139	<input type="checkbox"/> white	3000/4000/6000 K	5300/6000/5700 lm	1195 x 595 x 9 mm	1500 mA	60 W	219,95 €



accessories

930674 safety rope **4,95 €**

accessories for **100123**

930672 wire suspension | 200 cm **22,95 €**

930665 surface mounting frame | 62,5 x 62,5 x 7 cm **59,95 €**

930670 mounting frame | 62,5 x 62,5 cm **59,95 €**

862258 power supply QUICK dimmable | 1050mAh | 22-43V | 23,1-45,0 W
quick installation through Quick-Terminal und through-wiring **46,95 €**

862193 power supply MULTI-CC DALI1/2/Intelli-Push dimmable | 14-43V | 14,7-45,0 W **74,95 €**

accessories for **100125**

930672 wire suspension | 200 cm **19,95 €**

930666 surface mounting frame | 120 x 30 x 7 cm **69,95 €**

930671 mounting frame | 120 x 30 cm **69,95 €**

862258 power supply QUICK dimmable | 1050mAh | 22-43V | 23,1-45,0 W
quick installation through Quick-Terminal und through-wiring **46,95 €**

862193 power supply MULTI-CC DALI1/2/Intelli-Push dimmable | 14-43V | 14,7-45,0 W **74,95 €**

accessories for **100139**

930673 wire suspension | 200 cm **32,95 €**

930675 surface mounting frame | 120 x 60 x 7 cm **69,95 €**

930688 mounting frame | 120 x 60 cm **84,95 €**

862259 power supply QUICK dimmable | 1500mAh | 20-40V | 30,0-60,0 W
quick installation through Quick-Terminal und through-wiring **56,95 €**

862194 power supply MULTI-CC DALI1/2/Intelli-Push dimmable | 25-70V | 26,3-75,0 W **91,95 €**



LED PANEL STANDARD OFFICE

- aluminium
- UGR <19
- suitable for VDU workstations according to EN 12464-1 BAP65 ($L65 \leq 3000\text{cd/m}^2$)
- microprismatic surface structure

item	colour	colour temperature	light current	dimensions L x B x H	price
100124	<input type="checkbox"/> white	<input checked="" type="checkbox"/> 4000 K	4200 lm	620 x 620 x 9 mm	124,95 €
100138	<input type="checkbox"/> white	<input checked="" type="checkbox"/> 4000 K	4200 lm	1195 x 295 x 9 mm	129,95 €

CC	1050 mA	33-38 Volt	42 W	LED	Ra>90	120°	IP40
----	---------	------------	------	-----	-------	------	------

accessories

930674	safety rope	4,95 €
930672	wire suspension 200 cm	22,95 €
862258	power supply QUICK dimmable 1050mAh 22-43V 23,1-45,0 W quick installation through Quick-Terminal und through-wiring	46,95 €
862193	power supply MULTI-CC DALI1/2/Intelli-Push dimmable 14-43V 14,7-45,0 W	74,95 €

accessories for **100124**

930665	surface mounting frame 62,5 x 62,5 x 7 cm	59,95 €
930670	mounting frame 62,5 x 62,5 cm	59,95 €

accessories for **100138**

930666	surface mounting frame 120 x 30 x 7 cm	69,95 €
930671	mounting frame 120 x 30 cm	69,95 €



dip switch



LED PANEL STANDARD OFFICE FLEX

- aluminium
- UGR <19
- suitable for VDU workstations according to EN 12464-1 BAP65 ($L65 \leq 3000 \text{cd/m}^2$)
- microprismatic surface structure
- light colour adjustable via dip switch
- incl. power supply CC, 1050mAh, 40W
- dimmable via phase control or phase cut-off

item	colour	colour temperature	light current	dimensions L x B x H	price
100078	<input type="checkbox"/> white	<input type="checkbox"/> ww <input type="checkbox"/> nw <input type="checkbox"/> cw 3000/4000/6000 K	3300 lm	620 x 620 x 10 mm	179,95 €
100079	<input type="checkbox"/> white	<input type="checkbox"/> ww <input type="checkbox"/> nw <input type="checkbox"/> cw 3000/4000/6000 K	3500 lm	1195 x 295 x 10 mm	209,95 €

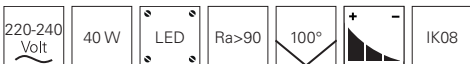

accessories for **100078**

930665	surface mounting frame 62,5 x 62,5 x 7 cm	59,95 €
930670	mounting frame 62,5 x 62,5 cm	59,95 €
optional power supplies CC, 1050mAh, 40W		
862193	power supply MULTI-CC DALI1/2/Intelli-Push dimmable 14-43V 14,7-45,0 W	74,95 €
862175	power supply Meanwell KNX dimmable 2-100V 42,0 W	144,95 €
862244	power supply Meanwell mit Casambi-App dimmable 2-100V 42,0 W	249,95 €

accessories for **100079**

930666	surface mounting frame 120 x 30 x 7 cm	69,95 €
930671	mounting frame 120 x 30 cm	69,95 €
optional power supplies CC, 1050mAh, 40W		
862193	power supply MULTI-CC DALI1/2/Intelli-Push dimmable 14-43V 14,7-45,0 W	74,95 €
862175	power supply Meanwell KNX dimmable 2-100V 42,0 W	144,95 €
862244	power supply Meanwell mit Casambi-App dimmable 2-100V 42,0 W	249,95 €





LED PANEL STANDARD HCL

- aluminium
- dimensions L x B x H: 620 x 620 x 10 mm
- dimmable via optional controller

item	colour	colour temperature	light current	price
100032	<input type="checkbox"/> white	<input checked="" type="checkbox"/> ww <input checked="" type="checkbox"/> cw 3000-5500 K	3551 lm	149,95 €



accessories

930665	surface mounting frame 62,5 x 62,5 x 7 cm	59,95 €
930670	mounting frame 62,5 x 62,5 cm	59,95 €
862122	power supply 24V DC 50 W	59,95 €
862166	power supply 24V DC 100 W	104,95 €
843057	RF controller Set White 12/24/48V	109,95 €

additional controller and dimmer from page 735
 additional power supplies from page 697

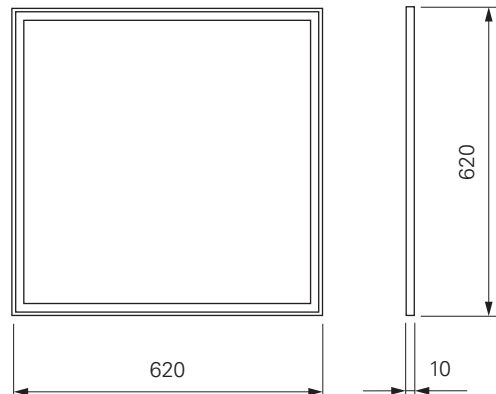



LED PANEL STANDARD RGBW

- aluminium
- dimensions L x B x H: 620 x 620 x 11,9 mm
- particularly powerful and intense colours
- dimmable via optional controller

item	colour	colour temperature	light current	power RGB	power W	price
100152	<input type="checkbox"/> white	3000 K	4000 lm	3x 18W	40W	189,95 €
100153	<input type="checkbox"/> white	4000 K	4200 lm	3x 18W	40W	189,95 €

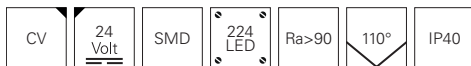

accessories

930665	surface mounting frame 62,5 x 62,5 x 7 cm	59,95 €
930670	mounting frame 62,5 x 62,5 cm	59,95 €
862166	power supply 24V DC 100 W IP20	104,95 €
872091	power supply 24V DC 320 W IP67	239,95 €
843059	RF controller Set RGB+White 12/24/48V	119,95 €

additional controller and dimmer from page 735
 additional power supplies from page 697

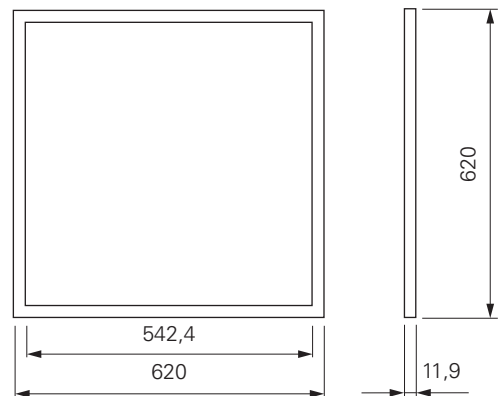



□ ■
page 170



□ ■
page 172



□ ■
page 173



□ □ ■
page 174



□ □ ■
page 174



□ □
page 176



□ □
page 178



□ □
page 179



■ ■ □
page 180



■ ■ ■
page 182



□ ■ ■
■ ■
page 182



■
page 184



■ ■ ■
page 186



■
page 188



■
page 188



■
page 189



■
page 189



□
page 190



□
page 190

surface mounted wall lights



□
page 191



□
page 191



□
page 192

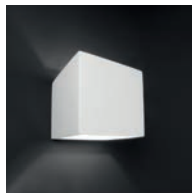

□
page 192

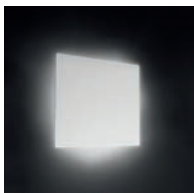

□
page 192



□
page 193



□
page 193



□
page 193



□
page 194



□
page 194



□
page 194



■
page 196



BERMUDA II

Clear design language, visual highlight! With the BERMUDA luminaire series developed by our designer Johannes Tomm, you can create a feel-good atmosphere far away from the typical »0815«.

Whether elegant wall lamp, unusual table and floor lamp or even the lighting of your garden – the BERMUDA series gives every lighting situation its own special touch.



BERMUDA II

- Design by Johannes Tomm
- easy mounting
- 360° beam angle
- aluminium diecast
- dimensions L x H: 123 x 200 mm
- socket H x Ø: 93 x 70 mm

item	colour	colour temperature	light current	price
342159	□ white	ww 3000 K	655 lm	135,95 €
342160	■ black	ww 3000 K	655 lm	135,95 €



suitable
table /
floor lights
page 212/213
346018
346017
343029
343028



suitable
wall light
IP65
page 418
731124



suitable
bollard light
IP65
page 382
731124



suitable
ground spike
lights
IP65
page 456
733060
733059





ASTEROPE LINEAR

Light & shadow: Hardly any luminaire embodies this dualism more beautifully than the ASTEROPE in its various versions. The wall luminaire, which is open at the top and bottom, creates a multifaceted play of light and shadow on walls and ceilings that blends extravagantly yet harmoniously into any ambience.



suitable
pendant lights
page 11
342135
342136

ASTEROPE LINEAR

- metal
- dimensions L x W: 300 x 150 mm
- dimmable via optional illuminants

item	colour	price
341216	□ white	75,95 €
341217	■ black	75,95 €



suitable illuminants on page 769



suitable
table and
floor lights
page 216
346003
346004
343020
343021



UNI II

- aluminium diecast
- dimensions L x W x H x Ø: 120 x 95 x 205 x 100 mm
- socket L x W x H: 120 x 43 x 205 mm
- dimmable via phase control or phase cut-off

item	colour	colour temperature	light current	price
341215	white	3000 K	670 lm	179,95 €
341232	black	3000 K	670 lm	179,95 €

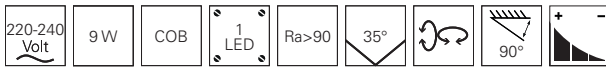

accessories

930339	reflector ring black	11,95 €
930340	reflector ring gold	11,95 €
930341	reflector ring chrome	11,95 €
930371	reflector ring II black glossy	10,95 €
930335	cover backside black	3,55 €
930337	cover heatsink black	3,55 €
930306	reflector 50°	10,95 €
930307	honeycomb filter	10,95 €
930308	spread lens 40° clear/satined	10,95 €
930309	softening lens 47° satined	10,95 €
930310	linear spread lens 40°/80° asymmetric clear/satined	10,95 €

ARIETIS

A modern wall lamp with outstanding design and glare-free light. The ARIETIS impresses with its clear line, the beautiful and very elegant finish in polished aluminium and convinces completely with the built-in G9 socket. This gives you the possibility to choose the right illuminant for you. Whether halogen or LED, warm white or cool white, you have the strings in your hand. Hardly any other luminaire emphasises your modern lifestyle like the ARIETIS.

ARIETIS

- aluminium diecast
- dimensions L x W x H: 170 x 85 x 70 mm
- socket L x W x H: 120 x 45 x 20 mm
- dimmable via optional illuminants

item	colour	price
341188	<input type="checkbox"/> white	79,95 €
341189	<input type="checkbox"/> silver coloured	79,95 €
341190	<input type="checkbox"/> black	79,95 €



suitable illuminants on page 766

ACAMAR

Small, noble, elegant and unobtrusive – the ACAMAR is a luminaire made of high-quality aluminium. The colour rendering value is over 90, which means high colour fastness. The design is chic and interesting due to the single-sided rounding. You can mount the luminaire with the rounding upwards or downwards, depending on your preference. The white lacquering on the inside emphasises the warm white light and distributes it pleasantly upwards and downwards. The outside is highly polished and thus shines in full brilliance.

ACAMAR

- aluminium diecast
- dimensions L x W x H: 170 x 100 x 80 mm
- socket L x W x H: 120 x 60 x 33 mm
- dimmable via phase control or phase cut-off

item	colour	colour temperature	light current	price
341194	<input type="checkbox"/> white	3000 K	390 lm	124,95 €
341195	<input type="checkbox"/> silver coloured	3000 K	400 lm	124,95 €
341196	<input type="checkbox"/> black	3000 K	250 lm	124,95 €



With the kind support of Regionaldirektion für Deutsche Vermögensberatung Pierre Werner / Direktion für Deutsche Vermögensberatung Uwe Liebholz



CANOPUS

Our light chameleon: extraordinary design meets innovative dimmer technology. The further you dim the CANOPUS, the warmer the light becomes. No luminaire comes close to real candlelight - but the CANOPUS is not far off. Elegant, glare-free and modern ambient lighting at its best!

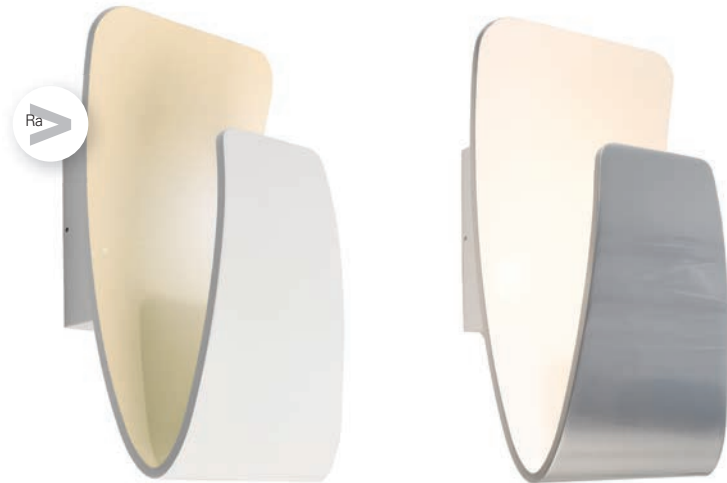

CANOPUS

- aluminium diecast
- dimensions L x W x H: 140 x 115 x 265 mm
- socket L x W x H: 110 x 110 x 33 mm
- dim to warm

item	colour	colour temperature	light current	price
341197	<input type="checkbox"/> white	2000-3000 K	900 lm	214,95 €
341198	<input type="checkbox"/> silver coloured	2000-3000 K	900 lm	214,95 €









PARALA & LARGA

The simple PARALA and LARGA wall-mounted luminaires impress with their linear design and high-quality aluminium housing, which is available in two different finishes. However, they not only set the stage with their modern housing shape, but also create a pleasant lighting atmosphere with their indirect warm white light source.



PARALA 425

- aluminium diecast
- dimensions L x W x H: 425 x 44 x 34 mm
- socket L x W x H: 170 x 44 x 34 mm

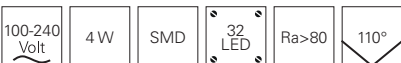

item	colour	colour temperature	light current	price
341208	<input type="checkbox"/> white satined	 3000 K	440 lm	109,95 €
341207	<input type="checkbox"/> silver coloured brushed	 3000 K	440 lm	109,95 €





LARGA 910

- aluminium diecast
- dimensions L x W x H: 910 x 44 x 44 mm
- socket L x W x H: 170 x 44 x 37 mm

item	colour	colour temperature	light current	price
341210	<input type="checkbox"/> white satined	 3000 K	770 lm	214,95 €
341209	<input type="checkbox"/> silver coloured brushed	 3000 K	770 lm	214,95 €

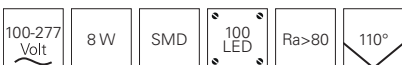

APODIS

Luminaire or piece of jewellery? We are happy to leave the decision to you. However, the APODIS in its two lengths and surface finishes in gold and rose gold is a timeless and flexible lighting element that decorates every wall with its dimmable, two-sided LED light emission.



APODIS 500

- aluminium
- dimensions L x W x H: 76 x 61 x 500 mm
- socket L x W x H: 60 x 18 x 100 mm
- dimmable via phase control or phase cut-off

item	colour	colour temperature	light current	price
341200	gold optics	3000 K	350 lm	189,95 €
341201	rosé	3000 K	350 lm	189,95 €



APODIS 800

- aluminium
- dimensions L x W x H: 76 x 61 x 800 mm
- socket L x W x H: 60 x 18 x 100 mm
- dimmable via phase control or phase cut-off

item	colour	colour temperature	light current	price
341202	gold optics	3000 K	450 lm	229,95 €
341203	rosé	3000 K	450 lm	229,95 €







CUBE

- concrete
- dimensions L x W x H: 115 x 115 x 115 mm
- dimmable via optional illuminants

item	colour	price
341183	grey	81,95 €
341184	dark grey	81,95 €
341185	beige	81,95 €



suitable illuminants on page 766

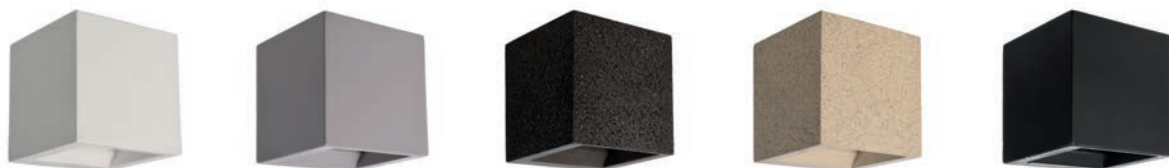

MINI CUBE

- aluminium
- dimensions L x W x H: 80 x 80 x 65 mm
- socket Ø: 100 mm

item	colour	colour temperature	light current	price
620137	gypsum white	3000 K	350 lm	85,95 €
620136	concrete grey	3000 K	350 lm	85,95 €
620139	concrete grey granite	3000 K	350 lm	85,95 €
620138	concrete beige granite	3000 K	350 lm	85,95 €
620140	concrete black	3000 K	350 lm	85,95 €

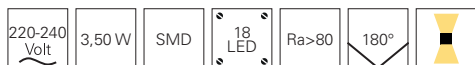



QUINTA II

Concrete – Cube – LED module what more could you want? The timeless shape of the cube was made of concrete and equipped with an efficient 6 Watt LED module. This combination makes QUINTA II the ideal luminaire for many interior applications. Whether as room light or accent lighting, with QUINTA II you are definitely on the fast track in terms of design.



QUINTA II

- concrete
- dimensions L x W x H: 125 x 60 x 125 mm
- socket L x W x H: 100 x 80 x 45 mm

item	colour	colour temperature	light current	price
341180	 grey	 3000 K	250 lm	129,95 €

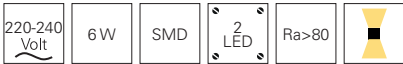



YPSILON

Geometric design and maximum variability – the YPSILON consists of two parts, a base and the name-giving interchangeable Y-part. Thanks to the round base and the variable mounting, one or more YPSILON luminaires can be used to create highly interesting light effects on walls. Just a few degrees of rotation creates a completely different light image. Thanks to the many different materials, e.g. white plaster, which can also be customised, or grey granite, almost impossible variations can be conjured up.



YPSILON

- aluminium | gypsum | concrete
- dimensions L x W x H: 245 x 232 x 65 mm
- socket Ø: 100 mm

item	colour	colour temperature	light current	price
620132	■ gypsum white paintable	☀ 3000 K	350 lm	106,95 €
620135	■ concrete grey granite	☀ 3000 K	350 lm	106,95 €
620134	■ concrete beige granite	☀ 3000 K	350 lm	106,95 €
620133	■ concrete black	☀ 3000 K	350 lm	106,95 €

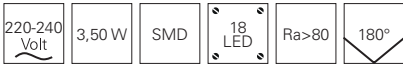





ARIANNA II

- concrete
- dimensions L x W x H: 200 x 85 x 120 mm
- socket L x W x H: 135 x 3 x 65 mm
- dimmable via optional illuminants

item	colour	price
341187	 grey	69,95 €



suitable illuminants on page 766



SARIN

- concrete
- dimensions L x W x H: 300 x 100 x 75 mm
- socket L x W x H: 158 x 38 x 53 mm
- dimmable via optional illuminants

item	colour	price
341178	 grey	69,95 €



suitable illuminants on page 769

ATRIA

- concrete
- dimensions L x W x H: 180 x 100 x 90 mm
- socket L x W x H: 65 x 71 x 19 mm
- dimmable via optional illuminants

item	colour	price
341176	 grey	85,95 €



suitable illuminants on page 766



OSANO II

- concrete
- dimensions L x W x H: 150 x 130 x 128 mm
- socket L x W x H: 58 x 63 x 23 mm
- dimmable via optional illuminants

item	colour	price
341177	 grey	69,95 €



suitable illuminants on page 766



FLY

FLY is a wall-mounted luminaire based on a patented design by Johannes Tomm, available exclusively from DEKO-LIGHT. With its unusual plaster construction, the FLY can be individually designed and creates an indirect, glare-free light that blends into different spaces without any problems.



FLY I + II

- gypsum
- dimensions L x W x H: 240 x 123 x 170 mm
- socket H x Ø: 60 x 100 mm
- dimmable via phase control or phase cut-off

item	colour	colour temperature	light current	price
341222	<input type="checkbox"/> white paintable	 3000 K	310 lm	109,95 €
341224	<input type="checkbox"/> white paintable	 3000 K	310 lm	109,95 €

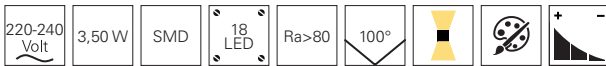



DL TWYNNDA I + II

- gypsum
- dimensions L x W x H: 321 x 120 x 130 mm
- socket L x W: 198 x 20 mm
- dimmable via optional illuminants

item	colour	price
341205	<input type="checkbox"/> white paintable	55,95 €
341206	<input type="checkbox"/> white paintable	55,95 €

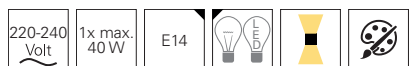

suitable illuminants on page 769

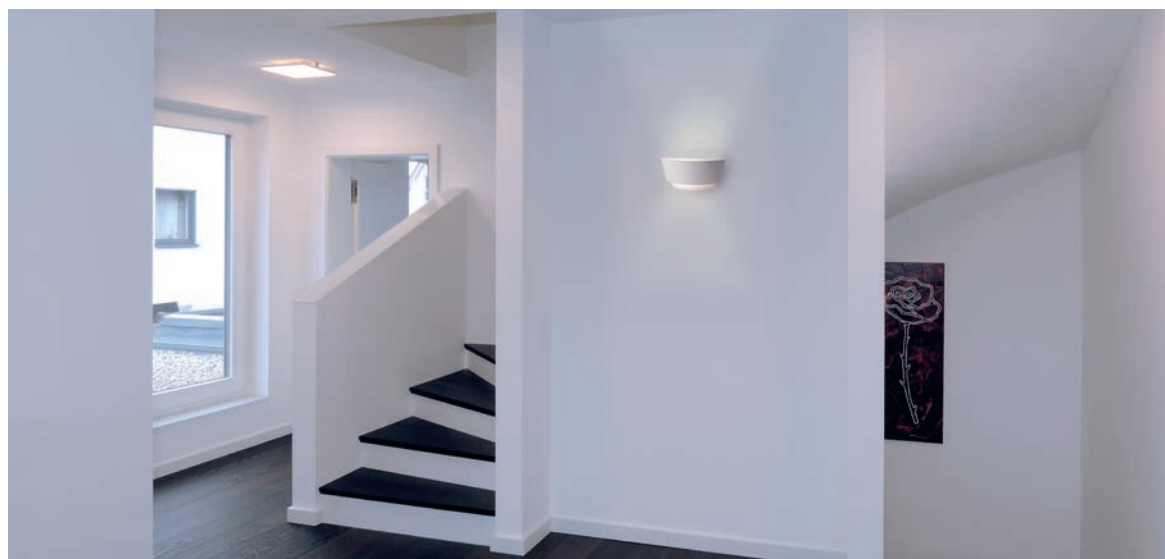

GIORGIA

- gypsum
- dimensions L x W x H: 70 x 100 x 120 mm
- socket L x W: 90 x 45 mm
- dimmable via optional illuminants

item	colour	price
341033	<input type="checkbox"/> white paintable	49,95 €



suitable illuminants on page 766

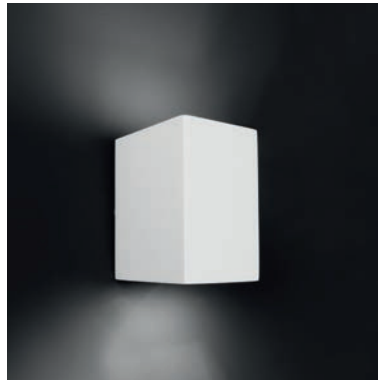

OLGA

- gypsum
- dimensions L x W x H: 142 x 142 x 140 mm
- socket L x W x H: 120 x 120 x 17 mm
- dimmable via optional illuminants

item	colour	price
341225	<input type="checkbox"/> white paintable	51,95 €



suitable illuminants on page 766



RELONO

- gypsum
- dimensions L x W x H: 260 x 90 x 300 mm
- socket L x W: 180 x 180 mm
- dimmable via optional illuminants

item	colour	price
341010	<input type="checkbox"/> white paintable	59,95 €



suitable illuminants on page 769

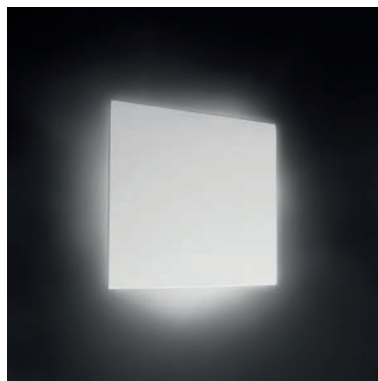

ESSA

- gypsum
- dimensions L x W x H: 255 x 75 x 100 mm
- socket L x W: 88 x 58 mm
- dimmable via optional illuminants

item	colour	price
341105	<input type="checkbox"/> white paintable	64,95 €



suitable illuminants on page 767-768

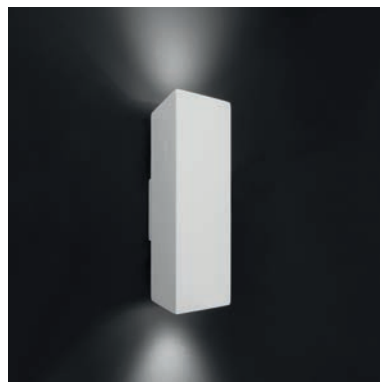

QUINTA

- gypsum
- dimensions L x W x H: 125 x 60 x 125 mm
- socket L x W: 100 x 60 mm

item	colour	colour temperature	light current	price
341062	<input type="checkbox"/> white paintable	 3000 K	270 lm	99,95 €

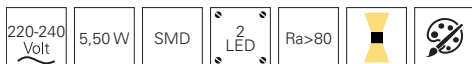

ARIANNA

- gypsum
- dimensions L x W x H: 300 x 95 x 140 mm
- socket L x W: 155 x 20 mm
- dimmable via optional illuminants

item	colour	price
341035	<input type="checkbox"/> white paintable	69,95 €



suitable illuminants on page 774



NETITO

- gypsum
- dimensions L x W x H: 245 x 123 x 92 mm
- socket L x W: 180 x 14 mm
- dimmable via optional illuminants

item	colour	price
341057	<input type="checkbox"/> white paintable	69,95 €



suitable illuminants on page 774



CAROLINE

- gypsum
- dimensions L x W x H: 377 x 177 x 121 mm
- socket L x W x H: 215 x 62 x 20 mm
- dimmable via optional illuminants

item	colour	price
341223	<input type="checkbox"/> white paintable	99,95 €



suitable illuminants on page 770-771



OSANO

- gypsum
- dimensions L x W x H: 150 x 115 x 125 mm
- socket L x W: 62 x 57 mm
- dimmable via optional illuminants

item	colour	price
341065	<input type="checkbox"/> white paintable	52,95 €



suitable illuminants on page 766

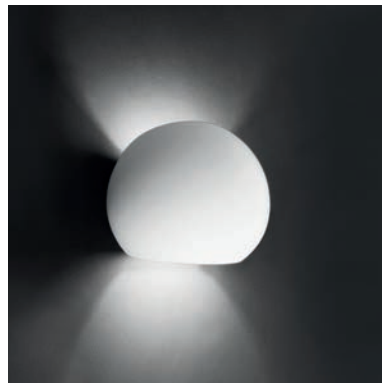

CREATIVE IDEAS FOR YOUR PLASTER LUMINAIRES

Plaster luminaires are very easy to design individually. After priming [e.g. with deep primer], you can paint, spray, varnish or even glue on the plaster surface. Experienced designers carefully remove or apply material and thus create a real one-of-a-kind luminaire – as in the three examples below, which were individually designed and have since caused a stir not only in the living room, hallway and staircase area, but also in the children's room...



MADERA

The MADERA series is made of first-class European oak wood and impresses with its modern design and mix of materials in private living areas, hotels, restaurants and many more. The noble MADERA luminaires distribute their powerful warm white light in any room and thus also cut an excellent figure as functional and high-quality lighting at reception counters and more.



suitable
ceiling lights
page 89
348147



suitable
pendant light
page 46
342169



suitable
table /
floor lights
page 220
346044
343031

MADERA

- modern, exclusive design
- from high-quality oak wood of grade A
- FSC-certified raw material oak wood
- environmentally friendly packaging
- oak wood | aluminium
- dimensions L x W x H: 450 x 60 x 130 mm
- socket L x W x H: 250 x 60 x 30 mm

item	colour	colour temperature	light current	price
341248	■ wood, black	■ 3000 K	560 lm	259,95 €

220-240 Volt	7 W	LED	Ra>80
-----------------	-----	-----	-------





□
page 200



□ □ ■
page 200



□ □ ■
page 200



□ □ ■
page 200



□ □ ■
page 200



□
page 201



□ □ ■
page 201



□ □ ■
page 201



□ □ ■
page 201



□ □ ■
page 201

built in wall lights



ALWAID 2

ALWAID is your problem solver when space is tight. Thanks to its small design, the recessed wall luminaire fits into all 68 mm deep switch boxes and does not require a power supply unit.

With its numerous covers, it blends safely into its surroundings and presents a beautiful indirect light that can be dimmed.

ALWAID 2

- aluminium diecast
- dimensions H x Ø: 40 x 71 mm
- dimmable via phase control or phase cut-off
- suitable for 68 mm switch boxes in deep version



item	colour	colour temperature	light current	price
563009	<input type="checkbox"/> white	2700 K	230 lm	79,95 €

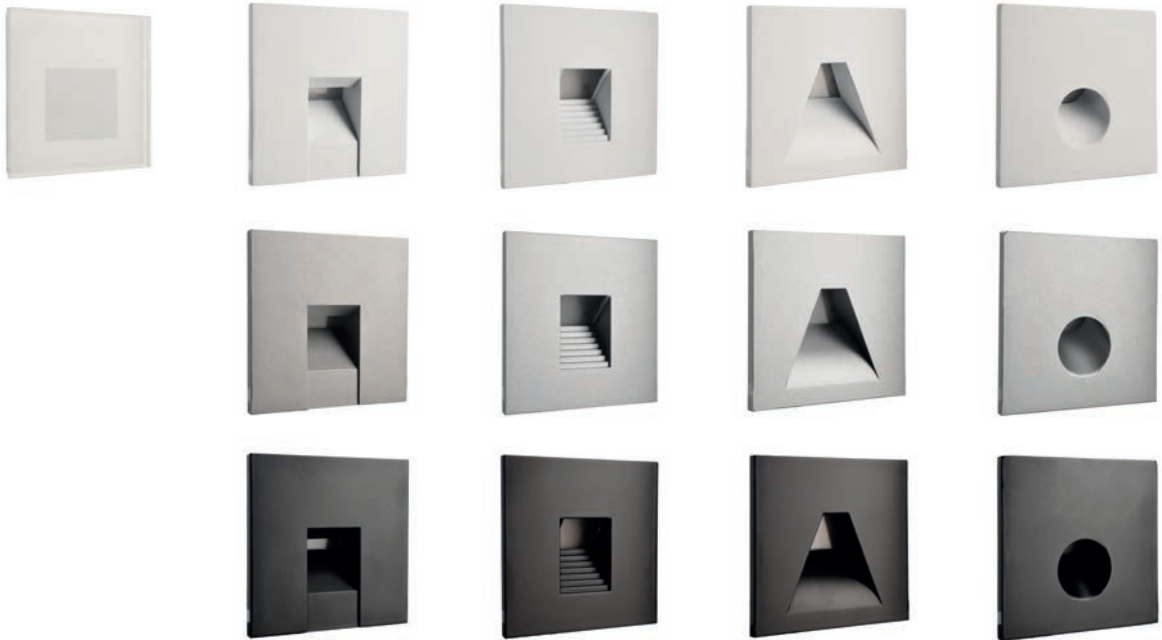
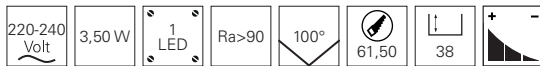

cover

930480	<input type="checkbox"/> angular milky white L x W x H: 78 x 78 x 22 mm	21,95 €
930482	<input type="checkbox"/> angular square white L x W x H: 75 x 75 x 22 mm	17,95 €
930485	<input type="checkbox"/> angular step white L x W x H: 75 x 75 x 22 mm	17,95 €
930488	<input type="checkbox"/> angular trapeze white L x W x H: 75 x 75 x 22 mm	17,95 €
930491	<input type="checkbox"/> angular round white L x W x H: 75 x 75 x 22 mm	17,95 €
930483	<input type="checkbox"/> angular square aluminium L x W x H: 75 x 75 x 22 mm	17,95 €
930486	<input type="checkbox"/> angular step aluminium L x W x H: 75 x 75 x 22 mm	17,95 €
930489	<input type="checkbox"/> angular trapeze aluminium L x W x H: 75 x 75 x 22 mm	17,95 €
930492	<input type="checkbox"/> angular round aluminium L x W x H: 75 x 75 x 22 mm	17,95 €
930484	<input checked="" type="checkbox"/> angular square black L x W x H: 75 x 75 x 22 mm	17,95 €
930487	<input checked="" type="checkbox"/> angular step black L x W x H: 75 x 75 x 22 mm	17,95 €
930490	<input checked="" type="checkbox"/> angular trapeze black L x W x H: 75 x 75 x 22 mm	17,95 €
930493	<input checked="" type="checkbox"/> angular round black L x W x H: 75 x 75 x 22 mm	17,95 €

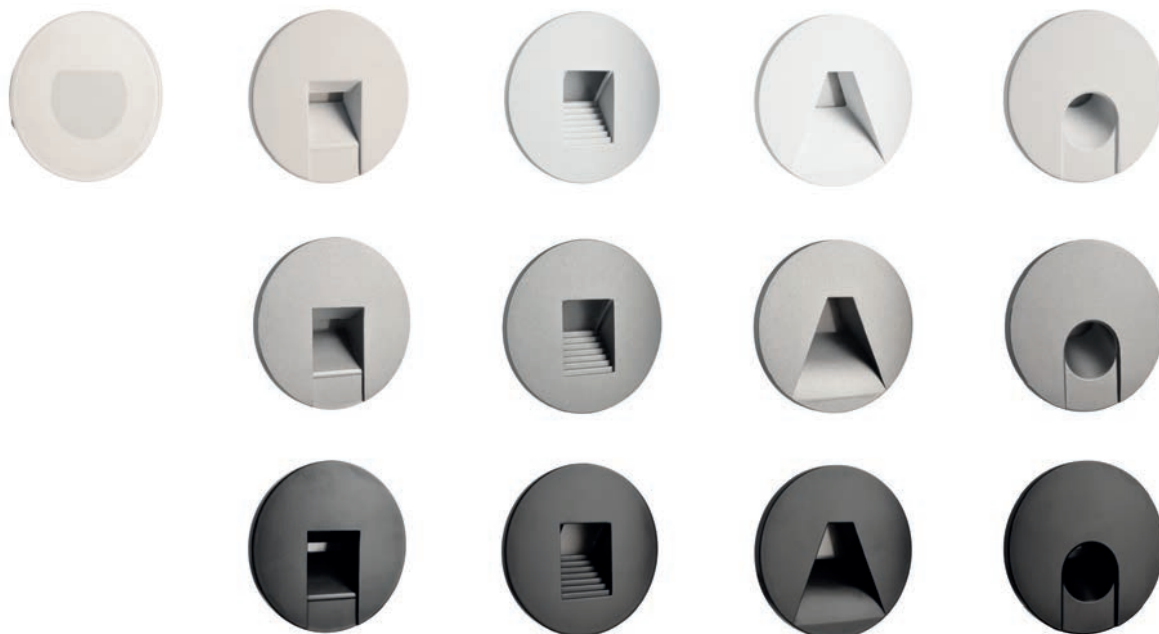
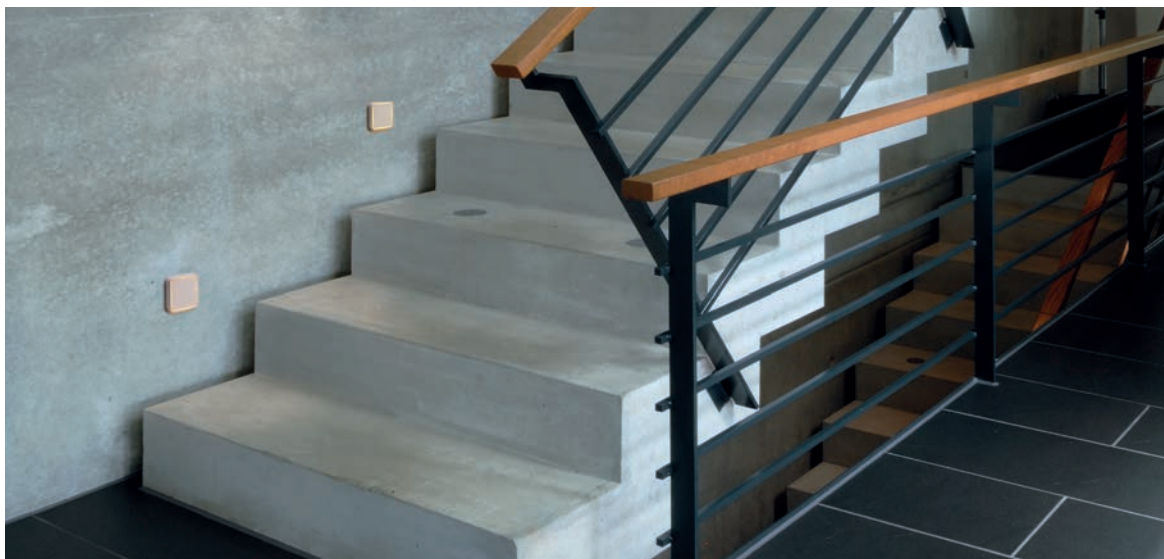

cover

930481	<input type="checkbox"/> round milky white H x Ø: 22 x 78 mm	21,95 €
930500	<input type="checkbox"/> round square white H x Ø: 22 x 78 mm	17,95 €
930497	<input type="checkbox"/> round step white H x Ø: 22 x 78 mm	17,95 €
930503	<input type="checkbox"/> round trapeze white H x Ø: 22 x 78 mm	17,95 €
930494	<input type="checkbox"/> round round white H x Ø: 22 x 78 mm	17,95 €
930501	<input type="checkbox"/> round square aluminium H x Ø: 22 x 78 mm	17,95 €
930498	<input type="checkbox"/> round step aluminium H x Ø: 22 x 78 mm	17,95 €
930504	<input type="checkbox"/> round trapeze aluminium H x Ø: 22 x 78 mm	17,95 €
930495	<input type="checkbox"/> round round aluminium H x Ø: 22 x 78 mm	17,95 €
930502	<input checked="" type="checkbox"/> round square black H x Ø: 22 x 78 mm	17,95 €
930499	<input checked="" type="checkbox"/> round step black H x Ø: 22 x 78 mm	17,95 €
930505	<input checked="" type="checkbox"/> round trapeze black H x Ø: 22 x 78 mm	17,95 €
930496	<input checked="" type="checkbox"/> round round black H x Ø: 22 x 78 mm	17,95 €



page 205



page 205



page 207

reading lights





BRAHE IV

Whether as a wall lamp next to the bed, as a bedside lamp or as a floor lamp behind the reading chair – when you put the book or newspaper away, conventional reading lights often lack indirect lighting options. Here the BRAHE comes into play with its illuminated socket, which can be switched separately and creates atmospheric, indirect islands of light that provide the right light even after reading.



BRAHE I

- modern design
- individually adjustable via flexible arm and thus optimal as a reading light
- aluminium
- dimensions L x H x Ø: 310 x 80 x 25 mm
- socket L x W x H: 80 x 80 x 25 mm

item	colour	colour temperature	light current	price
341236	□ white	ww 3000 K	175 lm	59,95 €
341237	■ black	ww 3000 K	165 lm	59,95 €

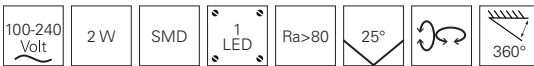

suitable
table and
floor lights
page 210
346015
346016
343025
343026



BRAHE IV

- modern design
- direct and indirect lighting can be switched separately
- impresses with simplicity and elegance
- aluminium
- dimensions B x Ø: 110 x 150 mm
- primary light: 2,00 W / 1 LED
- ambient light: 4,80 W / 48 LED

item	colour	colour temperature	light current	price
341242	□ white	ww 3000 K	490 lm	89,99 €
341243	■ black	ww 3000 K	395 lm	89,99 €



suitable
table and
floor lights
page 210
346015
346016
343025
343026



ALWA

The ALWA combines two luminaires in one sophisticated design: a bedside luminaire with indirect shade lighting and a reading spot. The highlight is the rotatable and swivelling arm [tilt angle: 90°], which enables the ALWA to provide targeted illumination. With its narrow beam angle of 20°, the ALWA also ensures that the person next to the bed is guaranteed not to be disturbed. We wish you a pleasant night's sleep.



ALWA I

- modern design
- flexible application possibilities due to rotatable luminaire body
- ideal as bed and reading lamp
- aluminium
- dimensions L x Ø: 110 x 30 mm
- socket L x W x H: 135 x 50 x 28 mm

item	colour	colour temperature	light current	price
341228	□ white	☀ 3000 K	200 lm	115,95 €
341229	■ black	☀ 3000 K	180 lm	115,95 €





page 210



page 210



page 212



page 213



page 215



page 215



page 216



page 216



page 218



page 218



page 220



page 220

table and floor lights





BRAHE

- modern design
- direct and indirect lighting can be switched separately
- impresses with simplicity and elegance
- aluminium
- dimensions L x Ø: 455 x 150 mm
- primary light: 2,00 W / 1x LED
- ambient light: 4,80 W / 48x LED

item	colour	colour temperature	light current	price
346015	white	3000 K	470 lm	122,95 €
346016	black	3000 K	370 lm	122,95 €



suitable
reading lights
page 205
341242
341243
341236
341237



BRAHE

- modern design
- direct and indirect lighting can be switched separately
- impresses with simplicity and elegance
- aluminium
- dimensions L x Ø: 1387 x 305 mm
- primary light: 3,00 W / 1x LED
- ambient light: 8,00 W / 72x LED

item	colour	colour temperature	light current	price
343025	white	3000 K	530 lm	199,95 €
343026	black	3000 K	530 lm	199,95 €



suitable
reading lights
page 205
341242
341243
341236
341237



BERMUDA

Whether as a decorative element or for reading – the 38 cm high BERMUDA table lamp can be switched between the light colours warm white, neutral white and cool white as well as dimmed via an integrated touch sensor.



suitable
wall lights
page 170
342159
342160



suitable
wall light
IP65
page 418
731124



suitable
bollard light
IP65
page 382
733056

BERMUDA

- design by Johannes Tomm
- colour temperature selectable via touch switch
- 360° beam angle
- aluminium diecast
- dimensions H x Ø: 380 x 200 mm
- socket H x Ø: 20 x 150 mm
- infinitely dimmable via touch sensor

item	colour	colour temperature	light current	price
346018	white	ww nw cw 3000 / 4000 / 5000 K	935 lm	169,95 €
346017	black	ww nw cw 3000 / 4000 / 5000 K	935 lm	169,95 €

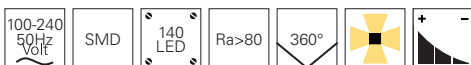

suitable
ground spike
lights
IP65
page 456
733060
733059

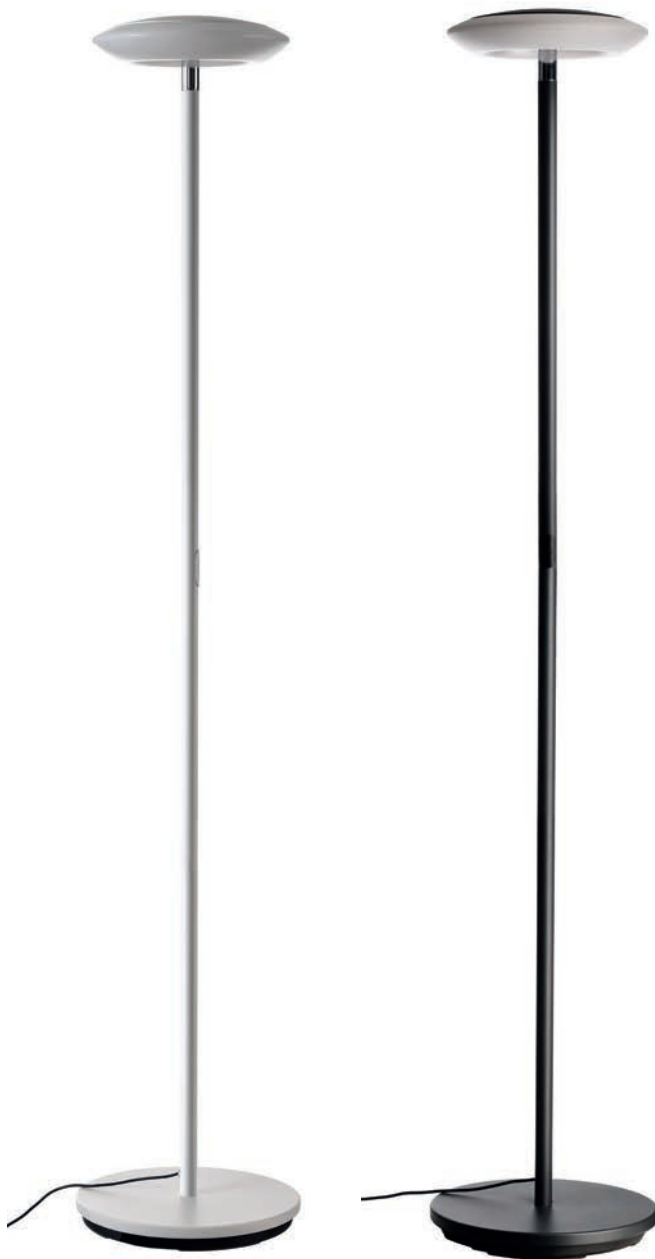

suitable
wall lights
page 170
342159
342160



suitable
wall light
IP65
page 418
731124



suitable
bollard light
IP65
page 382
733056



suitable
ground spike
lights
IP65
page 456
733060
733059

BERMUDA

- design by Johannes Tomm
- luminaire head can be tilted up to 30°
- 360° beam angle
- aluminium diecast
- dimensions L x H: 1708 x 250 mm
- socket H x Ø: 26 x 250 mm
- infinitely dimmable via touch sensor

item	colour	colour temperature	light current	price
343029	□ white	ww 3000 K	715 lm	189,95 €
343028	■ black	ww 3000 K	715 lm	189,95 €





ADHARA

Classic design interpreted in a modern way – the ADHARA made of aluminium impresses with its classic lines, state-of-the-art materials and high flexibility. Thanks to the three joints, ADHARA can be optimally adjusted to any situation. Its powerful LED module delivers 640/800 lumens and can also be dimmed thanks to the touch sensor. Whether in an executive's office or at a child's desk, ADHARA cuts a fine figure everywhere.



ADHARA

- practical design
- double adjustable and fixable via joints
- 3-level dimmable via touch sensor
- aluminium
- socket H x Ø: 16 x 160 mm / 22 x 180 mm

item	colour	colour temperature	light current	dimensions L x Ø	price
346030	white	3000 K	950 lm	355 x 150 mm	109,95 €
346031	silver coloured	3000 K	950 lm	355 x 150 mm	109,95 €
346029	black	3000 K	950 lm	355 x 150 mm	109,95 €
346027	white	3000 K	950 lm	480 x 150 mm	169,95 €
346028	silver coloured	3000 K	950 lm	480 x 150 mm	169,95 €
346026	black	3000 K	950 lm	480 x 150 mm	169,95 €

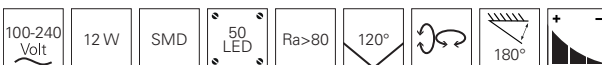

ASTEROPE

Light & shadow: Hardly any luminaire embodies this dualism more beautifully than the ASTEROPE in its various versions. The downward-opening pendant luminaire creates a multifaceted play of light and shadow on walls and ceilings that blends extravagantly yet harmoniously into any ambience.

Our tip: Combine the ASTEROPE with a gold-coloured or milky light source from the Filament series.

ASTEROPE LINEAR

- metal
- dimensions H x Ø: 450 x 150 mm
- socket H x Ø: 25 x 150 mm
- incl. 2 m connection cable with switch

item	colour	price
346003	<input type="checkbox"/> white	115,95 €
346004	<input checked="" type="checkbox"/> black	115,95 €



suitable illuminants on page 770, 771, 773



suitable
pendant lights
page 11
342135
342136



suitable
wall lights
page 172
341216
341217

ASTEROPE LINEAR

- metal
- dimensions H x Ø: 1600 x 210 mm
- socket H x Ø: 30 x 250 mm
- incl. 2,30 m connection cable with switch

item	colour	price
343020	<input type="checkbox"/> white	199,95 €
343021	<input checked="" type="checkbox"/> black	199,95 €



suitable illuminants on page 770, 771, 773



suitable
pendant lights
page 11
342135
342136



suitable
wall lights
page 172
341216
341217



TWISTER

Elegant design with innovative details meets unusual choice of materials: The TWISTER series combines decorative floor, table and pendant luminaires in different sizes, made entirely of plaster. We turn the cable into a design element! Completely in classic white, the luminaires are only interrupted by a red cable. This makes the TWISTER series an eye-catcher not only in living areas but also in hotels and restaurants.

TWISTER

- design by Johannes Tomm
- red textile cable
- gypsum
- easy cleaning through surface treatment
- dimensions H x Ø: 350 x 180 mm

item	colour	price
346010	<input type="checkbox"/> white	129,95 €



suitable illuminants on page 766



suitable
pendant lights
page 70
342144
342145

TWISTER

- design by Johannes Tomm
- red textile cable
- gypsum
- easy cleaning through surface treatment
- dimensions L x H x Ø: 282 x 1500 x 280 mm
- socket H x Ø: 25 x 270 mm

item	colour	price
343017	<input type="checkbox"/> white	219,95 €



suitable illuminants on page 770-773



suitable
pendant lights
page 70
342144
342145



MADERA

The MADERA series is made of first-class European oak wood and impresses with its modern design and mix of materials in private living areas, hotels, restaurants and many more. The noble MADERA luminaires distribute their powerful warm white light in any room and thus also cut an excellent figure as functional and high-quality lighting at reception counters and more.

MADERA

- modern, exclusive design
- manufactured in Europe from high-quality oak wood of grade A
- FSC-certified raw material oak wood
- environmentally friendly packaging
- infinitely dimmable via touch sensor
- oak wood | aluminium
- dimensions L x W x H: 40 x 60 x 510 mm
- socket L x W x H: 160 x 130 x 6 mm



suitable ceiling light
page 89
348147



suitable pendant light
page 46
342169



suitable wall light
page 196
341248

item	colour	colour temperature	light current	price
346044	■ wood, black	ww 3000 K	420 lm	329,95 €

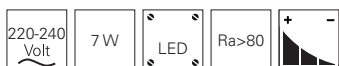

MADERA

- modern, exclusive design
- manufactured in Europe from high-quality oak wood of grade A
- FSC-certified raw material oak wood
- environmentally friendly packaging
- infinitely dimmable via touch sensor
- oak wood | aluminium
- dimensions L x W x H: 40 x 60 x 1410 mm
- socket L x W x H: 250 x 180 x 6 mm



suitable ceiling light
page 89
348147



suitable pendant light
page 46
342169



suitable wall light
page 196
341248

item	colour	colour temperature	light current	price
343031	■ wood, black	ww 3000 K	1610 lm	529,95 €

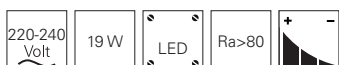





■ □
page 224



□ □
page 225



□ □
from page 226



□ □
page 228



□ □
page 229



□ □
page 230



□ □
page 231



□ □
from page 232



□
page 234



□
page 234



□
page 235

furniture lights



MIA

With their wide range of accessories, the versatile furniture luminaires of the MIA series offer the right solution for every situation. Whether in horizontal or vertical alignment – MIA convinces with its high light output and homogeneous illumination. It is conveniently controlled via touch dimmer or via a configurable PIR motion sensor.



MIA

- aluminium
- dimensions B x H: 38 x 8 mm
- dimmable via optional accessories

item	colour	colour temperature	light current	dimensions L	power	price
687062	silver coloured / black	3000 K	210 lm	300 mm	5 W	45,95 €
687064	silver coloured / black	4000 K	250 lm	300 mm	5 W	45,95 €
687070	silver coloured / black	3000 K	330 lm	500 mm	8 W	65,95 €
687071	silver coloured / black	4000 K	350 lm	500 mm	8 W	65,95 €
687072	silver coloured / black	3000 K	800 lm	1000 mm	14 W	119,95 €
687073	silver coloured / black	4000 K	620 lm	1000 mm	14 W	119,95 €



accessories

930212	touch dimmer black	13,95 €
930213	IR sensor black	22,95 €
930160	connector linear black	2,25 €
930191	angle connector flat black	3,25 €
930209	angle connector vertical black	3,95 €
687117	connection cable black 150 mm	2,25 €
687118	connection cable black 250 mm	2,25 €
930243	connection cable black 1000 mm	3,25 €
930242	mounting clips adjustable set of 2 plastic transparent	4,25 €
930214	mounting clips set of 5 metal silver coloured	1,10 €
862037	power plug unit 24V DC 6 W 1,5 m cable	15,95 €
862038	power plug unit 24V DC 24 W 1,5 m cable	29,95 €
862074	power plug unit 24V DC 36 W 1,5 m cable	39,95 €

MIA

- aluminium
- dimensions B x H: 38 x 8 mm
- dimmable via optional accessories



item	colour	colour temperature	light current	dimensions L	power	price
687074	<input type="checkbox"/> white	WW 3000 K	210 lm	300 mm	5 W	45,95 €
687075	<input type="checkbox"/> white	NW 4000 K	250 lm	300 mm	5 W	45,95 €
687076	<input type="checkbox"/> white	WW 3000 K	330 lm	500 mm	8 W	66,95 €
687077	<input type="checkbox"/> white	NW 4000 K	350 lm	500 mm	8 W	66,95 €
687078	<input type="checkbox"/> white	WW 3000 K	800 lm	1000 mm	14 W	119,95 €
687079	<input type="checkbox"/> white	NW 4000 K	620 lm	1000 mm	14 W	109,95 €





accessories

930250	touch dimmer white	11,95 €
930251	IR sensor white	24,95 €
930247	connector linear white	2,25 €
930248	angle connector flat white	3,25 €
930249	angle connector vertical white	4,55 €
930244	connection cable white 150 mm	1,75 €
930245	connection cable white 250 mm	1,75 €
930246	connection cable white 1000 mm	2,95 €
930242	mounting clips adjustable set of 2 plastic transparent	4,25 €
930214	mounting clips set of 5 metal silver coloured	1,10 €
862037	power plug unit 24V DC 6 W 1,5 m cable	15,95 €
862038	power plug unit 24V DC 24 W 1,5 m cable	29,95 €
862074	power plug unit 24V DC 36 W 1,5 m cable	39,95 €



BAHAM I

- aluminium
- dimensions H x Ø: 12,50 x 62 mm
- dimmable via optional power supply

item	colour	colour temperature	light current	price
687096	 silver coloured brushed	 3000 K	240 lm	33,95 €



accessories

872127	power supply 12V DC 4,0 W	13,95 €
862232	power supply 12V DC 20,0 W	26,95 €
862240	power supply dimmable 12V DC 2,5 - 25,0 W	64,95 €

SIMPLE, FAST, SAFE & POWERFUL



With our pre-assembled and ready-to-connect bundles, you are optimally prepared for current and future challenges in LED technology. In particular, carpenters as well as exhibition stand and shop fitters will find the right products for their ever-growing catalogue of requirements.

We are your partner when it comes to ready-to-plug-in solutions with high lumen packages. With our powerful bundles in numerous versions and configurations, customer requirements can be implemented quickly, efficiently and reliably.



BAHAM I BUNDLE OF 3

- 3 x surface-mounted/built-in furniture luminaire BAHAM I 687099
- dimensions H x Ø: 12,5 x 62 mm
- 1 x DEKO-LIGHT power supply dimmable 862169
- dimmable via phase control or phase cut-off
- incl. 6-fold AMP distributor [extension up to 6 luminaires]

item	colour	colour temperature	light current	price
620006	 silver coloured brushed	 3000 K	3x 240 lm	139,95 €

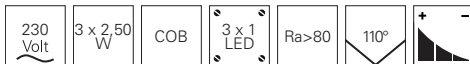

suitable pre-assembled accessories for extending the cabling on page 789



BAHAM I BUNDLE OF 5

- 5 x surface-mounted/built-in furniture luminaire BAHAM I 687099
- dimensions H x Ø: 12,5 x 62 mm
- 1 x DEKO-LIGHT power supply 862169
- dimmable via phase control or phase cut-off
- incl. 6-fold AMP distributor [extension up to 6 luminaires]

item	colour	colour temperature	light current	price
620007	 silver coloured brushed	 3000 K	5x 240 lm	199,95 €

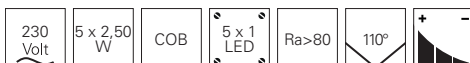

suitable pre-assembled accessories for extending the cabling on page 789

FINE I

- aluminium
- dimensions L x W x H: 60 x 60 x 5 mm
- dimmable via optional power supply



item	colour	colour temperature	light current	price
687034	grey	2700 K	210 lm	33,95 €



accessories

872127	power supply 12V DC 4,0 W	13,95 €
862232	power supply 12V DC 20,0 W	26,95 €
862240	power supply dimmable 12V DC 2,5 - 25,0 W	64,95 €



FINE I BUNDLE OF 3

- 3 x furniture surface-mounted luminaire FINE I 687034
- dimensions L x W x H: 60 x 60 x 5 mm
- 1 x DEKO-LIGHT power supply 862169
- dimmable via phase control or phase cut-off
- incl. 6-fold AMP distributor [extension up to 6 luminaires]

item	colour	colour temperature	light current	price
620012	grey	3000 K	3x 210 lm	169,95 €

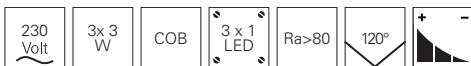

suitable pre-assembled accessories for extending the cabling on page 789



FINE I BUNDLE OF 5

- 5 x furniture surface-mounted luminaire FINE I 687034
- dimensions L x W x H: 60 x 60 x 5 mm
- 1 x DEKO-LIGHT power supply 862169
- dimmable via phase control or phase cut-off
- incl. 6-fold AMP distributor [extension up to 6 luminaires]

item	colour	colour temperature	light current	price
620013	grey	3000 K	5x 210 lm	229,95 €

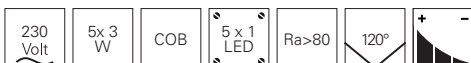

suitable pre-assembled accessories for extending the cabling on page 789

FINE II

- aluminium
- dimensions L x W x H: 190 x 60 x 5 mm
- dimmable via optional power supply



item	colour	colour temperature	light current	price
687035	grey	2700 K	220 lm	39,95 €



accessories

872127	power supply 12V DC 4,0 W	13,95 €
862232	power supply 12V DC 20,0 W	26,95 €
862240	power supply dimmable 12V DC 2,5 - 25,0 W	64,95 €



FINE II BUNDLE OF 3

- 3 x furniture surface-mounted luminaire FINE II 687035
- dimensions L x W x H: 190 x 60 x 5 mm
- 1 x DEKO-LIGHT power supply 862169
- dimmable via phase control or phase cut-off
- incl. 6-fold AMP distributor [extension up to 6 luminaires]

item	colour	colour temperature	light current	price
620014	grey	2700 K	3x 220 lm	199,95 €

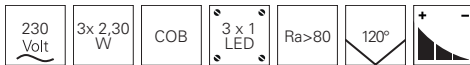

suitable pre-assembled accessories for extending the cabling on page 789



FINE II BUNDLE OF 5

- 5 x furniture surface-mounted luminaire FINE II 687035
- dimensions L x W x H: 190 x 60 x 5 mm
- 1 x DEKO-LIGHT power supply 862169
- dimmable via phase control or phase cut-off
- incl. 6-fold AMP distributor [extension up to 6 luminaires]

item	colour	colour temperature	light current	price
620015	grey	2700 K	5x 220 lm	296,95 €

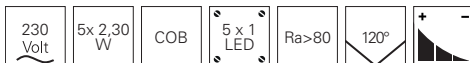

suitable pre-assembled accessories for extending the cabling on page 789

SPIEGEL ROUND

- aluminium
- dimensions L x H x Ø: 97 x 14 x 80 mm
- socket L x W: 30 x 15 mm
- dimmable via optional power supply



item	colour	colour temperature	light current	price
687130	silver coloured chrome	4000 K	300 lm	54,95 €

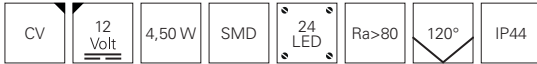

accessories

872629	power supply 12V DC 6,0 W	18,95 €
862232	power supply 12V DC 20,0 W	26,95 €
862240	power supply dimmable 12V DC 2,5 - 25,0 W	64,95 €



ROUND BUNDLE OF 3

- 3 x furniture surface-mounted luminaire ROUND 687130
- dimensions L x H x Ø: 97 x 14 x 80 mm
- 1 x DEKO-LIGHT power supply 862169
- dimmable via phase control or phase cut-off
- incl. 6-fold AMP distributor [extension up to 6 luminaires]

item	colour	colour temperature	light current	price
620016	silver coloured chrome	4000 K	3x 300 lm	219,95 €



suitable pre-assembled accessories for extending the cabling on page 789



ROUND BUNDLE OF 5

- 5 x furniture surface-mounted luminaire ROUND 687130
- dimensions L x H x Ø: 97 x 14 x 80 mm
- 1 x DEKO-LIGHT power supply 862169
- dimmable via phase control or phase cut-off
- incl. 6-fold AMP distributor [extension up to 6 luminaires]

item	colour	colour temperature	light current	price
620017	silver coloured chrome	4000 K	5x 300 lm	314,95 €



suitable pre-assembled accessories for extending the cabling on page 789

SPIEGEL ANGULAR

- aluminium
- dimensions L x W x H: 98 x 80 x 14 mm
- socket L x W: 30 x 15 mm
- dimmable via optional power supply



item	colour	colour temperature	light current	price
687131	silver coloured chrome	4000 K	300 lm	54,95 €

CV	12 Volt	4,50 W	SMD	24 LED	Ra>80	120°	IP44
----	---------	--------	-----	--------	-------	------	------

accessories

872629	power supply 12V DC 6,0 W	18,95 €
862232	power supply 12V DC 20,0 W	26,95 €
862240	power supply dimmable 12V DC 2,5 - 25,0 W	64,95 €



ANGULAR BUNDLE OF 3

- 3 x furniture surface-mounted luminaire ANGULAR 687131
- dimensions L x W x H: 98x 80 x 14 mm
- 1 x DEKO-LIGHT power supply 862169
- dimmable via phase control or phase cut-off
- incl. 6-fold AMP distributor [extension up to 6 luminaires]

item	colour	colour temperature	light current	price
620018	silver coloured chrome	4000 K	3x 300 lm	219,95 €

230 Volt	3x 4,50 W	SMD	3 x 24 LED	Ra>80	120°		IP44
----------	-----------	-----	------------	-------	------	--	------

suitable pre-assembled accessories for extending the cabling on page 789



ANGULAR BUNDLE OF 5

- 5 x furniture surface-mounted luminaire ANGULAR 687131
- dimensions L x W x H: 98 x 80 x 14 mm
- 1 x DEKO-LIGHT power supply 862169
- dimmable via phase control or phase cut-off
- incl. 6-fold AMP distributor [extension up to 6 luminaires]

item	colour	colour temperature	light current	price
620019	silver coloured chrome	4000 K	5x 300 lm	314,95 €

230 Volt	5x 4,50 W	SMD	5 x 24 LED	Ra>80	120°		IP44
----------	-----------	-----	------------	-------	------	--	------

suitable pre-assembled accessories for extending the cabling on page 789

SPIEGEL LINE

Reflections in the most beautiful light: the LINE I and LINE II luminaires distribute their warm white light over a large area and without shading on mirrors up to 10 mm thick. If required, the LINE series can also be used as an elegant surface-mounted luminaire for various pieces of furniture using the adapter supplied.



SPIEGEL LINE I

- aluminium
- dimensions L x W x H: 312 x 100 x 67 mm
- socket L x W x H: 100 x 60 x 67 mm
- dimmable via optional power supply
- incl. multi functional fixation
max. 10 mm deep [mirror, mounting]

item	colour	colour temperature	light current	price
687065	silver coloured chrome	3000 K	380 lm	75,95 €



accessories

872632	power supply 12V DC 12,0 W	22,95 €
862232	power supply 12V DC 20,0 W	26,95 €
862240	power supply dimmable 12V DC 2,5 - 25,0 W	64,95 €



LINE I BUNDLE OF 2

- 2 x furniture surface-mounted luminaire LINE I 687065
- dimensions L x W x H: 312 x 100 x 67 mm
- 1 x DEKO-LIGHT power supply 862170
- dimmable via phase control or phase cut-off
- incl. 6-fold AMP distributor [extension up to 6 luminaires]

item	colour	colour temperature	light current	price
620020	silver coloured chrome	3000 K	2x 380 lm	229,95 €



suitable pre-assembled accessories for extending the cabling on page 789



SPIEGEL LINE II

- aluminium
- dimensions L x W x H: 512 x 100 x 67 mm
- socket L x W x H: 100 x 60 x 67 mm
- dimmable via optional power supply
- incl. multi functional fixation
max. 10 mm deep [mirror, mounting]

item	colour	colour temperature	light current	price
687063	<input type="checkbox"/> silver coloured chrome	3000 K	550 lm	96,95 €

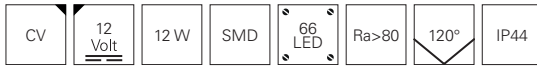

accessories

872632	power supply 12V DC 12,0 W	22,95 €
862232	power supply 12V DC 20,0 W	26,95 €
862240	power supply dimmable 12V DC 2,5 - 25,0 W	64,95 €



LINE II BUNDLE OF 2

- 2 x furniture surface-mounted luminaire LINE II 687063
- dimensions L x W x H: 512 x 100 x 67 mm
- 1 x DEKO-LIGHT power supply 862170
- dimmable via phase control or phase cut-off
- incl. 6-fold AMP distributor [extension up to 6 luminaires]

item	colour	colour temperature	light current	price
620021	<input type="checkbox"/> silver coloured chrome	3000 K	2x 550 lm	249,95 €



suitable pre-assembled accessories for extending the cabling on page 789



LUCY II

- aluminium
- dimensions L x W x H x Ø: 325 x 185 x 40 x 12 mm
- socket B: 35 mm
- dimmable via optional power supply

item	colour	colour temperature	light current	price
688003	grey	3000 K	400 lm	42,95 €

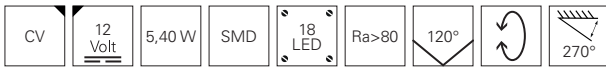

accessories

872632	power supply 12V DC 12,0 W	22,95 €
862232	power supply 12V DC 20,0 W	26,95 €
862240	power supply dimmable 12V DC 2,5 - 25,0 W	64,95 €

QUADRO POINT

- stainless steel
- dimensions L x W x H: 70 x 70 x 6,5 mm

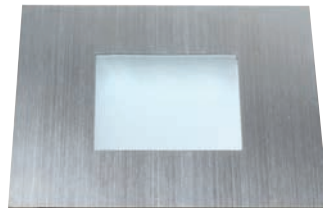

item	colour	colour temperature	light current	price
686940	silver coloured brushed	4500 K	30 lm	39,95 €



accessories

872127	power supply 12V DC 4,0 W	13,95 €
---------------	-------------------------------	----------------



LUCKYLITE PRO - BATTERY POWERED

- plastic
- dimensions L x W x H: 100,0 x 10,6 x 70,0 mm
- motion sensor

item	colour	colour temperature	price
687095	 silver coloured	 4000 K	54,95 €

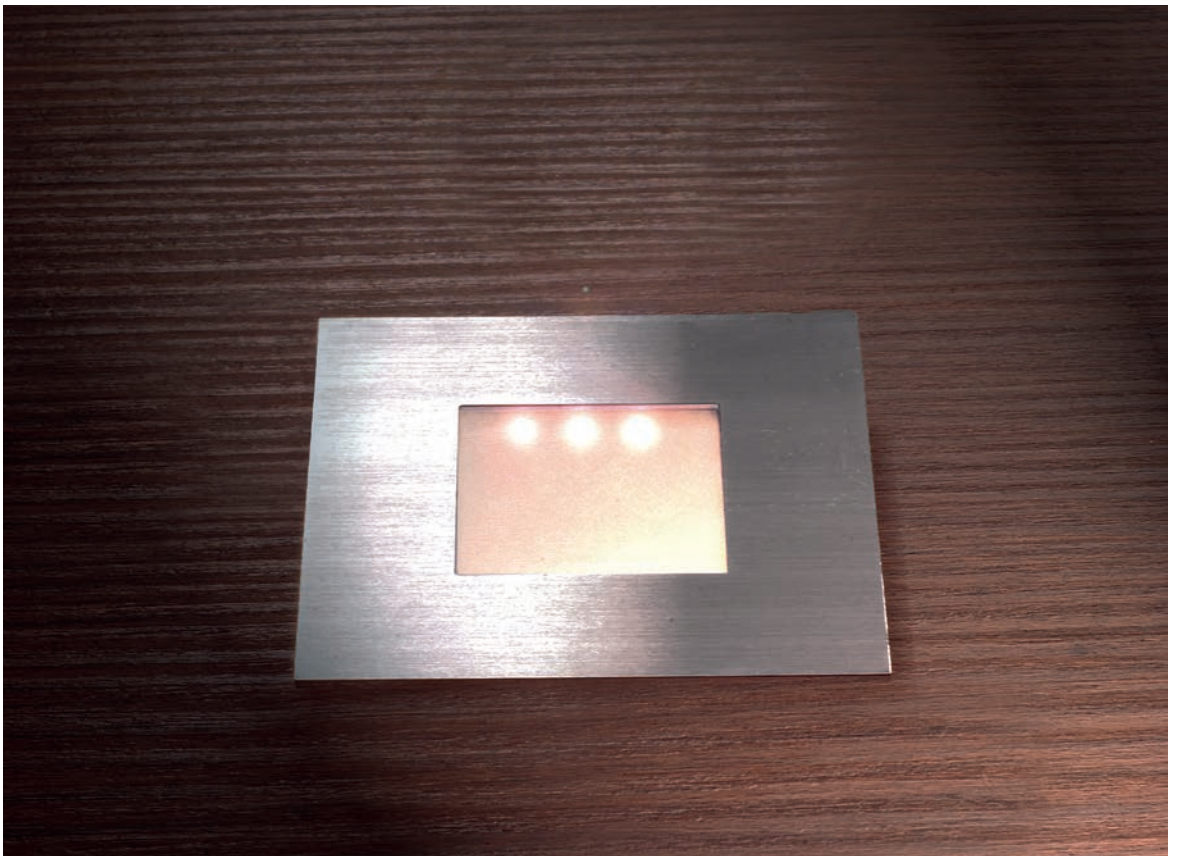
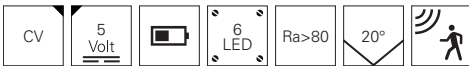



page 239



page 240



page 240



page 242



page 242

showcase lights



HERCULIS

Small helpers, big effect. With HERCULIS display luminaires in high-quality aluminium housings, you can reach all corners of a showcase. The luminaire head with its 40° beam angle can be freely rotated and swivelled in any direction. In addition, the intelligent cable routing and the ready-to-plugin system allow easy surface and recessed mounting in showcases, counters, sales areas or in the living room.



HERCULIS MAGNETIC

- design optimised for cabinets and showcases
- high performance despite compact design
- ready-to-plug-in system
- rotatable and swivelling head
- flexible mounting thanks to magnets
- aluminium diecast
- dimensions L x Ø: 42 x 31 mm
- socket H x Ø: 5 x 31 mm



item	colour	colour temperature	light current	price
688026	silver coloured	3000 K	100 lm	57,95 €
688025	black	3000 K	100 lm	57,95 €
688028	silver coloured	4000 K	105 lm	57,95 €
688027	black	4000 K	105 lm	57,95 €



accessories

930594	power supply, ready to plug in incl. 3-way distributor	25,95 €
930592	power supply, ready to plug in incl. 6-way distributor	35,95 €

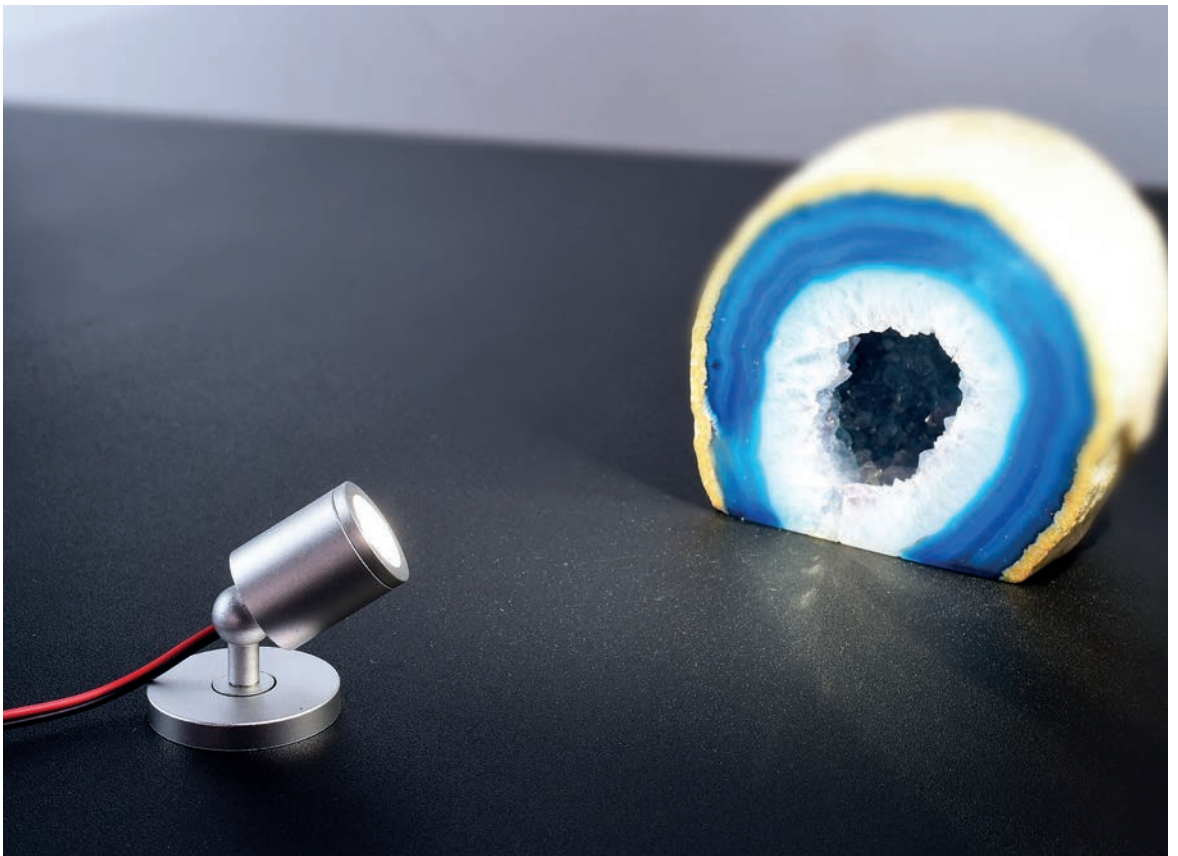

HERCULIS SMALL

- design optimised for cabinets and showcases
- high performance despite compact design
- for surface and recessed mounting thanks to intelligent cable routing
- ready-to-plug-in system
- rotatable and swivelling head
- aluminium diecast
- dimensions L x Ø: 150 x 39 mm
- socket H x Ø: 5 x 39 mm

item	colour	colour temperature	light current	price
688030	silver coloured	3000 K	100 lm	79,95 €
688029	black	3000 K	100 lm	79,95 €
688033	silver coloured	4000 K	100 lm	79,95 €
688031	black	4000 K	100 lm	79,95 €

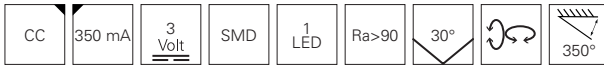

accessories

930594	power supply, ready to plug in incl. 3-way distributor	25,95 €
930592	power supply, ready to plug in incl. 6-way distributor	35,95 €



HERCULIS BIG

- design optimised for cabinets and showcases
- high performance despite compact design
- for surface and recessed mounting thanks to intelligent cable routing
- ready-to-plug-in system
- rotatable and swivelling head
- aluminium diecast
- dimensions L x Ø: 250 x 39 mm
- socket H x Ø: 5 x 39 mm

item	colour	colour temperature	light current	price
688035	silver coloured	3000 K	100 lm	79,95 €
688034	black	3000 K	100 lm	79,95 €
688037	silver coloured	4000 K	100 lm	79,95 €
688036	black	4000 K	100 lm	79,95 €



accessories

930594	power supply, ready to plug in incl. 3-way distributor	25,95 €
930592	power supply, ready to plug in incl. 6-way distributor	35,95 €





HERCULIS DOUBLE

- design optimised for cabinets and showcases
- high performance despite compact design
- for surface and recessed mounting thanks to intelligent cable routing
- ready-to-plug-in system
- rotatable and swivelling head
- aluminium diecast
- dimensions L x Ø: 200 x 39 mm
- socket H x Ø: 5 x 39 mm

item	colour	colour temperature	light current	price
688039	silver coloured	3000 K	185 lm	115,95 €
688038	black	3000 K	185 lm	115,95 €
688041	silver coloured	4000 K	195 lm	115,95 €
688040	black	4000 K	195 lm	115,95 €



accessories

930594	power supply, ready to plug in incl. 3-way distributor	25,95 €
930592	power supply, ready to plug in incl. 6-way distributor	35,95 €



HERCULIS TRIPLE

- design optimised for cabinets and showcases
- high performance despite compact design
- for surface and recessed mounting thanks to intelligent cable routing
- ready-to-plug-in system
- rotatable and swivelling head
- aluminium diecast
- dimensions L x Ø: 250 x 39 mm
- socket H x Ø: 5 x 39 mm

item	colour	colour temperature	light current	price
688043	silver coloured	3000 K	263 lm	135,95 €
688042	black	3000 K	263 lm	135,95 €
688045	silver coloured	4000 K	290 lm	135,95 €
688044	black	4000 K	290 lm	135,95 €

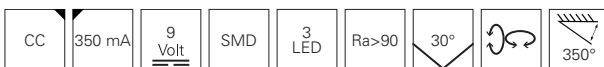

accessories

930594	power supply, ready to plug in incl. 3-way distributor	25,95 €
930592	power supply, ready to plug in incl. 6-way distributor	35,95 €







□ □ ■ □
page 247



□ □ ■ □
page 249



□ □
page 251



■ □ □
page 252



□ □ ■
page 253



□ □ ■
page 255



□ □
page 257



□
page 259



□
page 261



□ □ ■
page 263



■
page 265

office lights

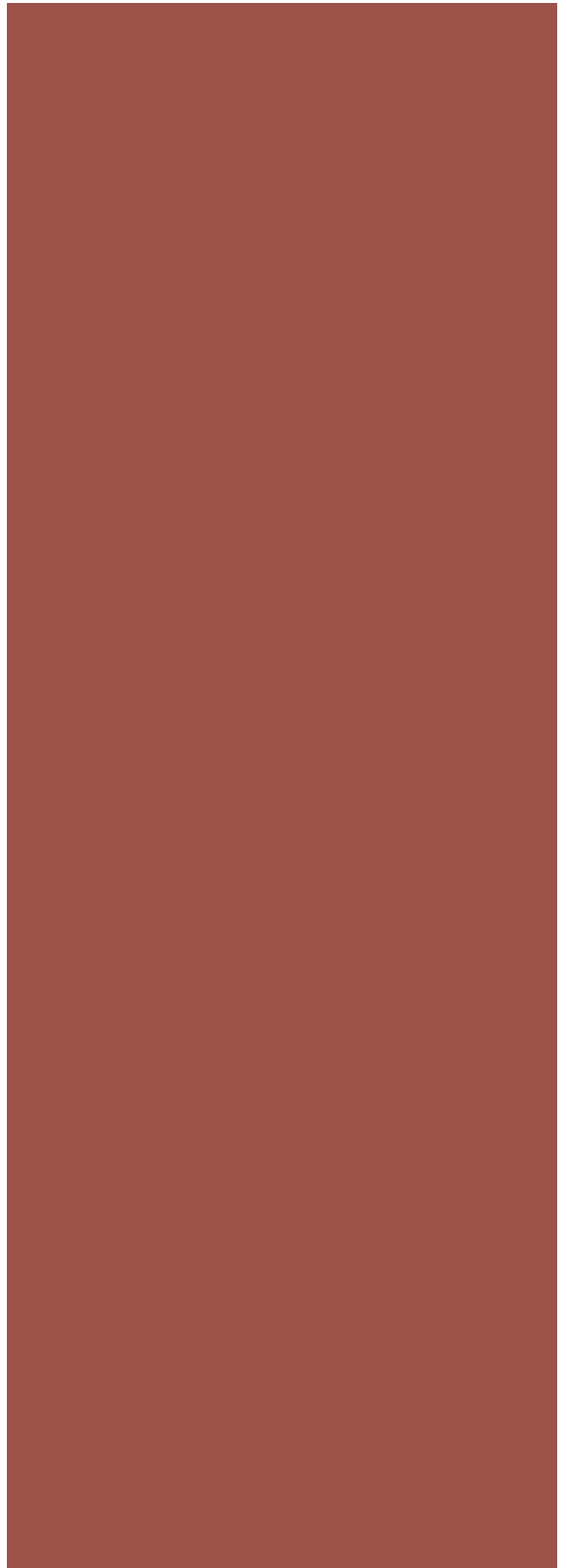



D PROFESSION DOWN

Thanks to their flexible control options, you can use the D PROFESSION pendant luminaires in both private and commercial applications. In the private sector, the dimmable down version creates a great lighting mood that harmonises perfectly with its modern design.



D PROFESSION DOWN

- powerful light output
- UGR <19
- ideal for home office or dining / living area
- aluminium
- dimensions L x W x H: 1177 x 53 x 53 mm
- socket L x W x H: 560 x 65 x 38 mm
- max. suspension: 3000 mm

item	colour	colour temperature	light current	control	price
620107	white	4000 K	3165 lm	phase control or phase cut-off	359,95 €
620110	silver coloured	4000 K	3165 lm	phase control or phase cut-off	359,95 €
620103	black	4000 K	3165 lm	phase control or phase cut-off	359,95 €
620106	white	4000 K	3165 lm	1-10V	369,95 €
620109	silver coloured	4000 K	3165 lm	1-10V	369,95 €
620102	black	4000 K	3165 lm	1-10V	369,95 €
620105	white	4000 K	3165 lm	DALI Bus according to IEC62386 DALI 1	389,95 €
620108	silver coloured	4000 K	3165 lm	DALI Bus according to IEC62386 DALI 1	389,95 €
620057	black	4000 K	3165 lm	DALI Bus according to IEC62386 DALI 1	389,95 €

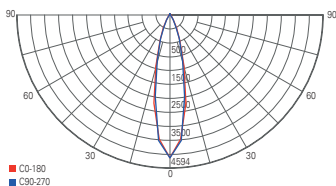
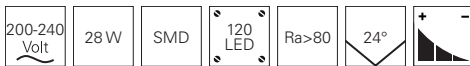

light distribution curve



D PROFESSION UP AND DOWN

Thanks to their flexible control options, you can use the D PROFESSION pendant luminaires in both private and commercial applications. The UP and Down version emits its light in two directions. While the upward LEDs create a pleasant, indirect room light, the downward LEDs provide a defined, powerful and UGR-compliant office and task light for desks and more.



D PROFESSION UP AND DOWN

- powerful light output
- UGR <19
- ideal for home office or dining / living area
- aluminium
- dimensions L x W x H: 1177 x 53 x 53 mm
- socket L x W x H: 560 x 65 x 38 mm
- max. suspension: 3000 mm

item	colour	colour temperature	light current	control	price
620111	white	4000 K	7180 lm	phase control or phase cut-off	429,95 €
620104	silver coloured	4000 K	7180 lm	phase control or phase cut-off	429,95 €
620112	black	4000 K	7180 lm	phase control or phase cut-off	429,95 €
620114	white	4000 K	7180 lm	1-10V	429,95 €
620113	silver coloured	4000 K	7180 lm	1-10V	429,95 €
620115	black	4000 K	7180 lm	1-10V	429,95 €
620117	white	4000 K	7180 lm	DALI Bus according to IEC62386 DALI 1	459,95 €
620116	silver coloured	4000 K	7180 lm	DALI Bus according to IEC62386 DALI 1	459,95 €
620118	black	4000 K	7180 lm	DALI Bus according to IEC62386 DALI 1	459,95 €

200-240 Volt

60 W

SMD

240 LED

Ra>80

110°/24°

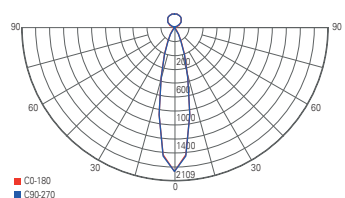

light distribution curve



OFFICE THREE DALI 2.0

The pendant luminaire is a matching addition to the OFFICE THREE MOTION floor lamp. As the glare value is less than 10, this technically sophisticated luminaire can almost be described as completely glare-free. The upward-facing LEDs create ambient light, while the downward-facing LEDs shine clearly defined and powerful light onto the work area.



OFFICE THREE DALI 2.0

- aluminium
- dimensions L x W x H: 1179 x 64 x 35 mm
- socket L x W x H: 600 x 57 x 35 mm
- max. suspension: 2500 mm
- UGR<10
- dimmable via DALI Bus according to IEC62386 DALI 2.0

item	colour	colour temperature	light current	price
342147	<input type="checkbox"/> white	<input type="checkbox"/> 4000 K	7000 lm	589,95 €
342146	<input type="checkbox"/> aluminium	<input type="checkbox"/> 4000 K	7000 lm	589,95 €



suitable
floor lights
page 263
343024
343023

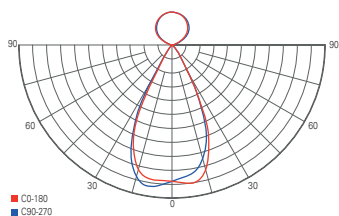

light distribution curve

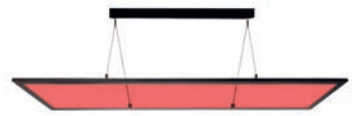
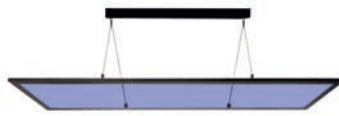
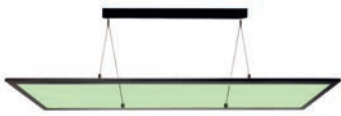
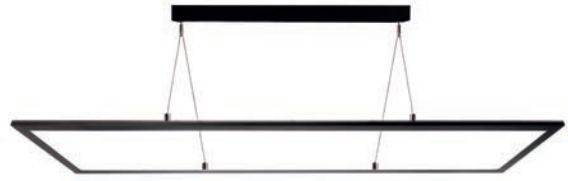

LED EVENT-PANEL TRANSPARENT RGBW

- aluminium
- dimensions L x W x H: 1195 x 295 x 14 mm
- dimmable via optional controller

item	colour	colour temperature	light current	price
342158	■ black clear / transparent	RGB WW 4000 K	4220 lm	279,95 €
620032	□ white clear / transparent	RGB WW 4000 K	4265 lm	279,95 €
620031	■ black clear / transparent	RGB WW 4000 K	4265 lm	279,95 €

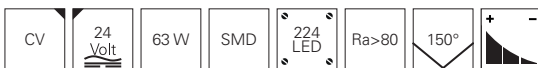

optionales accessories

862164	power supply 24V DC 75,0 W	82,95 €
843059	RF controller Set RGB+White 12/24/48V	119,95 €
843010	DALI LED PWM dimmer 4 channel	129,95 €
843000	DMX controller Art-4	229,95 €
843269	DMX dimmer OLED dimmer 4	124,95 €
843053	Quasar PWM-easy	149,95 €

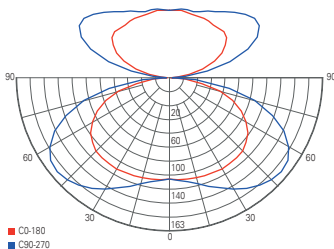

light distribution curve

LED PANEL TRANSPARENT ROUND

The special feature of this pendant luminaire is the transparent light body. When switched off, the surface is almost completely transparent. When the light is switched on, the disc distributes the light almost glare-free. With a glare value [UGR] of less than 19, this pendant luminaire is absolutely suitable for office use. Bright, efficient and with an extraordinary design, this luminaire stands out in any office setting.



LED PANEL TRANSPARENT ROUND

- aluminium
- dimensions H x Ø: 12,50 x 580 mm
- socket H x Ø: 45,00 x 250 mm
- max. suspension: 1500 mm
- UGR <19
- dimmable via phase control or phase cut-off
- almost transparent when switched off

item	colour	colour temperature	light current	price
342091	<input type="checkbox"/> white	3000 K	5100 lm	379,95 €
342094	<input type="checkbox"/> white	4000 K	5600 lm	379,95 €
342090	<input type="checkbox"/> aluminium	3000 K	5100 lm	379,95 €
342093	<input type="checkbox"/> aluminium	4000 K	5600 lm	379,95 €
342089	<input type="checkbox"/> black	3000 K	5100 lm	379,95 €
342092	<input type="checkbox"/> black	4000 K	5600 lm	379,95 €



suitable
floor light
page 259
343022

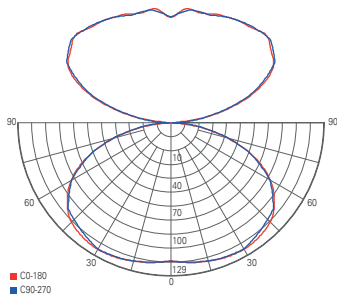

light distribution curve



LED PANEL TRANSPARENT

The LED pendant luminaire has a transparent glass for direct and indirect light distribution, which is almost transparent when switched off. When the light is switched on, the glass distributes the light almost glare-free. With a glare value [UGR] of less than 19, this pendant luminaire is absolutely suitable for office use. Bright, efficient and with an extraordinary design, this luminaire not only stands out in any office setting.



LED PANEL TRANSPARENT

- aluminium
- dimensions L x W x H: 1195 x 295 x 12 mm
- socket L x W x H: 580 x 80 x 40 mm
- max. suspension: 1800 mm
- UGR <19
- dimmable via phase control or phase cut-off
- almost transparent when switched off
- panel designed to IP40

item	colour	colour temperature	light current	price
342221	<input type="checkbox"/> white	3000/4000 K	5600/6100 lm	349,95 €
342220	<input type="checkbox"/> aluminium	3000/4000 K	5600/6100 lm	349,95 €
342219	<input type="checkbox"/> black	3000/4000 K	5600/6100 lm	319,95 €



suitable
floor light
page 259
343022



motion sensor
and daylight sensor

MOTION SENSOR

- the luminaire switches on automatically when there is movement
- without movement, the brightness is reduced to 30% after 30 min
- without movement, the luminaire switches off after 30 min.

DAYLIGHT SENSOR

- switch on the luminaire and dim it to the desired brightness dim [this setting is saved by the daylight sensor as the saves this setting as default]
- if the ambient light changes, the sensor adjusts the brightness to the stored standard [10% tolerance]





touch dimmer



OFFICE ONE + MOTION

- UGR<19
- SDCM <3
- service life 50.000h L80B10
- aluminium
- dimensions L x W x H: 1950 x 310 x 30 mm
- socket L x W: 460 x 300 mm
- gap size socket: 100 mm
- dimmable via touch sensor
- incl. 1,5 m connection cable with connector and device connector C21

item	colour	colour temperature	light current	sensor system	price
343034	aluminium	3000 K	6700 lm		819,95 €
343030	aluminium	4000 K	7400 lm		819,95 €
343035	aluminium	3000 K	6700 lm	motion and daylight sensor	949,95 €
343032	aluminium	4000 K	7400 lm	motion and daylight sensor	949,95 €

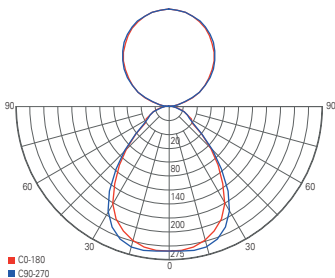

light distribution curve





touch dimmer



OFFICE ONE TRANSPARENT

- UGR<19
- service life 50.000h L80B10
- aluminium
- dimensions L x W x H: 1950 x 310 x 20 mm
- socket L x W: 460 x 30 mm
- dimmable via touch sensor
- almost transparent when switched off
- incl. 2,5 m connection cable with connector

item	colour	colour temperature	light current	price
343022	aluminium	4000 K	6200 lm	819,95 €



suitable
pendant lights
page 255
342221
342220
342219

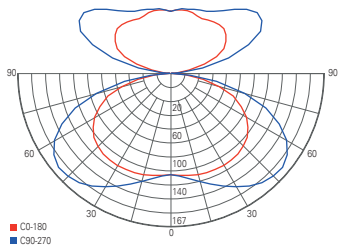

light distribution curve





rotary switch



OFFICE TWO

- UGR<19
- SDCM <3
- service life 50.000h L80B10
- aluminium
- dimensions L x W x H: 1950 x 310 x 42 mm
- socket L x W: 450 x 270 mm
- dimmable via rotary switch
- incl. 2,5 m connection cable with mains plug

item	colour	colour temperature	light current	price
343016	aluminium	4000 K	8300 lm	749,95 €

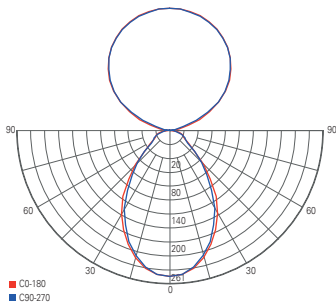
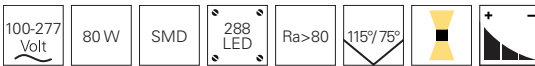

light distribution curve

OFFICE THREE MOTION

A modern floor luminaire for office spaces with modern control technology. When movement is detected, the minimalist luminaire switches on automatically. In addition, the OFFICE THREE MOTION adapts to the existing daylight conditions and regulates the brightness for relaxed working even over longer periods of time. The motion detector and the daylight sensor can be deactivated separately from each other. The direct and indirect light components can be controlled separately. The luminaire is particularly glare-free thanks to UGR<6 and ideal for illuminating individual workstations.



motion sensor
and daylight sensor

MOTION SENSOR

- the luminaire switches on automatically when there is movement
- without movement, the brightness is reduced to 30% after 30 min
- without movement, the luminaire switches off after 30 min.

DAYLIGHT SENSOR

- switch on the luminaire and dim it to the desired brightness dim [this setting is saved by the daylight sensor as the saves this setting as default]
- if the ambient light changes, the sensor adjusts the brightness to the stored standard [10% tolerance]





touch panel



suitable
pendant lights
page 251
342147
342146

OFFICE THREE MOTION

- UGR<6
- SDCM <3
- service life 50.000h L80B10
- optimal for single workstations
- aluminium
- dimensions L x W x H: 1950 x 64 x 1056 mm
- socket L x W: 500 x 225 mm
- gap size socket: 100 mm
- direct and indirect light
separately dimmable and switchable via touch panel
- motion sensor
- daylight sensor
- incl. 2,5 m connection cable with connector

item	colour	colour temperature	light current	price
343024	white	NW 4000 K	9600 lm	1.099,95 €
343023	aluminium	NW 4000 K	9600 lm	1.099,95 €
343033	black	NW 4000 K	9600 lm	1.099,95 €

110-240 Volt

80 W

156 LED

Ra>80

50°

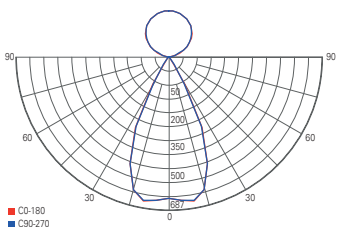

light distribution curve



OFFICE THREE MOTION CCT

The OFFICE THREE MOTION is our bestseller for stylish office lighting – and now even more versatile. The new OFFICE THREE MOTION CCT now not only controls the brightness depending on the existing daylight conditions, but also the light colour in the range of 3,000 to 5,700 K [CCT: Correlated Colour Temperature]. In addition to the integrated motion and daylight sensors, the modern free-standing luminaire also has a touch panel for selecting the lighting modes [up, down, up and down]. This way, you can work even more relaxed – even over longer periods of time.

new



touch panel

OFFICE THREE MOTION CCT

- UGR<6
- SDCM <3
- service life 50.000h L80B10
- optimal for single workstations
- aluminium
- dimensions L x W x H: 1950 x 64 x 1056 mm
- socket L x W: 500 x 225 mm
- gap size socket: 100 mm
- light color adjustable via touch panel
- direct and indirect light
separately dimmable and switchable via touch panel
- motion sensor
- daylight sensor
- incl. 2,5 m connection cable with connector



item	colour	colour temperature	light current	price
343036	■ black	■ ww ■ cw 3000-5700 K	8700 lm	1.249,95 €

110-240 Volt	80 W	528 LED	Ra>80	50°	■	+
--------------	------	---------	-------	-----	---	---

suitable
pendant lights
page 251
342147
342146

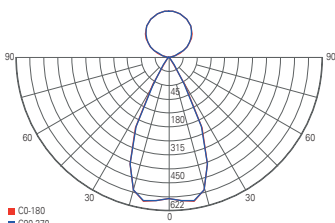

light distribution curve



page 269



page 271

hall floodlight





ALUDRA

Whether in high-bay warehouses, large sales areas or spacious presentation areas – the pendant luminaires of the ALUDRA series present themselves as universal highbay luminaires for use at great heights. Thanks to their high luminous intensity, wide beam angle and IK10 impact resistance class, the ALUDRA luminaires provide functional lighting for large areas safely and reliably.



ALUDRA

- high luminous intensity
- optimum illumination for e.g. warehouses or sales areas
- aluminium
- incl. 3 m connection cable
- DALI Bus according to IEC62386 DALI 2 [only for item number 732141 & 732142]

item	colour	colour temperature	light current	dimensions H x Ø	power	control	price
732138	■ black	cw 5000 K	15030 lm	153 x 360 mm	100 W		299,95 €
732139	■ black	cw 5000 K	24450 lm	165 x 360 mm	160 W		359,95 €
732140	■ black	cw 5000 K	30300 lm	178 x 405 mm	200 W		439,95 €
732141	■ black	cw 5000 K	15415 lm	153 x 360 mm	100 W	DALI Bus	359,95 €
732142	■ black	cw 5000 K	29315 lm	178 x 405 mm	200 W	DALI Bus	529,95 €

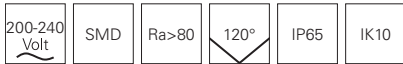

accessories for **732138, 732139, 732141**

930590	reflector 60°, black	64,95 €
930641	suspension set 1m chain	14,95 €
930685	suspension set 3m chain	24,95 €
930686	wall mounting arm	42,95 €



accessories for **732140, 732142**

930642	reflector 60°, black	84,95 €
930641	suspension set 1m chain	14,95 €
930685	suspension set 3m chain	24,95 €
930687	wall mounting arm	43,95 €

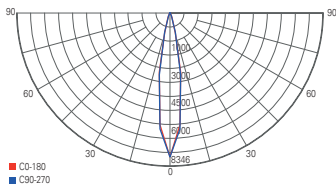

light distribution curve 732138

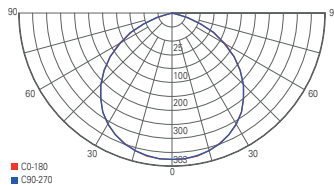

light distribution curve 732139

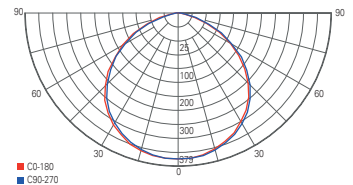

light distribution curve 732140

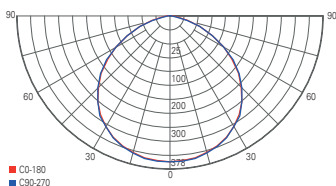

light distribution curve 732141

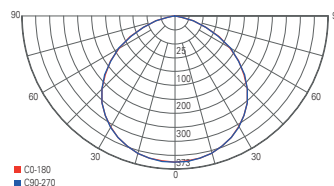

light distribution curve 732142



HIGHBAY NORMAE

The energy-efficient Highbay spotlights are ideal for hall lighting. Thanks to the adjustable mounting set, the spotlights can be mounted at the desired angle of inclination. With the corresponding set, there is also the option of suspending them and, if required, equipping them with asymmetrical lenses.



HIGHBAY NORMAE

- aluminium diecast
- socket L x W x H: 110 x 70 x 95 mm
- DALI Bus according to IEC62386 DALI 1.0
- incl. verstellbarem Befestigungsset

item	colour	colour temperature	light current	dimensions L x W x H	power	light source	price
732084	■ dunkelgrau	■ cw 5000 K	16700 lm	923 x 126 x 99 mm	136 W	192 LED	399,95 €
732085	■ dunkelgrau	■ cw 5000 K	23800 lm	1219 x 126 x 99 mm	172 W	236 LED	499,95 €



accessories

- 930295** linear Highbase lens 30°/70° 290 x 86 x 8 mm **27,95 €**
930293 suspension set 1m chain **39,95 €**

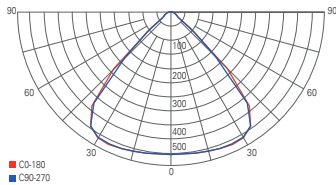
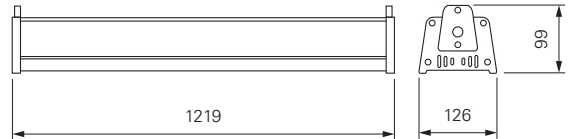
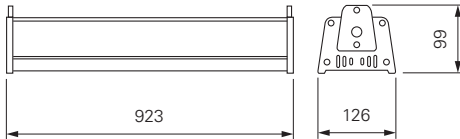

light distribution curve 732084 mit Linse 90°

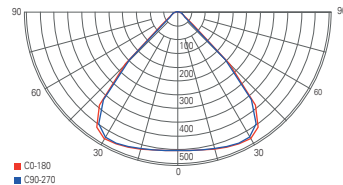

light distribution curve 732085 mit Linse 90°

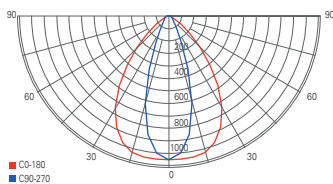

light distribution curve 732084 mit Linse 30°/70°

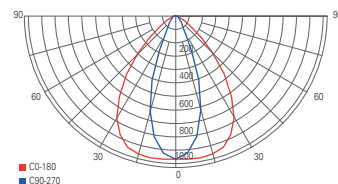

light distribution curve 732085 mit Linse 30°/70°



□ □
page 275



□ □
page 277



□ □
page 278



□ ■ ■
page 279



□ ■ ■
page 279

damp-proof luminaires





With the kind support of WIBU-SYSTEMS AG Karlsruhe

TRI PROOF SLIM

Waterproof, impact-resistant and versatile – the surface-mounted ceiling luminaires of the TRI PROOF SLIM series are flexible workhorses with an innovative design. Whether in wet areas, cellars, workshops, garages or warehouses – the IP68-certified SLIMS are impact-resistant up to IK10 and their beam angle can be continuously adjusted.



TRI PROOF SLIM

- robust plastic housing
- light direction continuously selectable by turning
- easy installation in existing fixings [e.g. pipe clamps]
- simple connection due to screwless terminals
- simple through-wiring
- incl. 4x screws, 4x dowels, 2x bracket clip, 2x quick connection clip, 1x cable connection cap

item	colour	colour temperature	light current	dimensions L x Ø	power	price
348138	<input type="checkbox"/> white	<input checked="" type="checkbox"/> cw 5000 K	2265 lm	700 x 39 mm	21 W	94,95 €
348139	<input type="checkbox"/> white	<input checked="" type="checkbox"/> cw 5000 K	4575 lm	1300 x 39 mm	40 W	139,95 €



through-wiring

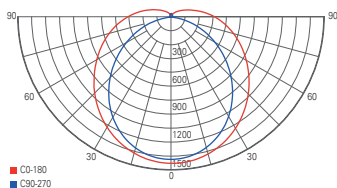

light distribution curve 348138

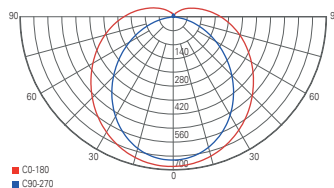

light distribution curve 348139



TRI PROOF

Equipped with LEDs in neutral white light colour [4000 K], the TRIPROOF LED IP65 moisture-proof luminaire consists of a light grey polycarbonate housing and a satinised polycarbonate cover in one piece. It is suitable for simple ceiling, wall or pendant mounting and is available in three different lengths.

Several can be strung together; ideal for industrial and private use, e.g. for lighting under canopies, in basements, workshops, garages, industrial halls, etc. The luminaire is provided with a simple electrical connection with plug-in terminal.





TRI PROOF

- robust plastic housing
- stackable up to 25 [730419] / 15 [730424] / 10 [730425] piece
- incl. mountings clips

item	colour	colour temperature	light current	dimensions L x W x H	power	price
730419	<input type="checkbox"/> white	4000 K	1430 lm	696 x 61 x 56 mm	16,80 W	49,95 €
730424	<input type="checkbox"/> white	4000 K	2980 lm	1296 x 61 x 56 mm	34,40 W	75,95 €
730425	<input type="checkbox"/> white	4000 K	3820 lm	1598 x 61 x 56 mm	43,60 W	83,95 €

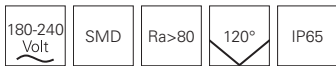

accessories

930071 wire suspension 2 pcs. | L: 2500 mm

14,95 €

930072 mounting fixation 2 pcs.

14,95 €

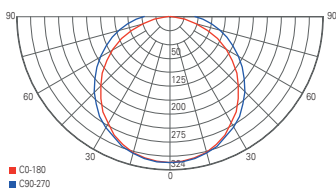

light distribution curve 730419

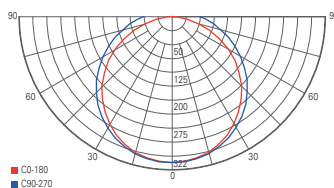

light distribution curve 730424

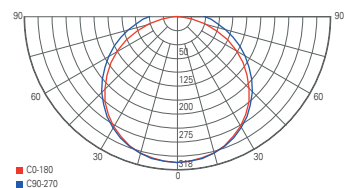

light distribution curve 730425

TRI PROOF MOTION

The ideal luminaire for environments with increased lighting requirements: whether in the garage, in the cellar or for the carport – the surface-mounted TRI PROOF MOTION luminaire is protected against wind and weather thanks to IP65 certification and is of course equipped with an integrated, invisible motion sensor that can be adjusted via dip switch.



TRI PROOF MOTION

- robust plastic housing
- motion sensor
- incl. mountings clips

item	colour	colour temperature	light current	dimensions L x W x H	power	price
730450	<input type="checkbox"/> white	<input checked="" type="checkbox"/> NW 4000 K	1900 lm	61 x 56 x 665 mm	18 W	59,95 €
730455	<input type="checkbox"/> white	<input checked="" type="checkbox"/> NW 4000 K	2500 lm	61 x 56 x 1145 mm	24 W	69,95 €



accessories

930071	wire suspension 2 pcs. L: 2500 mm	14,93 €
930072	mounting fixation 2 pcs.	14,93 €

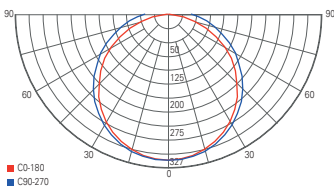

light distribution curve 730450

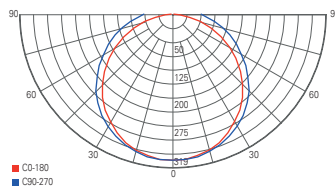

light distribution curve 730455



SYRMA OVAL

- plastic
- dimensions L x W x H: 180 x 125 x 105 mm
- socket L x W x H: 155 x 125 x 35 mm

item	colour	price
401011	<input type="checkbox"/> white	9,95 €
401013	<input type="checkbox"/> grey	9,95 €
401012	<input type="checkbox"/> black	9,95 €



suitable illuminants on page 770-771



SYRMA ROUND

- plastic
- dimensions H x Ø: 110 x 190 mm
- socket H x Ø: 35 x 160 mm

item	colour	price
401014	<input type="checkbox"/> white	13,95 €
401016	<input type="checkbox"/> grey	13,95 €
401015	<input type="checkbox"/> black	13,95 €



suitable illuminants on page 770-771



□ □
page 282



□
page 282



□ □
page 283



□ □
from page 284



□ □
from page 286

emergency lights



EMERGENCY LIGHT ALMAAZ CONE

- plastic
- dimensions L x W x H: 283 x 50 x 187 mm
- single battery technology with LiFePO4 battery
- detection range 27m
- SK II / III with INSiLIA technology
- luminance 500cd/m²
- autotest function with buzzer
- rotatable housing for ceiling or wall mounting
- incl. changeable pictogram set in all directions



item	colour	colour temperature	price
348152	<input type="checkbox"/> white	NW 4500 K	199,95 €



optional accessories

930632	special pictogram First Aid Box green	119,95 €
930633	special pictogram fire extinguisher red	119,95 €
930634	battery bar 3,2V 1500mAh	59,95 €



EMERGENCY LIGHT ALSAFI

- plastic
- dimensions L x W x H: 360 x 88 x 118 mm
- single battery technology with LiFePO4 battery
- detection range 16m
- SK II / III with INSiLIA technology
- luminance 500cd/m²
- autotest function with buzzer
- cut-outs for pendant mounting
- reflector with hinges
- suitable for ceiling or wall mounting
- incl. changeable pictogram set in all directions



item	colour	colour temperature	price
348140	<input type="checkbox"/> white	NW 4500 K	189,95 €



optional accessories

930634	battery bar 3,2V 1500mAh	42,95 €
---------------	------------------------------	----------------

EMERGENCY LIGHT ALMAAZ FLAT

- plastic
- dimensions L x W x H: 283 x 50 x 198 mm
- single battery technology with LiFePO4 battery
- detection range 27m
- SK II / III with INSILIA technology
- DIP switch for switching from 3 to 8h
- luminance 500cd/m²
- autotest function with buzzer
- rotatable housing for ceiling or wall mounting
- incl. changeable pictogram set in all directions



item	colour	colour temperature	price
348151	<input type="checkbox"/> white	<input checked="" type="checkbox"/> 4500 K	289,95 €

 230 Volt	 3 W	 IP54
--	---	--

optional accessories

930632	special pictogram First Aid Box green	119,95 €
930633	special pictogram fire extinguisher red	119,95 €
930634	battery bar 3,2V 1500mAh	59,95 €



With the kind support of WIBU-SYSTEMS AG Karlsruhe

EMERGENCY LIGHT ALMACH FOR THE ILLUMINATION OF CORRIDORS

- Red Dot Award Winner 2017
- special lens for the illumination of escape routes or for area lighting
- plastic
- dimensions L x W x H: 192 x 101 x 57 mm
- single battery technology with LiFePO4 battery
- SK II / III with INSiLIA technology
- 3h/8h bridging time
- simple click mounting
- rotatable



item	colour	colour temperature	price
731142	<input type="checkbox"/> white	NW 4500 K	269,95 €



PHOTOMETRIC DATA

mounting height	a		b		c		d		c		d	
	1 W	2 W	1 W	2 W	1 W	2 W	1 W	2 W	1 W	2 W	1 W	2 W
2,5 m	3,50	3,92	7,84	8,84	2,72	3,03	6,05	7,00	5,02	5,77	11,54	13,46
3,0 m	3,78	4,37	9,09	9,82	3,05	3,52	6,79	7,83	5,55	6,33	12,65	14,60
3,5 m	3,97	4,93	9,85	11,04	3,33	3,83	7,66	8,52	5,98	7,07	14,15	16,26
4,0 m	3,81	5,24	10,48	12,16	3,56	4,09	8,18	9,41	6,32	7,75	15,50	17,74
4,5 m	-	5,50	10,99	13,19	3,73	4,45	8,90	10,24	6,12	8,37	16,74	19,09
5,0 m	-	5,50	11,00	14,14	3,87	4,62	9,56	11,00	-	8,57	-	20,30
5,5 m	-	-	-	15,00	-	4,91	-	11,69	-	8,72	-	21,39
6,0 m	-	-	-	15,23	-	5,17	-	12,32	-	8,82	-	22,38
6,5 m	-	-	-	15,37	-	5,41	-	12,90	-	8,56	-	23,27
7,0 m	-	-	-	15,99	-	5,43	-	13,42	-	-	-	-
7,5 m	-	-	-	15,98	-	5,61	-	13,89	-	-	-	-

EMERGENCY LIGHT ALMACH FOR THE ILLUMINATION OF AREAS

- Red Dot Award Winner 2017
- special lens for the illumination of escape routes or for area lighting
- plastic
- dimensions L x W x H: 192 x 101 x 57 mm
- single battery technology with LiFePO4 battery
- SK II / III with INSILIA technology
- 3h/8h bridging time
- simple click mounting
- rotatable



item	colour	colour temperature	price
731143	<input type="checkbox"/> white	<input checked="" type="checkbox"/> 4500 K	269,95 €

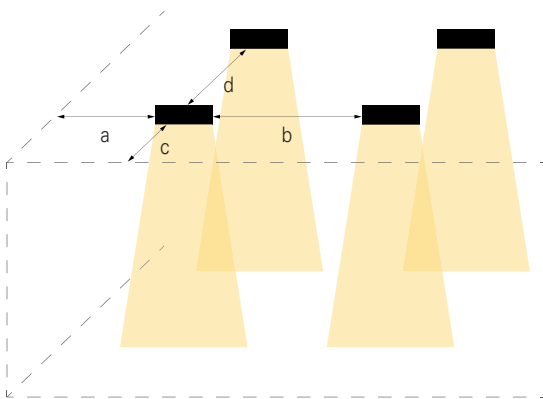

- a: distance from luminaire [narrow page] to wall
 b: distance from luminaire [narrow page] to luminaire [narrow page]
 c: distance from luminaire [long page] to wall
 d: distance from luminaire [long page] to luminaire [long page]

EMERGENCY LIGHT ALNAIR FOR THE ILLUMINATION OF AREAS

- special lens for the illumination of escape routes or for area lighting
- plastic
- dimensions H x Ø: 28 x 78 mm
- single battery technology with LiFePO4 battery
- SK II / III with INSiLIA technology
- 3h/8h bridging time



item	colour	colour temperature	price
565326	<input type="checkbox"/> white	NW 4500 K	289,95 €

230 Volt	1 W	68	IP42
----------	-----	----	------

PHOTOMETRIC DATA

mounting height	a		b		c		d		c		d	
	1 W	2 W	1 W	2 W	1 W	2 W	1 W	2 W	1 W	2 W	1 W	2 W
2,5 m	3,57	4,00	8,00	9,02	2,68	3,09	6,17	7,14	5,13	5,62	11,78	13,74
3,0 m	3,84	4,45	9,24	9,99	3,11	3,45	6,90	7,96	5,64	6,43	12,87	14,85
3,5 m	3,89	5,00	10,00	11,20	3,38	3,89	7,77	8,64	6,06	7,18	14,35	15,72
4,0 m	3,73	5,13	10,62	12,32	3,48	4,14	8,28	9,53	6,16	7,85	15,70	17,16
4,5 m	2,00	5,56	11,11	13,34	3,78	4,50	9,00	10,35	-	8,12	-	19,30
5,0 m	1,92	5,55	11,11	14,28	3,91	4,66	9,66	11,11	-	8,66	-	20,50
5,5 m	-	5,50	-	14,60	-	4,95	-	11,80	-	8,80	-	21,59
6,0 m	-	-	-	-	-	-	-	-	-	-	-	-
6,5 m	-	-	-	-	-	-	-	-	-	-	-	-
7,0 m	-	-	-	-	-	-	-	-	-	-	-	-
7,5 m	-	-	-	-	-	-	-	-	-	-	-	-

EMERGENCY LIGHT ALNAIR FOR THE ILLUMINATION OF CORRIDORS

- special lens for the illumination of escape routes or for area lighting
- plastic
- dimensions H x Ø: 28 x 78 mm
- single battery technology with LiFePO4 battery
- SK II / III with INSILIA technology
- 3h/8h bridging time



item	colour	colour temperature	price
565325	<input type="checkbox"/> white	<input checked="" type="checkbox"/> nw 4500 K	289,95 €

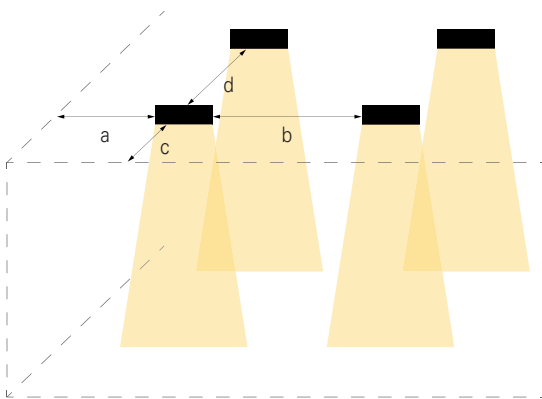

- a: distance from luminaire [narrow page] to wall
 b: distance from luminaire [narrow page] to luminaire [narrow page]
 c: distance from luminaire [long page] to wall
 d: distance from luminaire [long page] to luminaire [long page]



POWER RAILS

290 D LINE power rail system

318 power luminaires



□ ■ ■ □
page 299



□ □
page 299



□ ■ ■
page 300



□ ■ ■
page 301



□ ■ ■
page 301



□ ■ ■
page 302



□ ■ ■
page 302



□ ■ ■
page 303



□ ■ ■
page 303



□ ■ ■
page 304



□ ■ ■
page 305



□ ■ ■
page 306



□ ■
page 307



□ ■ ■
page 307



□ ■ ■
page 308



□ ■ ■
page 308



□ ■ ■
page 309



□ ■ ■
page 309



□ ■ ■
page 310



□ ■ ■
page 310



■
page 311



□
page 311



□ ■ ■
page 313



□ ■ ■
page 314



□ ■
page 315



□ ■
page 316



□ ■ ■
page 316



□ ■ ■
page 317

D LINE power rail system

D LINE MOUNTING POWER RAIL SYSTEM 3-PHASE 230V

mounting modules	illust.	white	grey	black	page
mounting power rail L: 1000 mm	01	710000	710001	710002	299
mounting power rail L: 2000 mm	01	710003	710004	710005	299
mounting power rail L: 3000 mm	01	710006	710007	710008	299
mounting adapter for lights	02	710045	710046	710047	300
live end feeder left	03	710009	710010	710011	301
live end feeder right side	04	710012	710013	710014	301
electrical straight connector with center feed option	05	710042	710043	710044	302
flexible-connector left-right side	06	710039	710040	710041	302
electrical joint	07	710015	710016	710017	303
mechanical joint	08	710018	710019	710020	303
90°-joint left-right with exchange mechanism	09	710036	710037	710038	304
T-joint left-left-right with exchange mechanism	10	710027	710028	710029	305
T-joint right-right-left with exchange mechanism	11	710030	710031	710032	305
X-joint left-left-right-right	12	710033	710034	710035	306
cover plate built in track	13	710077	-	710079	307
endcap	14	710066	710067	710068	307
ceiling mounting bracket flex	15	710063	710064	710065	308
suspension clamp for track connection	16	710057	710058	710059	308
ceiling suspension rigid [635 mm] with canopy	17	710078	710085	710084	309
extension for ceiling suspension [300 mm]	17	710086	710088	710087	309
wire suspension bracket with ceiling rosette 1500 mm	18	710048	710049	710050	310
rope suspension bracket Mini mit Abhängeseil 5000 mm	19	710094	710095	710096	310
quick mounting bracket for grid ceilings	20	710051	710052	710053	313
truss adapter silver coloured	21	-	710083	-	311
quick mounting clamp for exhibition stand construction	22	-	-	710082	311
3-circuits adapter for light installation	23	710097	710098	710099	314
3-circuits adapter with Multi CC power supply 250/350/450/500 mA 6,30 - 21,00 W 25-42V	24	862180	-	862183	315
3-circuits adapter with Multi CC power supply 600/700/750/800 mA 15,00 - 33,60 W 25-42V	24	862181	-	862184	315
3-circuits adapter with Multi CC power supply 850/900/950/1050 mA 23,00 - 44,10 W 27-42V	24	862182	-	862185	315
electrical outlet adapter	25	710024	-	710026	316
mounting adapter for additional components max. 10kg	26	710054	710055	710056	316
signs hook, max. load 5kg	27	710060	710061	710062	317

ILLUSTRATIONS WITH PLANNING RELEVANT DIMENSIONS

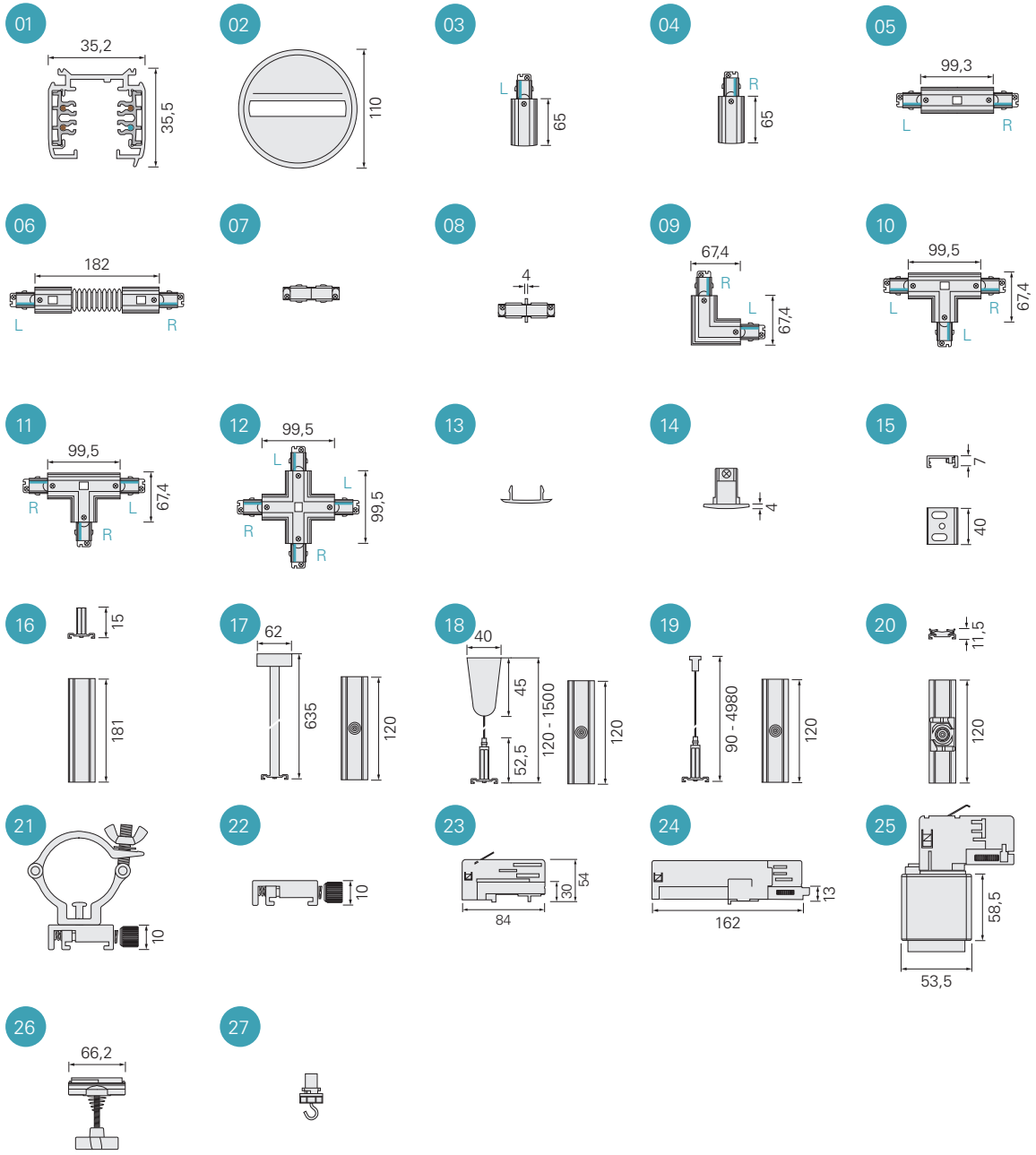

D LINE BUILT IN POWER RAIL SYSTEM 3-PHASE 230V

built in modules	illustr.	white	illustr.	cover	page
built in power rail L:1000 mm	01	710069		-	299
built in power rail L: 2000 mm	01	710070		-	299
built in power rail L: 3000 mm	01	710071		-	299
live end feeder left	02	710009	18	710089	301
live end feeder right side	03	710012	18	710089	301
electrical straight connector with center feed option	04	710042	19	710090	302
electrical joint	05	710015		-	303
mechanical joint	06	710018		-	303
90°-joint left-right	07	710036	20	710091	304
T-joint left-left-right	08	710027	21	710093	305
T-joint right-right-left	09	710030	21	710093	305
X-joint left-left-right-right	10	710033	22	710092	306
cover plate built in track	11	710077			307
endcap	12	710066		-	307
3-circuits adapter for light installation	13	710097		-	314
3-circuits adapter with Multi CC power supply 250/350/450/500 mA 6,30 - 21,00 W 25-42V	14	862180			315
3-circuits adapter with Multi CC power supply 600/700/750/800 mA 15,00 - 33,60 W 25-42V	14	862181			315
3-circuits adapter with Multi CC power supply 850/900/950/1050 mA 23,00 - 44,10 W 27-42V	14	862182			315
electrical outlet adapter	15	710024		-	316
mounting adapter for additional components max. 10kg	16	710054		-	316
signs hook, max. load 5kg	17	710060		-	317



Unlike other systems, you will not need any additional or special electrical components such as feeders, connectors, corners or T-connectors for the recessed tracks in the future. All standard components of the system are used and only the matching plastic cover is exchanged, and the recessed version is ready. This simplifies stock-keeping and gives significantly more flexibility here as well.

ILLUSTRATIONS WITH PLANNING RELEVANT DIMENSIONS

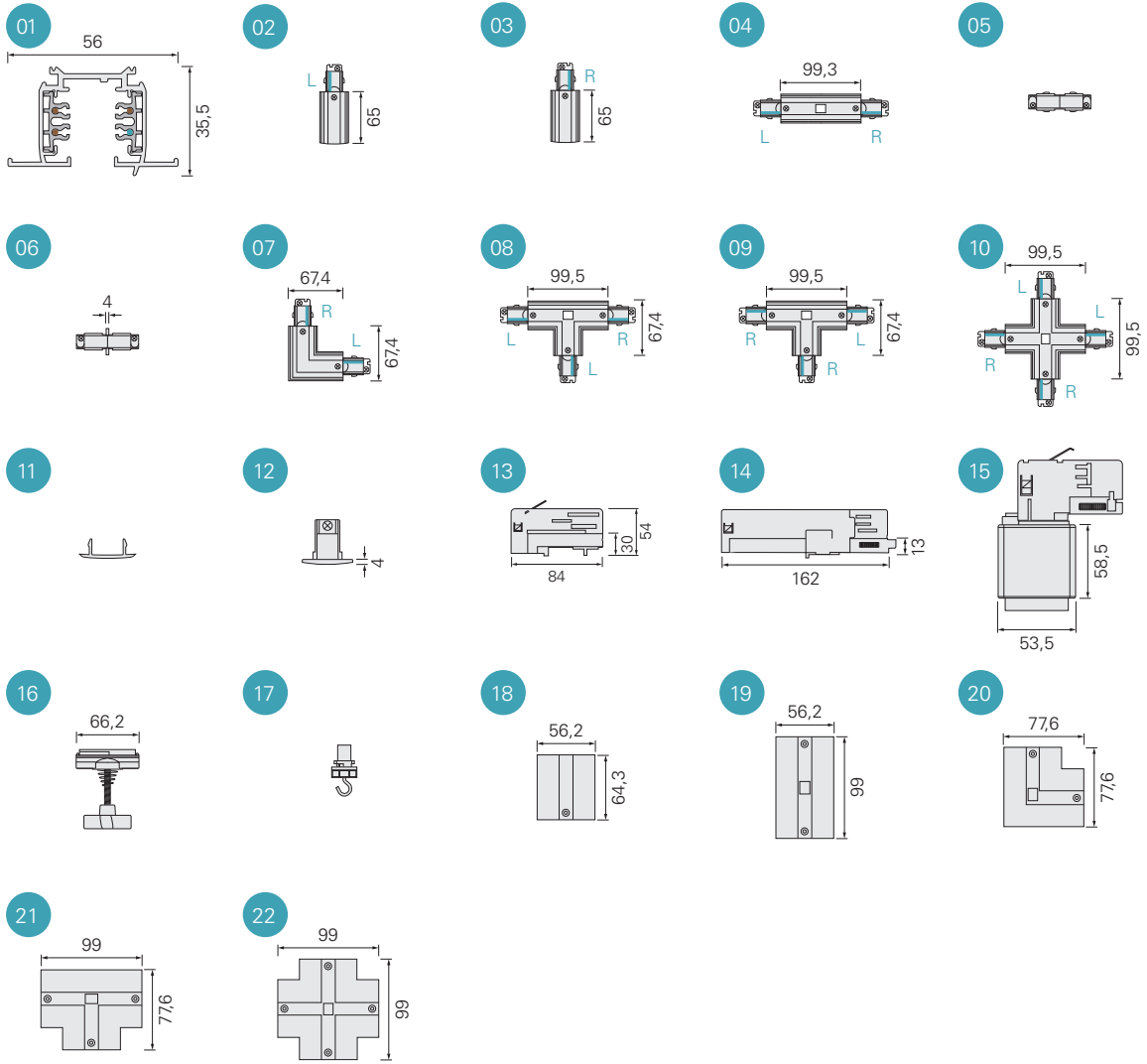

FIXING POINTS

power rail	a	b	c	d
1000 mm	125 mm			
2000 mm	125 mm	998 mm		
3000 mm	125 mm		914 mm	1167 mm

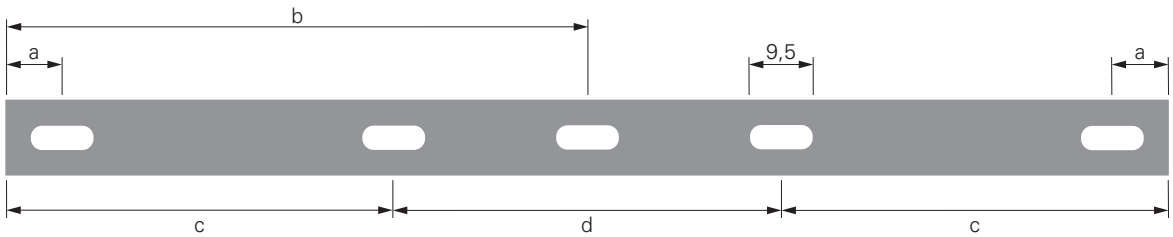

MECHANICAL LOAD TRACK POWER RAIL 1000 MM

50 N $\hat{=}$ 5,09 kg
dimension in mm

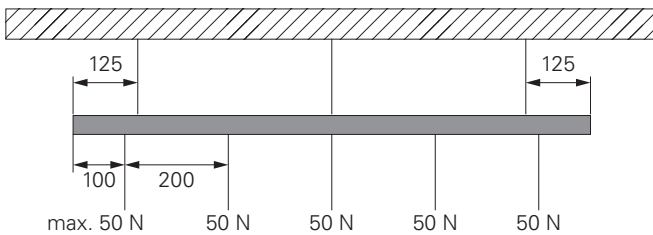

MECHANICAL LOAD TRACK POWER RAIL 2000/3000 MM

50 N $\hat{=}$ 5,09 kg
dimension in mm

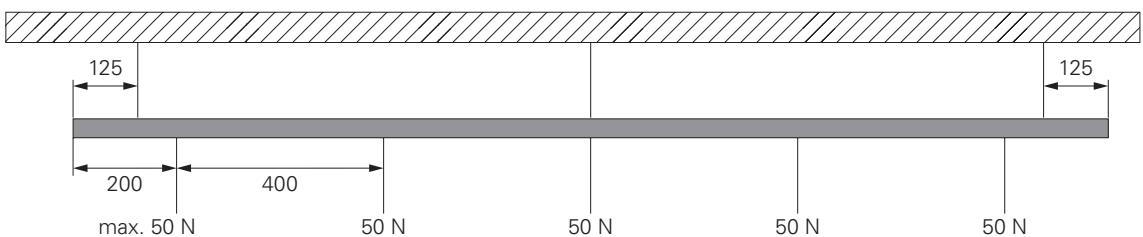

PLANNING GUIDE D LINE TRACK SYSTEM 3-PHASE 230V

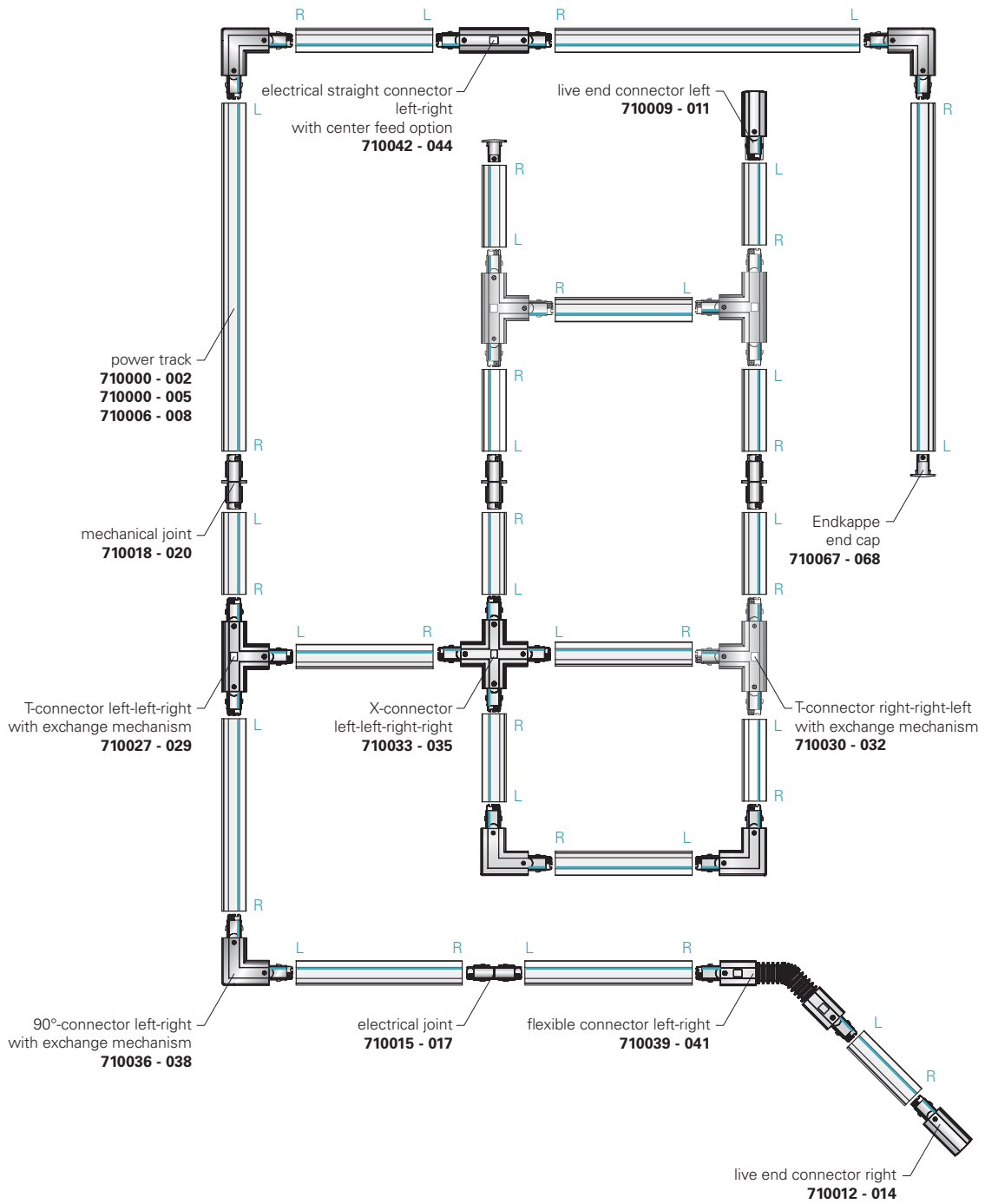
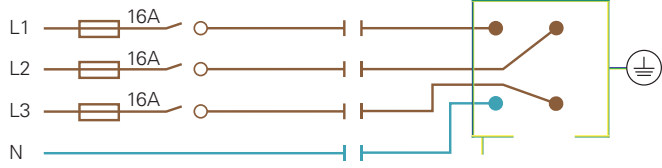
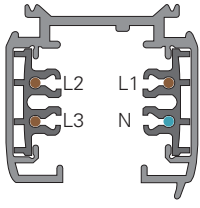

D LINE POWER RAIL SYSTEM 3-PHASE 230V

The new D LINE track system is available exclusively from DEKO-LIGHT and is extremely easy to plan and install thanks to its components, some of which have been completely redesigned. It is also compatible with all common track adapters and luminaires. The elegant and timeless design is available in white, black and grey, and the wide range

of accessories and mounting components means that there are no limits to its use and installation. Thanks to the new interchangeable mechanism of the 90° and T connectors, planning is easier than ever before and the installation of even complex shapes will be child's play in the future.

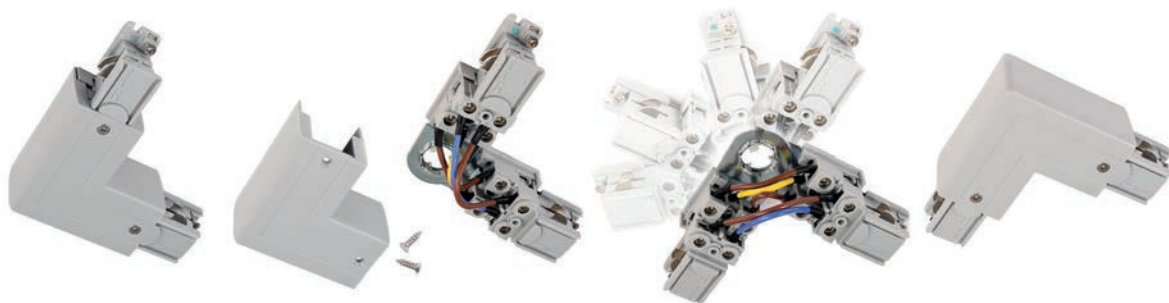

COMPATIBILITY OVERVIEW

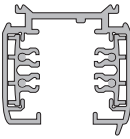
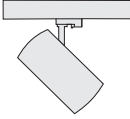
power rail D LINE	luminaires and power rail adapters from:						
	D LINE	Global	Ivela	Erco	Hoffmeister	Zumtobel/ Staff	Eutrac
	compatible	compatible	compatible	compatible	compatible	compatible	compatible
luminaires DEKO-LIGHT	3-phase power rail from:						
	D LINE	Global	Ivela	Erco	Hoffmeister	Zumtobel/ Staff	Eutrac
	compatible	compatible*	compatible*	compatible*	compatible*	compatible*	compatible*

*compatible with all DEKO-LIGHT 3-phase spotlights, except ALNITAK series [S. 323] and 3-phase adapter with integrated multi-CC power supply [S. 315].

All data without guarantee. Technical data and dimensions are subject to change without prior notice. Check against samples when planning a project to ensure functionality.



D LINE MOUNTING POWER RAIL

- aluminium
- 3-phase

item	colour	dimensions W x H x L	price
710000	<input type="checkbox"/> white	35,2 x 35,2 x 1000 mm	44,95 €
710003	<input type="checkbox"/> white	35,2 x 35,2 x 2000 mm	89,95 €
710006	<input type="checkbox"/> white	35,2 x 35,2 x 3000 mm	129,95 €
710001	<input type="checkbox"/> grey	35,2 x 35,2 x 1000 mm	44,95 €
710004	<input type="checkbox"/> grey	35,2 x 35,2 x 2000 mm	89,95 €
710007	<input type="checkbox"/> grey	35,2 x 35,2 x 3000 mm	129,95 €
710002	<input type="checkbox"/> black	35,2 x 35,2 x 1000 mm	44,95 €
710005	<input type="checkbox"/> black	35,2 x 35,2 x 2000 mm	89,95 €
710008	<input type="checkbox"/> black	35,2 x 35,2 x 3000 mm	129,95 €



D LINE BUILT IN POWER RAIL WITH WINGS

- aluminium
- 3-phase

item	colour	dimensions W x H x L	price
710069	<input type="checkbox"/> white	56 x 35,5 x 1000 mm	54,95 €
710070	<input type="checkbox"/> white	56 x 35,5 x 2000 mm	99,95 €
710071	<input type="checkbox"/> white	56 x 35,5 x 3000 mm	144,95 €



On request, all D LINE busbars can be supplied ready-made and cut to size according to your specifications for a small surcharge. This allows you to start installation directly on site at the customer's premises. Please contact our sales department for more information.



With the surface-mounted adapter, every 3-phase track luminaire can be converted into a surface-mounted spotlight. This is often desired when ceiling spots scattered around the room are to match the design of the track spotlights.



D LINE MOUNTING ADAPTER FOR LIGHTS

- plastic
- luminaire not included

item	colour	dimensions W x Ø	price
710045	<input type="checkbox"/> white	35 x 110 mm	29,95 €
710046	<input type="checkbox"/> grey	35 x 110 mm	29,95 €
710047	<input type="checkbox"/> black	35 x 110 mm	29,95 €





D LINE LIVE END FEEDER LEFT

- plastic
- suitable for mounting and built-in system
- up to 3-phases can be fed in

item	colour	dimensions L x W x H	price
710009	<input type="checkbox"/> white	98,5 x 35,2 x 35,5 mm	15,95 €
710010	<input type="checkbox"/> grey	98,5 x 35,2 x 35,5 mm	15,95 €
710011	<input type="checkbox"/> black	98,5 x 35,2 x 35,5 mm	15,95 €



accessories for built in system

710089 cover plate built in track feeder left/right **3,95 €**



D LINE LIVE END FEEDER RIGHT

- plastic
- suitable for mounting and built-in system
- up to 3-phases can be fed in

item	colour	dimensions L x W x H	price
710012	<input type="checkbox"/> white	98,5 x 35,2 x 35,5 mm	15,95 €
710013	<input type="checkbox"/> grey	98,5 x 35,2 x 35,5 mm	15,95 €
710014	<input type="checkbox"/> black	98,5 x 35,2 x 35,5 mm	15,95 €



accessories for built in system



710089 cover plate built in track feeder left/right **3,95 €**





D LINE ELECTRICAL STRAIGHT CONNECTOR WITH CENTER FEED OPTION

- plastic
- suitable for mounting and built-in system
- up to 3-phases can be fed in

item	colour	dimensions L x W x H	price
710042	 white	166 x 35 x 35,5 mm	32,95 €
710043	 grey	166 x 35 x 35,5 mm	32,95 €
710044	 black	166 x 35 x 35,5 mm	32,95 €





accessories for built in system

710090 cover plate built in track straight connector **3,95 €**



D LINE FLEXIBLE-CONNECTOR LEFT-RIGHT

- plastic
- suitable for mounting system

item	colour	dimensions L x W x H	price
710039	 white	248 x 35 x 35,5 mm	42,95 €
710040	 grey	248 x 35 x 35,5 mm	42,95 €
710041	 black	248 x 35 x 35,5 mm	42,95 €





D LINE ELECTRICAL JOINT

- plastic
- suitable for mounting and built-in system

item	colour	dimensions L x W x H	price
710015	<input type="checkbox"/> white	68 x 20,5 x 26,5 mm	9,95 €
710016	<input type="checkbox"/> grey	68 x 20,5 x 26,5 mm	9,95 €
710017	<input type="checkbox"/> black	68 x 20,5 x 26,5 mm	9,95 €



D LINE MECHANICAL JOINT

- plastic
- suitable for mounting and built-in system

item	colour	dimensions L x W x H	price
710018	<input type="checkbox"/> white	66,4 x 20 x 27 mm	6,95 €
710019	<input type="checkbox"/> grey	66,4 x 20 x 27 mm	6,95 €
710020	<input type="checkbox"/> black	66,4 x 20 x 27 mm	6,95 €





If, for example, more complex track installations are to be visually connected to one piece, but several different power supplies/controls are used, the mechanical connector is ideal. Visually, the track appears to be in one piece, electrically the two sections are separated from each other.



D LINE 90°-JOINT LEFT-RIGHT WITH EXCHANGE MECHANISM

- plastic
- suitable for mounting and built-in system

item	colour	dimensions L x W x H	price
710036	 white	100,7 x 100,7 x 35,5 mm	34,95 €
710037	 grey	100,7 x 100,7 x 35,5 mm	34,95 €
710038	 black	100,7 x 100,7 x 35,5 mm	34,95 €



accessories for built in system

710091 cover plate built in track 90°-joint **3,95 €**

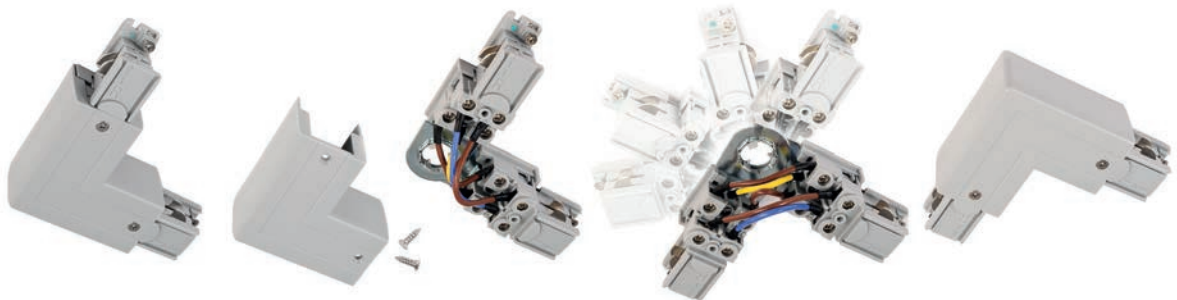

By simply removing the cover of the corner connector, the alignment [left/right] can be reversed. This eliminates the annoying rethinking [N conductor left or right] and makes both planning and installation child's play.

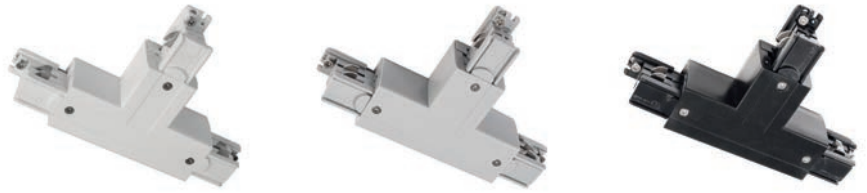

D LINE T-JOINT LEFT-LEFT-RIGHT WITH EXCHANGE MECHANISM

- plastic
- suitable for mounting and built-in system

item	colour	dimensions L x W x H	price
710027	white	166 x 101 x 35,5 mm	49,95 €
710028	grey	166 x 101 x 35,5 mm	49,95 €
710029	black	166 x 101 x 35,5 mm	49,95 €



D LINE T-JOINT RIGHT-RIGHT-LEFT WITH EXCHANGE MECHANISM

- plastic
- suitable for mounting and built-in system

item	colour	dimensions L x W x H	price
710030	white	166 x 101 x 35,5 mm	49,95 €
710031	grey	166 x 101 x 35,5 mm	49,95 €
710032	black	166 x 101 x 35,5 mm	49,95 €



accessories for built in system

710093	cover plate built in track T-joint	3,95 €
---------------	------------------------------------	---------------

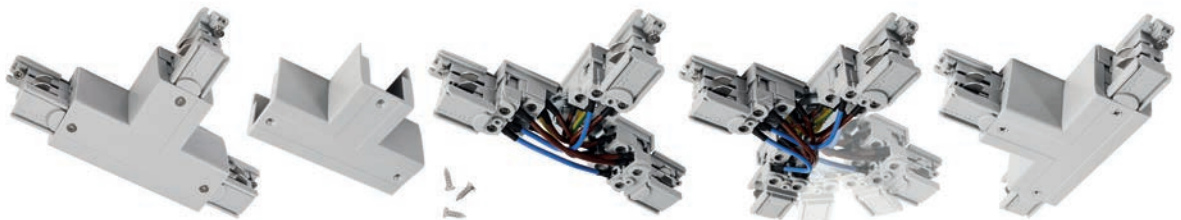

Almost identically to the corner connector, the direction [left/right] of the T-joint can also be changed by removing the cover. Due to the design, however, there are two T-joints in each colour variant, as it may be that either left/left/right or right/right/left is required depending on the alignment.

But also with this article, the variants could be reduced by half. This also means here: significantly simplified planning and assembly.

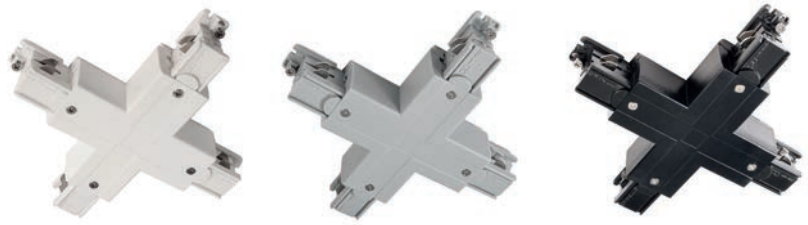

D LINE X-JOINT LEFT-LEFT-RIGHT-RIGHT

- plastic
- suitable for mounting and built-in system

item	colour	dimensions L x W x H	price
710033	<input type="checkbox"/> white	166 x 166 x 35,5 mm	66,95 €
710034	<input type="checkbox"/> grey	166 x 166 x 35,5 mm	66,95 €
710035	<input type="checkbox"/> black	166 x 166 x 35,5 mm	66,95 €



accessories for built in system

710092 cover plate built in track X-joint **4,95 €**



With the kind support of WIBU-SYSTEMS AG Karlsruhe



D LINE COVER PLATE BUILT IN TRACK

- plastic
- suitable for mounting and built-in system

item	colour	dimensions L x W x H	price
710077	<input type="checkbox"/> white	1000 x 21,5 x 7,5 mm	5,95 €
710079	<input checked="" type="checkbox"/> black	1000 x 21,5 x 7,5 mm	5,95 €

Conductor rails mounted within a possible contact zone or at a height of less than 2.30 m must additionally be closed with a cover panel.



D LINE ENDCAP

- plastic
- suitable for mounting and built-in system

item	colour	dimensions L x W x H	price
710066	<input type="checkbox"/> white	31,3 x 35,2 x 32,5 mm	2,95 €
710067	<input checked="" type="checkbox"/> grey	31,3 x 35,2 x 32,5 mm	2,95 €
710068	<input checked="" type="checkbox"/> black	31,3 x 35,2 x 32,5 mm	2,95 €



D LINE MOUNTING BRACKET FLEX

- metal
- suitable for mounting system

item	colour	dimensions L x W x H	price
710063	white	40 x 33,8 x 12,5 mm	5,95 €
710064	grey	40 x 33,8 x 12,5 mm	5,95 €
710065	black	40 x 33,8 x 12,5 mm	5,95 €



D LINE SUSPENSION CLAMP FOR TRACK CONNECTION

- metal
- suitable for mounting system
- for chain assembly
[chain not included]

item	colour	dimensions L x W x H	price
710057	white	181 x 32 x 20 mm	9,95 €
710058	grey	181 x 32 x 20 mm	9,95 €
710059	black	181 x 32 x 20 mm	9,95 €



D LINE CEILING SUSPENSION RIGID

- metal
- stable and shapely suspension
- suspension dimension 635 mm [can be shortened to 335 mm]
- suspension dimension can be extended by means of accessories
- suitable for mounting system



item	colour	dimensions L x W	price
710078	<input type="checkbox"/> white	635 x 60 mm	32,95 €
710085	<input type="checkbox"/> grey	635 x 60 mm	32,95 €
710084	<input type="checkbox"/> black	635 x 60 mm	32,95 €



EXTENSION FOR CEILING SUSPENSION

- metal
- increases the suspension dimension by 300 mm each
- suitable for rigid ceiling suspension

item	colour	dimensions L x W	price
710086	<input type="checkbox"/> white	300 x 10 mm	5,95 €
710088	<input type="checkbox"/> grey	300 x 10 mm	5,95 €
710087	<input type="checkbox"/> black	300 x 10 mm	5,95 €



D LINE WIRE SUSPENSION BRACKET

- metal / plastic
- rope length: 1500 mm
- suspension dimension can be individually shortened: 120-1500 mm
- suitable for mounting system

item	colour	dimensions L x W x H	price
710048	white	120 x 31 x 52 mm	14,95 €
710049	grey	120 x 31 x 52 mm	14,95 €
710050	black	120 x 31 x 52 mm	14,95 €

accessories

710081	rope L: 4000 mm	7,95 €
---------------	-------------------	---------------

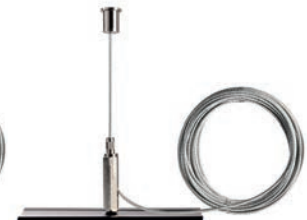
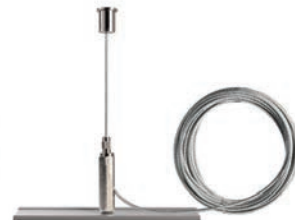

D LINE ROPE SUSPENSION BRACKET MINI

- metal
- beautifully shaped and filigree suspension
- rope length: 5000 mm
- suspension dimension can be individually shortened: 90 - 4980 mm
- suitable for mounting system

item	colour	dimensions L x W x H	price
710094	white	120 x 31 x 58 mm	19,95 €
710095	grey	120 x 31 x 58 mm	19,95 €
710096	black	120 x 31 x 58 mm	19,95 €





D LINE QUICK MOUNTING CLAMP FOR TRADE FAIR CONSTRUCTION

- aluminium
- suitable for mounting system

item	colour	dimensions L x W x H	price
710082	■ black	40 x 30 x 11,9 mm	10,95 €

Especially in trade fair construction, where busbars are frequently mounted and dismantled, the quick mounting clamp is the perfect mounting aid. The conductor rail is clicked into place with the spring clip and fixed in place without tools by means of a knurled screw. Conductor rail installation has never been faster.

D LINE TRUSS ADAPTER

- aluminium
- suitable for mounting system

item	colour	dimensions L x W x H	price
710083	□ silver coloured	40 x 30 x 11,9 mm	29,95 €

Thanks to the quick-release fasteners of the truss adapter, the D LINE busbars can be mounted in seconds on the trusses with 50 mm tube diameters commonly used in event technology and exhibition stand construction.





This little »jack-of-all-trades« makes mounting a track on an existing grid ceiling child's play. The installation time is only a fraction of what it used to be. In the first step, the clip is simply clicked into the visible metal strips of the grid ceiling and is held bomb-proof on the ceiling by means of a safety spring clip. After that, the conductor rail is simply pushed onto it and the installation is finished.





D LINE QUICK MOUNTING BRACKET FOR GRID CEILINGS

- metal
- suitable for mounting system

item	colour	dimensions L x W x H	price
710051	<input type="checkbox"/> white	120 x 31 x 11 mm	11,95 €
710052	<input type="checkbox"/> grey	120 x 31 x 11 mm	11,95 €
710053	<input type="checkbox"/> black	120 x 31 x 11 mm	11,95 €



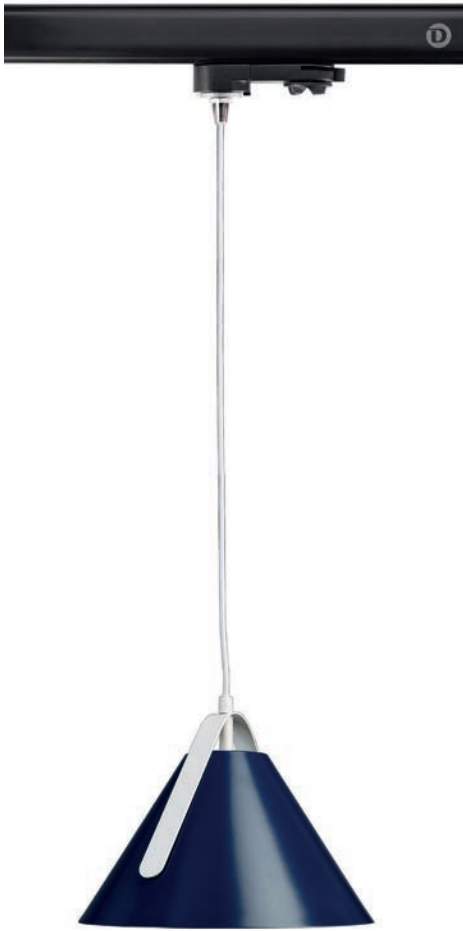

D LINE 3-PHASE-ADAPTER FOR LUMINAIRE MOUNTING

- plastic / metal
- max. 10 kg/100N
- suitable for mounting and built-in system
- delivery includes trumpet nipple and M10 flat nut and strain relief grommet
- luminaire not included

item	colour	dimensions L x W x H	price
710097	<input type="checkbox"/> white	84 x 32 x 54 mm	18,95 €
710098	<input type="checkbox"/> grey	84 x 32 x 54 mm	18,95 €
710099	<input type="checkbox"/> black	84 x 32 x 54 mm	18,95 €



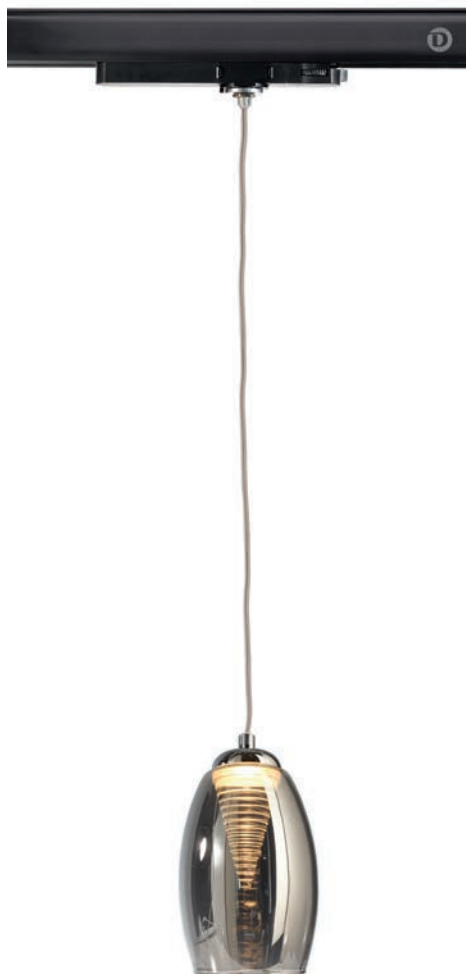

D LINE 3-PHASE-ADAPTER WITH MULTI CC POWER SUPPLY

- plastic / metal
- max. 10 kg/100N
- suitable for mounting and built-in system
- delivery includes trumpet nipple and M10 flat nut
- luminaire not included
- integrated, adjustable, current-stable power supply [CC]
- exclusively for 3-phase power rail from D LINE, Ivela and Hoffmeister
- it is essential to check suitability of the intended luminaire



item	colour	dimensions L x W x H				price
862180	<input type="checkbox"/> white	162 x 31 x 41 mm	250/350/450/500 mA	6,30 - 21,00 W	25-42V	32,95 €
862181	<input type="checkbox"/> white	162 x 31 x 41 mm	600/700/750/800 mA	15,00 - 33,60 W	25-42V	35,95 €
862182	<input type="checkbox"/> white	162 x 31 x 41 mm	850/900/950/1050 mA	23,00 - 44,10 W	27-42V	37,95 €
862183	<input checked="" type="checkbox"/> black	162 x 31 x 41 mm	250/350/450/500 mA	6,30 - 21,00 W	25-42V	32,95 €
862184	<input checked="" type="checkbox"/> black	162 x 31 x 41 mm	600/700/750/800 mA	15,00 - 33,60 W	25-42V	35,95 €
862185	<input checked="" type="checkbox"/> black	162 x 31 x 41 mm	850/900/950/1050 mA	23,00 - 44,10 W	27-42V	37,95 €





D LINE ELECTRICAL OUTLET ADAPTER

- plastic
- integrated fuse
- suitable for mounting and built-in system

item	colour	dimensions L x W x H	price
710024	white	58,5 x 53,5 x 103 mm	28,95 €
710026	black	58,5 x 53,5 x 103 mm	28,95 €



D LINE MOUNTING ADAPTER FOR ADDITIONAL COMPONENTS

- plastic / metal
- max. load 10 kg/100N
- suitable for mounting and built-in system

item	colour	dimensions L x W x H	price
710054	white	66,5 x 31,5 x 84 mm	10,95 €
710055	grey	66,5 x 31,5 x 84 mm	10,95 €
710056	black	66,5 x 31,5 x 84 mm	10,95 €



With our socket adapter, additional devices, lights etc. can be supplied with power in the simplest way. In combination with the »Mounting adapter for additional components« [710054/55/56], additional headlights or other devices [up to 10kg] can be attached and supplied with power.



D LINE SIGNS HOOK

- plastic / metal
- max. load 5 kg/50N
- suitable for mounting and built-in system

item	colour	dimensions H x Ø	price
710060	<input type="checkbox"/> white	52 x 25 mm	2,95 €
710061	<input type="checkbox"/> grey	52 x 25 mm	2,95 €
710062	<input type="checkbox"/> black	52 x 25 mm	2,95 €



□ ■
page 321



□ □
page 321



□ □
page 322



□ □ ■
page 323



□ □ ■ □
page 324



□ □ ■
page 325



□ ■ □
page 326



□ ■
page 327



□ □ ■
page 328



□ □ ■
page 329



□ □
page 330



□ □
page 331



□ ■ □
from page 332



□ ■ □
page 334



□ ■
page 335



□ ■
page 336



□ ■
page 337



power luminaires

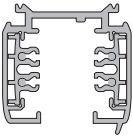

COMPATIBILITY OVERVIEW

power rail D LINE	luminaires and power rail adapters from:						
	D LINE	Global	Ivela	Erco	Hoffmeister	Zumtobel/ Staff	Eutrac
	compatible	compatible	compatible	compatible	compatible	compatible	compatible

luminaires DEKO-LIGHT	3-phase power rail from:						
	D LINE	Global	Ivela	Erco	Hoffmeister	Zumtobel/ Staff	Eutrac
	compatible	compatible*	compatible*	compatible*	compatible*	compatible*	compatible*

*compatible with all DEKO-LIGHT 3-phase spotlights, except ALNITAK series [S. 323] and 3-phase adapter with integrated multi-CC power supply [S. 315].

All data without guarantee. Technical data and dimensions are subject to change without prior notice. Check against samples when planning a project to ensure functionality.



With the kind support of SH-Lichttechnik / Becks Reutlingen



PANEL TRACK LIGHT

- aluminium
- dimensions L x W x H: 300 x 110 x 8,5 mm

item	colour	colour temperature	light current	price
707134	<input type="checkbox"/> white	3000 K	2000 lm	109,95 €
707136	<input type="checkbox"/> white	4000 K	2200 lm	109,95 €
707135	<input checked="" type="checkbox"/> black	3000 K	2000 lm	109,95 €
707137	<input checked="" type="checkbox"/> black	4000 K	2200 lm	109,95 €

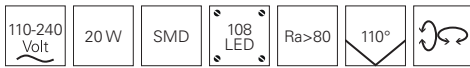

FLOOD SMD 15 + 30

- aluminium diecast, glass

suitable
floodlights
from page 510
732147-732155

item	colour	colour temperature	light current	dimensions L x W x H	socket L x W	power	light source	price
707130	<input type="checkbox"/> white	3000 K	1575 lm	192 x 180 x 38 mm	179 x 20 mm	15 W	36 LED	109,95 €
707138	<input type="checkbox"/> white	4000 K	1650 lm	192 x 180 x 38 mm	179 x 20 mm	15 W	36 LED	99,95 €
707139	<input type="checkbox"/> white	3000 K	3150 lm	261 x 236 x 41 mm	237 x 25 mm	30 W	72 LED	139,95 €
707140	<input type="checkbox"/> white	4000 K	3300 lm	261 x 236 x 41 mm	237 x 25 mm	30 W	72 LED	139,95 €

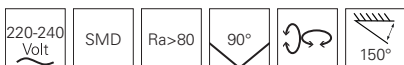



DRACONIS

- light colour and output adjustable via dip switch
- high luminous intensity [bis 8200 lm]
- aluminium diecast
- dimensions L x W x H: 578 x 189 x 129 mm
- socket L x W x H: 102 x 88 x 25 mm

item	colour	colour temperature	light current	price
620120	<input type="checkbox"/> white	WW NW 2700 / 3500 / 4000 K	8215 lm	379,95 €
620119	<input type="checkbox"/> aluminium	WW NW 2700 / 3500 / 4000 K	8215 lm	379,95 €

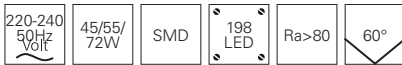

suitable
ceiling lights
page 83
348128
348099



accessories

930577	15° lens asymmetric 6 lenses installed per luminaire	9,95 €
930544	20° lens symmetrisch 6 lenses installed per luminaire	9,95 €
930545	30° lens symmetrisch 6 lenses installed per luminaire	9,95 €
930546	90° lens symmetrisch 6 lenses installed per luminaire	9,95 €

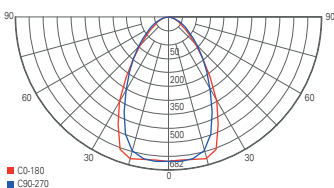

light distribution curve 620119 - 45 W

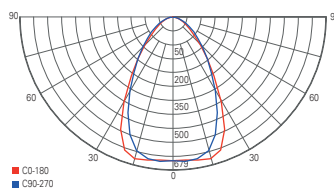

light distribution curve 620119 - 55 W

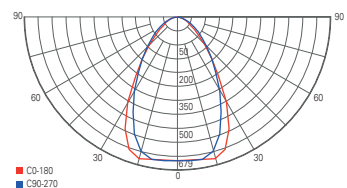

light distribution curve 620119 - 72 W



ALNITAK 25-34W

- aluminium
- dimensions L x W x H: 336 x 36 x 49 mm
- power: 25-34 W adjustable via dip switch
- UGR <16
- exclusively for 3-phase power rails from D LINE, Ivela and Hoffmeister

item	colour	colour temperature	light current	price
707110	<input type="checkbox"/> white	3000 K	3114 lm	181,95 €
707111	<input type="checkbox"/> white	4000 K	3068 lm	181,95 €
707112	<input type="checkbox"/> silver coloured	3000 K	3114 lm	181,95 €
707113	<input type="checkbox"/> silver coloured	4000 K	3068 lm	181,95 €
707114	<input type="checkbox"/> black	3000 K	3114 lm	181,95 €
707115	<input type="checkbox"/> black	4000 K	3068 lm	181,95 €



accessories

930386	reflector 12° silver coloured	2,15 €
930387	reflector 48° silver coloured	2,15 €
930388	Anti Glare white	2,99 €



LINEAR 60 + 100

• aluminium

item	colour	colour temperature	light current	dimensions L x W x H	power	price
707046	white	3000 K	1655 lm	687 x 33 x 52 mm	19 W	134,95 €
707015	white	4000 K	1655 lm	687 x 33 x 52 mm	19 W	134,95 €
707048	silver coloured	3000 K	1655 lm	687 x 33 x 52 mm	19 W	134,95 €
707045	silver coloured	4000 K	1655 lm	687 x 33 x 52 mm	19 W	134,95 €
707047	black	3000 K	1655 lm	687 x 33 x 52 mm	19 W	134,95 €
707034	black	4000 K	1655 lm	687 x 33 x 52 mm	19 W	134,95 €
707087	white	3000 K	2900 lm	1087 x 33 x 52 mm	30 W	179,95 €
707084	white	4000 K	2900 lm	1087 x 33 x 52 mm	30 W	179,95 €
707089	silver coloured	3000 K	2435 lm	1087 x 33 x 52 mm	30 W	179,95 €
707086	silver coloured	4000 K	2435 lm	1087 x 33 x 52 mm	30 W	179,95 €
707088	black	3000 K	2900 lm	1087 x 33 x 52 mm	30 W	179,95 €
707085	black	4000 K	2900 lm	1087 x 33 x 52 mm	30 W	179,95 €

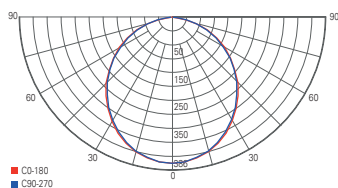

light distribution curve LINEAR 60

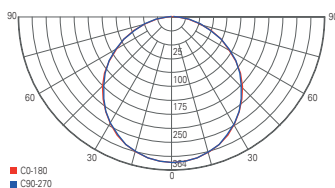

light distribution curve LINEAR 100



CAN

- aluminium diecast
- dimensions L x Ø: 134 x 60 mm

item	colour	price
707079	<input type="checkbox"/> white	49,95 €
707080	<input type="checkbox"/> silver coloured	49,95 €
707081	<input type="checkbox"/> black	49,95 €



accessories

930301	reflector ring H: 28 mm white	4,95 €
930302	reflector ring H: 28 mm black	4,95 €
930303	reflector ring H: 28 mm gold optics mat	4,95 €
930366	reflector ring H: 28 mm silver coloured	4,95 €

suitable illuminants on page 767-768

HORUS

If you are looking for a slim, powerful and flexibly usable 3-phase spotlight, you will not get past the Horus. The slim housing and the matt finish of the surface, combined with the powerful chip through all wattages, makes the Horus a true all-rounder in its field.



HORUS

- plastic
- UGR <19

item	colour	colour temperature	light current	dimensions L x Ø	power	light source	price
707095	□ white	WW 3000 K	625 lm	125 x 60 mm	7 W	6 LED	75,95 €
707097	□ white	NW 4000 K	635 lm	125 x 60 mm	7 W	6 LED	75,95 €
707094	■ black	WW 3000 K	625 lm	125 x 60 mm	7 W	6 LED	75,95 €
707096	■ black	NW 4000 K	635 lm	125 x 60 mm	7 W	6 LED	75,95 €
707099	□ white	WW 3000 K	915 lm	140 x 70 mm	10 W	12 LED	85,95 €
707101	□ white	NW 4000 K	1030 lm	140 x 70 mm	10 W	12 LED	85,95 €
707098	■ black	WW 3000 K	915 lm	140 x 70 mm	10 W	12 LED	85,95 €
707100	■ black	NW 4000 K	1030 lm	140 x 70 mm	10 W	12 LED	85,95 €
707103	□ white	WW 3000 K	1705 lm	185 x 80 mm	20 W	14 LED	95,95 €
707105	□ white	NW 4000 K	1785 lm	185 x 80 mm	20 W	14 LED	95,95 €
707102	■ black	WW 3000 K	1705 lm	185 x 80 mm	20 W	14 LED	95,95 €
707104	■ black	NW 4000 K	1785 lm	185 x 80 mm	20 W	14 LED	95,95 €
707107	□ white	WW 3000 K	2525 lm	210 x 90 mm	30 W	21 LED	115,95 €
707109	□ white	NW 4000 K	2605 lm	210 x 90 mm	30 W	21 LED	115,95 €
707106	■ black	WW 3000 K	2525 lm	210 x 90 mm	30 W	21 LED	115,95 €
707108	■ black	NW 4000 K	2605 lm	210 x 90 mm	30 W	21 LED	115,95 €

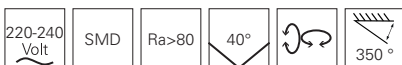

AARON

Hardly any other area of application places such high demands on flexible illumination as retail. With the 3-phase spotlights of the AARON series, DEKO-LIGHT has a solution in its portfolio that is especially aimed at shops with high ceilings. With its 7400 lm and a beam angle of 40°, the 230V power rails spot perfectly sets the scene for shops, exhibitions and trade fair areas.



AARON

- aluminium
- dimensions L x W x Ø: 255 x 182 x 120 mm

item	colour	colour temperature	light current	price
707092	□ white	☀ 3000 K	7400 lm	529,95 €
707093	□ white	☀ 4000 K	7400 lm	529,95 €
707090	■ black	☀ 3000 K	7400 lm	529,95 €
707091	■ black	☀ 4000 K	7400 lm	529,95 €

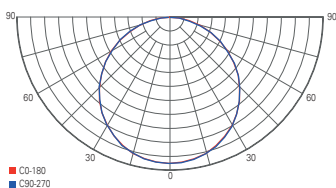

light distribution curve



NIHAL MINI

- aluminium diecast
- dimensions L x W x H x Ø: 94 x 102 x 139 x 60 mm
- dimmable via phase control or phase cut-off

item	colour	colour temperature	light current	price
707036	<input type="checkbox"/> white	3000 K	950 lm	164,95 €
707038	<input type="checkbox"/> white	4000 K	1180 lm	164,95 €
707054	<input type="checkbox"/> silver coloured	3000 K	950 lm	164,95 €
707055	<input type="checkbox"/> silver coloured	4000 K	1180 lm	164,95 €
707037	<input type="checkbox"/> black	3000 K	950 lm	164,95 €
707039	<input type="checkbox"/> black	4000 K	1180 lm	164,95 €

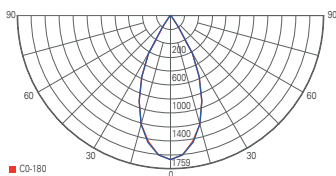
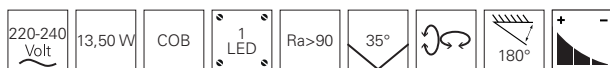

light distribution curve



accessories

930301	reflector ring white	4,95 €
930302	reflector ring black	4,95 €
930303	reflector ring gold	4,95 €
930366	reflector ring silver	4,95 €
930297	side cover white	3,95 €
930298	side cover black	3,95 €
930299	side cover gold	3,95 €
930300	side cover wooden look	5,95 €
930364	side cover silver	3,95 €
930306	reflector 50°	10,95 €
930307	honeycomb filter	10,95 €
930308	spread lens 40° clear/satined	10,95 €
930309	softening lens 47° satined	10,95 €
930310	linear spread lens 40°/80° asymmetric clear/satined	10,95 €



NIHAL

- aluminium diecast
- dimensions L x W x H x Ø: 135 x 138 x 188 x 86 mm
- dimmable via phase control or phase cut-off

item	colour	colour temperature	light current	price
707040	<input type="checkbox"/> white	3000 K	2450 lm	209,95 €
707042	<input type="checkbox"/> white	4000 K	2860 lm	209,95 €
707056	<input type="checkbox"/> silver coloured	3000 K	2470 lm	209,95 €
707057	<input type="checkbox"/> silver coloured	4000 K	2860 lm	209,95 €
707041	<input type="checkbox"/> black	3000 K	2450 lm	209,95 €
707043	<input type="checkbox"/> black	4000 K	2860 lm	209,95 €

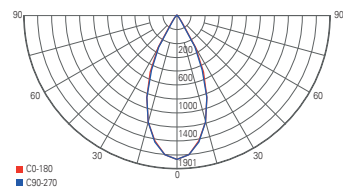
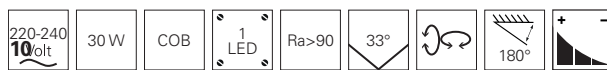

light distribution curve



accessories

930315	reflector ring white	4,95 €
930316	reflector ring black	4,95 €
930317	reflector ring gold	4,95 €
930365	reflector ring silver	4,95 €
930311	side cover white	5,95 €
930312	side cover black	5,95 €
930313	side cover gold	5,95 €
930314	side cover wooden look	7,95 €
930363	side cover silver	5,55 €
930318	reflector 15°	17,95 €
930320	reflector 50°	17,95 €
930321	honeycomb filter	10,95 €
930322	spread lens 40° clear/satined	10,95 €
930323	softening lens 47° satined	10,95 €
930324	linear spread lens 40°/80° asymmetric clear/satined	10,95 €

PLEIONE FOCUS

Power rails convince in shops, showrooms, offices and more with their unrivalled flexibility. The PLEIONE FOCUS I and II track-mounted spotlights crown this flexibility by enabling the beam angle to be continuously adjusted in the range from 25° to 60°. At the same time, the lens can be focused to highlight objects and surfaces precisely and with high colour fidelity.



PLEIONE FOCUS I

- aluminium diecast
- dimensions L x H x Ø: 181 x 180 x 68 mm
- fokussierbare lens
- light cone infinitely adjustable [25°-60°]

item	colour	colour temperature	light current	price
707069	<input type="checkbox"/> white	3000 K	1100 lm	209,95 €
707070	<input type="checkbox"/> white	4000 K	1150 lm	209,95 €

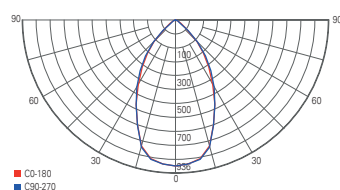

light distribution curve 707069

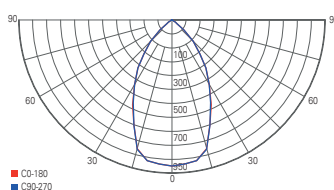

light distribution curve 707070



Mit freundlicher Unterstützung von Küchen Leicht Ettlingen / Projekt: Leicht Küchenstudio Ettlingen / Planung / Umsetzung: CS Elektroanlagen Ettlingen



PLEIONE FOCUS II

- aluminium diecast
- dimensions L x H x Ø: 195 x 160 x 90 mm
- fokussierbare lens
- light cone infinitely adjustable [25°-60°]

item	colour	colour temperature	light current	price
707067	<input type="checkbox"/> white	3000 K	3050 lm	299,95 €
707068	<input type="checkbox"/> white	4000 K	3300 lm	299,95 €

--	--	--	--	--	--	--	--	--

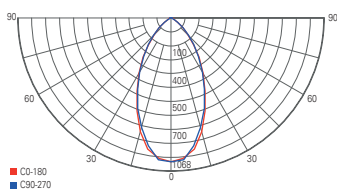

light distribution curve 707067

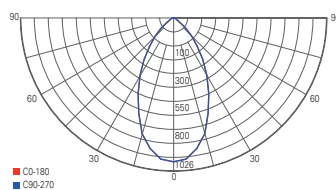

light distribution curve 707068



suitable
pendant lights
page 13
342177
342178

LUCEA 10

- aluminium diecast
- dimensions H x Ø: 249 x 65 mm
- dimmable via phase control or phase cut-off
- light color adjustable via DIP switch

item	colour	colour temperature	light current	price
707116	<input type="checkbox"/> white	<input type="checkbox"/> 3000 / 4000 K	930 / 1000 lm	139,95 €
707117	<input checked="" type="checkbox"/> black	<input checked="" type="checkbox"/> 3000 / 4000 K	930 / 1000 lm	139,95 €

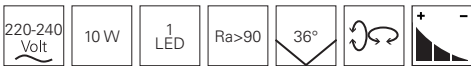

suitable
ceiling surface-
mounted lamps
from page 84
348153
348154
348161
348162

accessories

930679 lens 24° **9,95 €**





suitable
pendant lights
page 13
342179-342182

LUCEA 15 + 20

- aluminium diecast
- dimensions H x Ø: 269 x 85 mm
- dimmable via phase control or phase cut-off
- light color adjustable via DIP switch

item	colour	colour temperature	light current	power	price
707118	□ white	ww nw 3000 / 4000 K	1460 / 1500 lm	15 W	159,95 €
707119	■ black	ww nw 3000 / 4000 K	1460 / 1500 lm	15 W	159,95 €
707120	□ white	ww nw 3000 / 4000 K	1930 / 2000 lm	20 W	179,95 €
707121	■ black	ww nw 3000 / 4000 K	1930 / 2000 lm	20 W	179,95 €



suitable
ceiling surface-
mounted lamps
from page 84
348155-348158
348163-348166

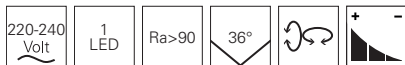

accessories

930680	lens 24°	12,95 €
930681	lens 60°	12,95 €



suitable
ceiling surface-
mounted lamps
from page 84
348159
348160
348167
348168

LUCEA 30

- aluminium diecast
- dimensions H x Ø: 302 x 100 mm
- dimmable via phase control or phase cut-off
- light color adjustable via DIP switch

item	colour	colour temperature	light current	price
707122	□ white	ww nw 3000 / 4000 K	2700 / 2900 lm	199,95 €
707123	■ black	ww nw 3000 / 4000 K	2700 / 2900 lm	199,95 €

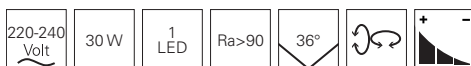

accessories

930682	lens 24°	15,95 €
930684	lens 60°	15,95 €
930677	barn door white	24,95 €
930678	barn door black	24,95 €





suitable
pendant lights
page 13
342177
342178



suitable
ceiling surface-
mounted lamps
from page 84
348153
348154
348161
348162

LUCEA 10

- aluminium diecast
- dimensions H x Ø: 157 x 65 mm
- max. suspension: 1800 mm
- dimmable via phase control or phase cut-off
- light color adjustable via DIP switch

item	colour	colour temperature	light current	price
707124	□ white	ww nw 3000 / 4000 K	930 / 1000 lm	149,95 €
707125	■ black	ww nw 3000 / 4000 K	930 / 1000 lm	149,95 €



accessories

930679 lens 24° **9,95 €**



LUCEA 15 + 20

- aluminium diecast
- dimensions H x Ø: 178 x 85 mm
- max. suspension: 1800 mm
- dimmable via phase control or phase cut-off
- light color adjustable via DIP switch

item	colour	colour temperature	light current	power	price
707126	□ white	ww nw 3000 / 4000 K	1460 / 1500 lm	15 W	169,95 €
707127	■ black	ww nw 3000 / 4000 K	1460 / 1500 lm	15 W	169,95 €
707128	□ white	ww nw 3000 / 4000 K	1930 / 2000 lm	20 W	189,95 €
707129	■ black	ww nw 3000 / 4000 K	1930 / 2000 lm	20 W	189,95 €

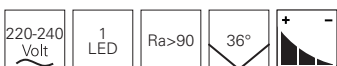

accessories

930680 lens 24° **12,95 €**

930681 lens 60° **12,95 €**



suitable
pendant lights
page 13
342179
342180
342181
342182



suitable
ceiling surface-
mounted lamps
from page 84
348155-348158
348163-348166



SLIM

- aluminium diecast
- dimensions H x Ø: 300 x 39 mm
- max. suspension: 1800 mm
- textile cable
- UGR <19

item	colour	colour temperature	light current	price
707133	<input type="checkbox"/> white	3000 K	500 lm	89,95 €
707132	<input checked="" type="checkbox"/> black	3000 K	500 lm	89,95 €

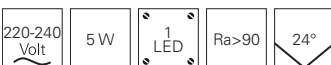

suitable
pendant lights
page 14
342214
342213



UNI II

- aluminium diecast
- dimensions L x Ø: 167 x 100 mm
- dimmable via phase control or phase cut-off

item	colour	colour temperature	light current	price
707044	white	3000 K	910 lm	179,95 €
707131	black	3000 K	910 lm	179,95 €

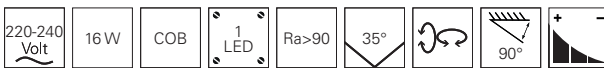

suitable ceiling surface-mounted lamps from page 76

348124
348176
348125
348175
348107
348210



accessories

930339	reflector ring black	11,95 €
930340	reflector ring gold	11,95 €
930341	reflector ring chrom	11,95 €
930371	reflector ring II black glossy	10,95 €
930335	cover backside black	3,55 €
930337	cover heatsink black	3,55 €
930306	reflector 50°	10,95 €
930307	honeycomb filter	10,95 €
930308	spread lens 40° clear/satined	10,95 €
930309	softening lens 47° satined	10,95 €
930310	linear spread lens 40°/80° asymmetric clear/satined	10,95 €



STUDIO PAR 30

- aluminium
- dimensions L x H: 271 x 159 mm
- integrated splinter protection grid
- incl. adapter

item	colour	price
707083	□ silver coloured	69,95 €
707082	■ black	69,95 €



accessories

001623	barn door silver coloured	29,95 €
001621	barn door black	29,95 €

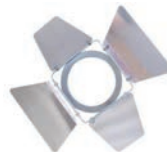

suitable illuminants on page 770- 771



BATTERY AND SOLAR LIGHTS

342 battery lights

354 solar lights



Color swatches: white, grey, black, red, yellow, blue, green.
page 344



Color swatches: white, grey, black, red, yellow, blue, green.
page 344



Color swatches: white, grey, black, red, yellow, blue, green.
page 345



Color swatches: white, grey, black, red, yellow, blue, green.
page 345



Color swatches: white, grey.
page 346



Color swatches: white, grey, black.
page 348



Color swatches: white, black.
page 351



Color swatches: white, black.
page 351



Color swatches: black.
page 352



Color swatches: black.
page 355



Color swatches: black, white.
page 355



Color swatches: black.
page 357



Color swatches: black.
page 357



Color swatches: black.
page 358



battery and solar lights



MIRAM

Combine & shine – with the MIRAM series, there are no more limits to your creativity. Simply combine the luminaire head in your favourite colour with a stand, a wall bracket or a pendant fixture of your choice. In this way, you can create your very own individual luminaire in the twinkling of an eye and recombine it at any time without tools. Flexible, simple, chic - that is MIRAM combine & shine.

it's that simple:

- choose a luminaire head in your favourite colour
- select the desired fastening in your favourite colour

your advantages::

- USB-C cable included
- 147 possible combinations



346025



346033



346032



346034



346035



346036



346037



930625



930627



930626



930628



930629



930630



930631



930618



930620



930619



930621



930622



930623



930624



930611



930613



930612



930614



930615



930616



930617





HEAD MAGNETIC LIGHT MIRAM

- high battery life [>10h]
- easy charging via charging station with USB cable [incl.]
- >190lm
- infinitely dimmable via touch sensor
- can be combined with all brackets of the series thanks to magnetic attachment
- aluminium diecast
- dimensions H x Ø: 30 x 120 mm

item	colour	colour temperature	light current	price
346025	white	3000 K	196 lm	115,95 €
346033	grey	3000 K	196 lm	115,95 €
346032	black	3000 K	196 lm	115,95 €
346034	red	3000 K	196 lm	115,95 €
346035	yellow	3000 K	196 lm	115,95 €
346036	blue	3000 K	196 lm	115,95 €
346037	green	3000 K	196 lm	115,95 €



STAND FOR MAGNETIC LIGHT MIRAM

- can be combined as desired with any luminaire head from the MIRAM series
- aluminium diecast
- dimensions H x Ø: 270 x 102 mm

item	colour	price
930611	white	35,95 €
930613	grey	35,95 €
930612	black	35,95 €
930614	red	35,95 €
930615	yellow	35,95 €
930616	blue	35,95 €
930617	green	35,95 €



WALL BRACKET FOR MAGNETIC LIGHT MIRAM

- can be combined as desired with any luminaire head from the MIRAM series
- aluminium diecast
- dimensions W x H: 85 x 96 mm
- socket Ø: 60 mm

item	colour	price
930618	 white	19,95 €
930620	 grey	19,95 €
930619	 black	19,95 €
930621	 red	19,95 €
930622	 yellow	19,95 €
930623	 blue	19,95 €
930624	 green	19,95 €



PENDANT FOR MAGNETIC LIGHT MIRAM

- can be combined as desired with any luminaire head from the MIRAM series
- mounting without drilling and screwing
- aluminium diecast
- dimensions W x H: 205 x 185 mm
- max. suspension: 2190 mm

item	colour	price
930625	 white	34,95 €
930627	 grey	34,95 €
930626	 black	34,95 €
930628	 red	34,95 €
930629	 yellow	34,95 €
930630	 blue	34,95 €
930631	 green	34,95 €

CRUCIS

Powerful performance with a straightforward design: that is our CRUCIS rechargeable luminaire. Whether for a cosy get-together in the garden or as a discreet source of light in a restaurant or beer garden.

With its simple, timeless look, its long battery life and the charging base included in the scope of delivery, nothing stands in the way of a convivial evening outdoors – let alone an impractical cable.



CRUCIS

- high battery life [>10h]
- incl. charging station with USB cable
- >160lm
- infinitely dimmable via touch sensor
- aluminium diecast
- dimensions L x W x H: 100 x 100 x 292 mm
- socket L x W x H: 79 x 79 x 17 mm

item	colour	colour temperature	light current	price
346041	<input type="checkbox"/> white	3000 K	165 lm	109,95 €
346043	<input checked="" type="checkbox"/> grey	3000 K	165 lm	109,95 €





ALGIEBA

The smart table lamp with that certain something! Our battery lamp ALGIEBA not only impresses with its design and robust quality. It also offers that certain something for balmy summer nights outdoors thanks to an inductive charging panel that can be switched on via a touch switch!

No more battery problems or tangled cables. Even while charging your smartphone, the light performance does not suffer in the slightest.

The charging option of the included USB-C charging base completes the sophisticated concept of this unique battery light.



ALGIEBA

- high battery life [>10h]
if charging panel is not used
- incl. charging station with USB cable
- >200lm
- infinitely dimmable via touch sensor
- switchable wireless charging panel for smartphones
- aluminium diecast
- dimensions L x W x H: 175 x 92 x 330 mm
- socket L x W x H: 175 x 103 x 15 mm

item	colour	colour temperature	light current	price
346038	white	3000 K	212 lm	169,95 €
346040	grey	3000 K	212 lm	169,95 €
346039	black	3000 K	212 lm	169,95 €







SHERATAN

The SHERATAN is a battery-operated LED table lamp that can be charged via an integrated USB connection. This makes the SHERATAN suitable not only for use as accent light in living rooms, but also at events such as galas, corporate events and garden parties. The 38 cm high housing with wavy or smooth lampshade and stable base plate made of robust die-cast aluminium [IP54] houses a 2.2 watt LED bulb that produces a pleasant warm white light with 3000 K and can be switched on and off via a touch sensor.

SHERATAN I DIM

- infinitely dimmable via touch sensor
- noble look
- IP54
- aluminium diecast
- dimensions L x W x H x Ø: 100 x 100 x 380 x 110 mm
- socket L x W x H: 100 x 100 x 11 mm
- USB-Micro charging socket
- incl. lithium battery | 2x 2200 mAh



item	colour	colour temperature	light current	price
346011	white	3000 K	154 lm	129,95 €
346012	black	3000 K	154 lm	129,95 €



accessories

930460 230V USB plug-in power supply incl. micro-USB connection cable **19,95 €**

SHERATAN II DIM

- infinitely dimmable via touch sensor
- noble look
- IP54
- aluminium diecast
- dimensions L x W x H x Ø: 100 x 100 x 380 x 115 mm
- socket L x W x H: 100 x 100 x 11 mm
- USB-Micro charging socket
- incl. lithium battery | 2x 2200 mAh



item	colour	colour temperature	light current	price
346013	white	3000 K	154 lm	129,95 €
346014	black	3000 K	154 lm	129,95 €

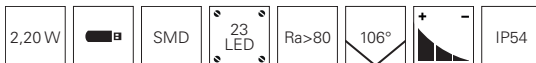

accessories

930460 230V USB plug-in power supply incl. micro-USB connection cable **19,95 €**

LACERTAE USB

Be outside, have fun and simply take the light with you. No problem with this faithful companion. Thanks to its 3-stage dimming function, the LACERTAE USB is a favourite for cosy reading by the lake or a romantic picnic in the park. With the integrated power bank, it not only supports your garden party with light, but also ensures that the music doesn't run out of steam. The LACERTAE USB – a must-have for all those who want to be free.



LACERTAE USB

- portable
- powerbank function with USB-A socket
- three-stage dimmable
- incl. 7800mAh lithium battery
- real glass panes
- aluminium diecast
- dimensions L x W x H: 180 x 180 x 267 mm
- socket L x W x H: 145 x 145 x 25 mm
- USB-Micro charging socket

item	colour	colour temperature	light current	price
346009	■ dark grey	■ 3000 K	460 lm	169,95 €



accessories

930460	230V USB plug-in power supply incl. micro-USB connection cable	19,95 €
---------------	--	----------------



suitable
wall light
page 400
731112





SAMAS SOLAR

Not everywhere you want light, there is also electricity. We have the solution. The SAMAS SOLAR series only needs one thing to shine; sunshine every now and then. Thanks to its intelligent economy mode, in which it shines with only 15% light output when not in use, it has a particularly long burning time. As soon as it detects approach via its integrated sensor, it shines with full power. It can also be deactivated via a push-button. The powerful light output combined with the latest technology for long operating times is a real problem solver for walls, tables and gardens.



SAMAS SOLAR

- aluminium diecast
- dimensions L x W x H: 154 x 140 x 290 mm
- socket L x W x H: 110 x 30 x 12 mm
- motion / twilight sensor
- highly efficient solar panel
- incl. Li-Ion battery | 3,70V | 2200 mA

item	colour	colour temperature	light current	price
731122	■ dark grey	☀ 3000 K	130 lm	129,95 €

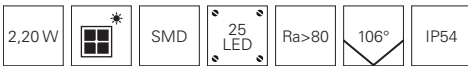

SAMAS SOLAR

- aluminium diecast
- dimensions L x W: 140 x 140 mm
- socket L x W x H: 100,50 x 100,50 x 22,00 mm
- motion / twilight sensor
- highly efficient solar panel
- incl. Li-Ion battery | 3,70V | 2200 mAh
- incl. ground spike



item	colour	colour temperature	light current	dimensions H	price
733049	■ dark grey	☀ 3000 K	170 lm	340 mm	119,95 €
733050	■ dark grey	☀ 3000 K	135 lm	500 mm	139,95 €

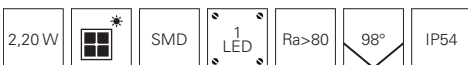



SOLAR PREMIUM

The SOLAR PREMIUM series impresses with its futuristic design and functions as an innovative and decorative outdoor luminaire in the outdoor and garden area. The power supply is provided by the integrated rechargeable battery including solar panel, so that no visually disturbing or complicated cables are necessary.

SOLAR PREMIUM I

- aluminium
- dimensions L x W x H: 160,5 x 233,2 x 152 mm
- socket L x W x H: 160,5 x 31,5 x 80,5 mm
- motion / twilight sensor
- highly efficient solar panel
- incl. Li-Ion battery | 3,70V | 2200 mA



item	colour	colour temperature	light current	price
731116	■ dark grey	www 3200 K	170 lm	169,95 €

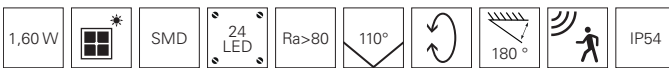

SOLAR PREMIUM I

- aluminium
- dimensions L x W x H: 200 x 151 x 1000 mm
- socket L x W x H: 80 x 151 x 4,5 mm
- motion / twilight sensor
- highly efficient solar panel
- incl. Li-Ion battery | 3,70V | 2200 mA



item	colour	colour temperature	light current	price
733046	■ dark grey	www 3200 K	170 lm	199,95 €

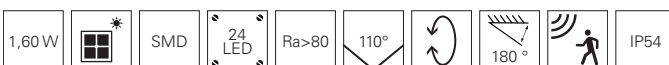

LUGH SOLAR

The LUGH SOLAR is a modern path luminaire for outdoor use, which thanks to the integrated twilight sensor automatically switches on at a preset value. At the same time, the shapely floor lamp reduces electricity costs thanks to the permanently installed solar panel on the top, which charges the integrated battery and thus enables flexible positioning, independent of installed power cables.



LUGH SOLAR

- aluminium diecast
- dimensions L x W x H: 140,5 x 140,5 x 340 mm
- socket L x W x H: 138,0 x 138,0 x 35,0 mm
- twilight sensor
- power consumption: 2,20 W
- incl. Li-Ion battery | 3,70V | 2200 mAh

item	colour	colour temperature	light current	price
733051	■ dark grey	■ 3000 K	130 lm	139,95 €

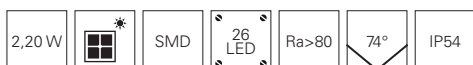





OUTDOOR LIGHTS

- 362 bollard lights
- 386 surface mounted wall lights
- 424 ceiling and wall lights
- 430 built in wall lights
- 440 spherical and floor lamps
- 446 energy distributor
- 454 surface mounted and ground spike lights
- 468 wall washer
- 472 ground recessed lights
- 502 underwater lights
- 508 floodlight
- 516 display lights



□
page 364



□ □
364



□
page 365



□
page 365



□
page 366



□
page 366



■
page 367



■ ■ □
page 369



■ □
page 370



■ □
page 372



■ □
page 374



■ □
page 374



■ □
page 375



■ □
page 375



■
page 376



■
page 377



■
page 377



■ □
page 379



■ □
page 380



■
page 382



■ □
page 385



bollard lights



ESTADA

- stainless steel
- dimensions H x Ø: 1000 x 100 mm
- socket Ø: 170 mm
- dimmable via optional illuminants

item	colour	price
730009	<input type="checkbox"/> silver coloured	119,95 €



suitable illuminants on page 770-771
suitable mounting accessories for outdoor use from page 800



PORRIMA

- stainless steel
- socket H x Ø: 8 x 118 mm
- dimmable via optional illuminants

item	colour	dimensions H x Ø	price
733012	<input type="checkbox"/> silver coloured brushed	500 x 76 mm	59,95 €
733028	<input type="checkbox"/> silver coloured brushed	1000 x 76 mm	69,95 €



suitable illuminants on page 770-771
suitable mounting accessories for outdoor use from page 800



NOVA

- stainless steel
- dimensions H x Ø: 1100 x 75 mm
- socket Ø: 110 mm
- dimmable via optional illuminants
- E27 socket suitable for A19 LED bulb

item	colour	price
730007	 silver coloured brushed	74,95 €



suitable mounting accessories for outdoor use from page 800



suitable
wall light
page 392
730034

NOVA MOTION

- stainless steel
- dimensions H x Ø: 1100 x 75 mm
- socket Ø: 110 mm
- motion / twilight sensor
- E27 socket suitable for A19 LED bulb

item	colour	price
730032	 silver coloured brushed	89,95 €



suitable mounting accessories for outdoor use from page 800



suitable
wall lights
page 392
730034

ZILLY II

- stainless steel
- dimensions L x W: 500 x 140 mm
- socket H x Ø: 7 x 100 mm
- swivelling luminaire head
- dimmable via optional illuminants

item	colour	price
733062	<input type="checkbox"/> silver coloured	89,95 €



suitable illuminants on page 767
suitable mounting accessories for outdoor use from page 800



suitable
wall lights
page 391
731008
731009

ZILLY II

- stainless steel
- dimensions L x W: 1000 x 232 mm
- socket H x Ø: 7 x 100 mm
- swivelling luminaire head
- dimmable via optional illuminants

item	colour	price
733063	<input type="checkbox"/> silver coloured	129,95 €



suitable illuminants on page 767
suitable mounting accessories for outdoor use from page 800



suitable
wall lights
page 391
731010
731011



ARBINTO

The ARBINTO with its high standing base and the light emission with E27 bulb as well as real glass frame reminds of a torch and creates an immediate feeling of warmth and security.

ARBINTO

- aluminium diecast
- dimensions L x W: 800 x 120 mm
- socket Ø: 140 mm
- dimmable via optional illuminants

item	colour	price
733061	 anthracite	119,95 €



suitable illuminants on page 770-771
 suitable mounting accessories for outdoor use from page 800





FACADO

The floor lamps of the FACADO series have already been used for some time on paved walkways in the garden area. With FACADO, the classically elegant outdoor lights [IP44] become even more versatile. Thanks to the E27 socket, the light source can be changed as needed and adapted to the desired lighting mood. FACADO is available in two heights [65 and 100 cm]. This series is rounded off with the new energy distributor on page 453.



suitable
wall light
page 392
731059



suitable energy
distributor
page 453
733064
733065

FACADO A + B

- aluminium diecast
- socket L x W: 110 x 110 mm
- dimmable via optional illuminants

item	colour	dimensions L x W x H	price
730332	■ anthracite	110 x 110 x 650 mm	119,95 €
730333	■ brown	110 x 110 x 650 mm	119,95 €
733018	■ anthracite	110 x 110 x 1000 mm	176,95 €



suitable illuminants on page 770-771

suitable mounting accessories for outdoor use from page 800

CATA IV

The CATA IV series is not only convincing as a modern path luminaire, but also as an independent light and design object in the design of outdoor areas. The LEDs not only provide wide-area illumination of walkways and entrance areas, but also inevitably draw the eye to the striking frame construction. Available in three sizes, the CATA IV models can also be combined very well.



CATA IV

- aluminium diecast
- socket L x W x H: 145 x 55 x 20 mm

item	colour	colour temperature	light current	dimensions L x W x H	price
733040	■ anthracite	ww 3000 K	170 lm	151 x 61 x 500 mm	189,95 €
733041	■ anthracite	ww 3000 K	170 lm	151 x 61 x 700 mm	209,95 €
733042	■ anthracite	ww 3000 K	170 lm	151 x 61 x 1000 mm	235,95 €

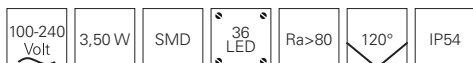

suitable mounting accessories for outdoor use from page 800



CHERTAN

With its unusual material mix of die-cast aluminium housing and a concrete base, the CHERTAN outdoor floor lamp stands out visually from other models. With its pleasant warm white light and a beam angle of 120° including motion and twilight switch, the outdoor luminaire is perfect for decorative use in entrance areas, on walkways or in the garden.



CHERTAN

- aluminium diecast | concrete
- socket L x W x H: 160 x 30 x 40 mm

item	colour	colour temperature	light current	dimensions L x W x H	price
733043	■ grey	ww 3000 K	480 lm	170 x 72 x 450 mm	199,95 €
733044	■ grey	ww 3000 K	530 lm	170 x 72 x 600 mm	219,95 €
733045	■ grey	ww 3000 K	640 lm	170 x 72 x 1000 mm	239,95 €

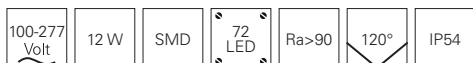

suitable mounting accessories for outdoor use from page 800



suitable wall light
page 419
731113

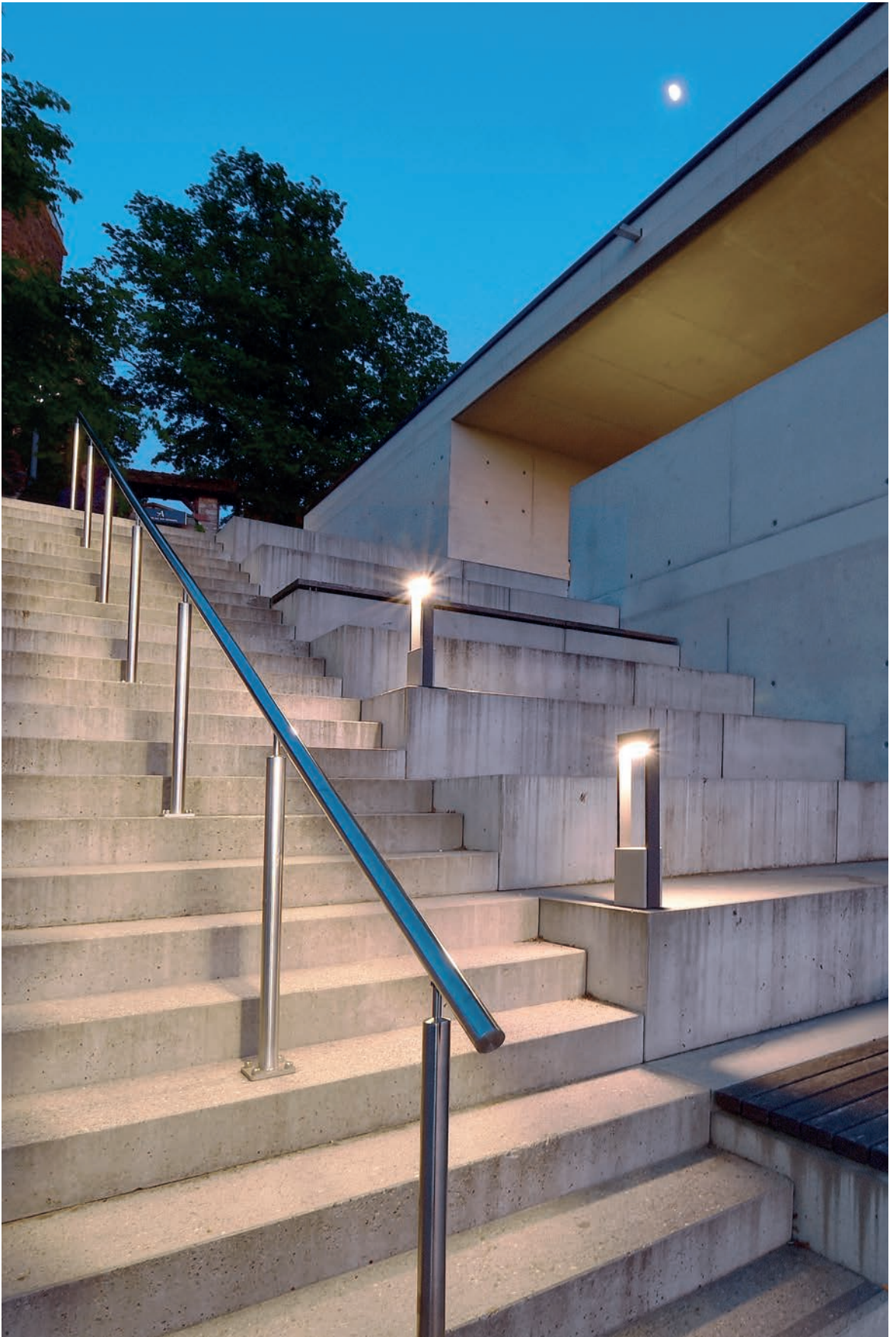

RUKBAT

- aluminium diecast
- socket L x W x H: 145 x 145 x 20 mm



item	colour	colour temperature	light current	dimensions L x W x H	price
733047	■ anthracite	www 3000 K	670 lm	85 x 85 x 500 mm	159,95 €
733048	■ anthracite	www 3000 K	670 lm	85 x 85 x 800 mm	219,95 €



suitable mounting accessories for outdoor use from page 800

ANTLIAE

- aluminium diecast
- socket L x W x H: 152 x 121 x 20 mm



item	colour	colour temperature	light current	dimensions L x W x H	price
733033	■ dark grey	www 3000 K	380 lm	152 x 121 x 150 mm	109,95 €
733034	■ dark grey	www 3000 K	650 lm	152 x 121 x 500 mm	139,95 €
733035	■ dark grey	www 3000 K	650 lm	152 x 121 x 800 mm	159,95 €



suitable mounting accessories for outdoor use from page 800



TRILA + TRILA II

- aluminium diecast
- dimensions L x W x H: 128,5 x 123 x 800 mm
- socket Ø: 120 mm

item	colour	colour temperature	light current	price
730364	■ anthracite	☀ 3000 K	361 lm	159,95 €
730365	■ anthracite	☀ 3000 K	361 lm	159,95 €



suitable mounting accessories for outdoor use from page 800



BEACON II MOTION

- aluminium diecast
- socket L x W x H: 102 x 102 x 7 mm
- motion / twilight sensor

item	colour	colour temperature	light current	dimensions L x W x H	price
733006	■ anthracite	☀ 3000 K	290 lm	70 x 70 x 500 mm	139,95 €
733008	■ anthracite	☀ 3000 K	290 lm	70 x 70 x 800 mm	159,95 €









suitable mounting accessories for outdoor use from page 800

suitable
wall light
page 400
731016

ORTIS

- aluminium diecast
- dimensions L x Ø: 1000 x 120 mm
- light dimmed by the louvre insert, light directed downwards

item	colour	colour temperature	light current	price
733004	 dark grey	 3000 K	510 lm	219,95 €

 220-240 Volt	 15 W	 COB	 1 LED	 Ra>80	 360°	 IP54
---	--	---	---	---	--	--

suitable mounting accessories for outdoor use from page 800



suitable
wall light
page 393
731031



IRETTA

- aluminium diecast
- dimensions L x W x H: 165 x 192 x 700 mm
- socket L x W: 165 x 85 mm

item	colour	colour temperature	light current	price
730354	■ anthracite	www 3000 K	240 lm	159,95 €

220-240 Volt	4 W	SMD	48 LED	Ra>80	110°	IP44
--------------	-----	-----	--------	-------	------	------

suitable mounting accessories for outdoor use from page 800



suitable wall light
page 405
730395

ROBI FLEX

- aluminium diecast
- dimensions L x W x H: 35 x 80 x 1000 mm
- socket L x W: 115 x 73 mm
- swivelling luminaire head

item	colour	colour temperature	light current	price
733007	■ dark grey	www 3000 K	700 lm	229,95 €

110-240 Volt	10 W	SMD	48 LED	Ra>80	110°	↻	90°	IP54
--------------	------	-----	--------	-------	------	---	-----	------

suitable mounting accessories for outdoor use from page 800



reddot award 2017
winner



suitable wall light
page 405
731068



TAYGETA

The outdoor lights of the TAYGETA series are eye-catchers – and use their bent housing shape sensibly for illumination of walkways on both sides, walls and objects from different angles on both sides. Available in two sizes [60 cm and 100 cm], the TAYGETA 1000 is also optionally available with integrated, energy-saving motion and twilight sensor.



TAYGETA 600 + 1000 + 1000 MOTION

- aluminium diecast
- dimensions L x W: 220 x 148 mm
- socket L x W x H: 220 x 90 x 10 mm

item	colour	colour temperature	light current	dimensions H	price
733037	■ dark grey	☀ 3000 K	1500 lm	600 mm	229,95 €
733038	■ dark grey	☀ 3000 K	1500 lm	1000 mm	259,95 €
733039	■ dark grey	☀ 3000 K	1500 lm	1000 mm motion / twilight sensor	279,95 €



suitable mounting accessories for outdoor use from page 800

TUCANAE

With its slim, unadorned housing design, TUCANAE is a modern outdoor luminaire that can be integrated almost anywhere. The 100 cm high bollard luminaire radiates its warm white light downwards at an angle onto walkways and other surfaces and, in the MOTION version, has an integrated twilight switch with adjustable brightness threshold and runtime.



TUCANAE + TUCANAE MOTION

- modern, minimalist design
- brightness threshold and running time adjustable [733068]
- aluminium diecast
- dimensions W x H: 206 x 1000 mm
- socket L x W x H: 120 x 180 x 10 mm

suitable
wall lights
page 404
731133
731144

item	colour	colour temperature	light current	price
733069	■ dark grey	☀ 3000 K	1650 lm	239,95 €
733068	■ dark grey	☀ 3000 K	1650 lm motion / twilight sensor	259,95 €

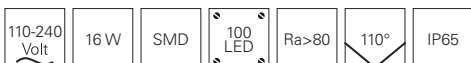

suitable mounting accessories for outdoor use from page 800



BERMUDA

Admittedly, a big name for a small luminaire. But in its design, the BERMUDA series undoubtedly presents itself as exciting as the well-known triangle. The small light dwarf is an enrichment for every garden and fits like a small mushroom into every outdoor environment. And by the way, it also cuts a fine figure as a wall luminaire.



suitable
wall light
IP65
page 418
731124



suitable
ground spike
lights
IP65
page 456
733060
733059



suitable
wall lights
page 170
342159
342160



suitable
table and
floor lights
page 212/213
346018
346017
343029
343028

BERMUDA

- design by Johannes Tomm
- eyecatcher outdoor lighting
- 360° beam angle
- aluminium diecast
- dimensions L x Ø: 600 x 200 mm
- dimmable via phase control or phase cut-off

item	colour	colour temperature	light current	price
733056	■ anthracite	☀ 3000 K	600 lm	219,95 €

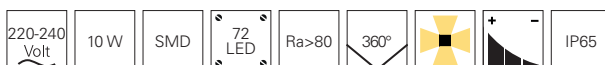

suitable mounting accessories for outdoor use from page 800





With the kind support of Arte Classica Schirzel / www.arte-classica.de

ALHENA

Thanks to its SMD construction, the modern, towering ALHENA luminaire with 360° light distribution not only illuminates driveways, car parks, gardens or terraces, but also appears as a design element itself.



ALHENA

- timeless design
- high luminous intensity
- homogeneous light distribution in all directions
- aluminium diecast
- socket Ø: 130 mm

item	colour	colour temperature	light current	dimensions H x Ø	price
733057	■ anthracite	☀ 3000 K	2965 lm	900 x 110 mm	239,95 €
733058	■ anthracite	☀ 3000 K	3900 lm	1500 x 110 mm	319,95 €



suitable mounting accessories for outdoor use from page 800



□
page 390



□ □
page 390



□ □
page 391



□ □
page 391



□
page 392



■
page 392



■
page 393



■
page 394



■
page 395



■
page 396



■
page 396



■ □
page 399



■ □
page 399



■
page 400



■
page 400



■ □
page 403



■ □
page 403



■ □
page 404



■
page 405



■
page 405



■ □
page 406



■
page 407



■ □
page 407



■ □
page 408



□ ■ ■
page 408



□ □ ■
page 409



■ □
page 409



■
page 411



■
page 411



■
page 412

surface mounted wall lights



■ □
page 412



■ □
page 414



■
page 414

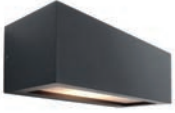

■ ■
page 415



■
page 415



■ □
page 416



■
page 416



■
page 417



■
page 418



■
page 419



■
page 420



■
page 421



■
page 423





ZILLY DOWN

- stainless steel
- dimensions L x W x H x Ø: 115 x 115 x 107 x 60 mm
- socket L x W x H: 80 x 50 x 25 mm
- dimmable via optional illuminants

item	colour	price
731005	 silver coloured	39,95 €





suitable illuminants on page 767



ZILLY UP AND DOWN + ZILLY UP AND DOWN MOTION

- stainless steel
- dimmable via optional illuminants [only 731006]

item	colour	dimensions L x W x H x Ø	socket L x W x H x Ø	price
731006	 silver coloured	163 x 107 x 60 x 60 mm	80 x 50 x 27 mm	54,95 €
731007	 silver coloured	215 x 110 x 70 x 60 mm	150 x 68 x 27 mm motion / twilight sensor	89,95 €



suitable illuminants on page 767



ZILLY II DOWN + ZILLY II DOWN MOTION

- stainless steel
- dimmable via optional illuminants [only 731008]

suitable
bollard light
page 366
733002

item	colour	dimensions L x W x H x Ø	socket L x W x H x Ø	price
731008	<input type="checkbox"/> silver coloured	125 x 60 x 105 x 60 mm	100 x 43 x 22 mm	49,94 €
731009	<input type="checkbox"/> silver coloured	150 x 68 x 106 x 60 mm	150 x 68 x 27 mm motion / twilight sensor	79,95 €



suitable illuminants on page 767



ZILLY II UP AND DOWN + ZILLY II UP AND DOWN MOTION

- stainless steel
- dimmable via optional illuminants [only 731010]

suitable
bollard light
page 366
733003

item	colour	dimensions L x W x H x Ø	socket L x W x H x Ø	price
731010	<input type="checkbox"/> silver coloured	178 x 60 x 105 x 60 mm	102 x 42 x 22 mm	84,95 €
731011	<input type="checkbox"/> silver coloured	220 x 70 x 108 x 60 mm	148 x 67 x 25 mm motion / twilight sensor	99,95 €



suitable illuminants on page 767



NOVA II

- stainless steel
- dimensions L x W x H x Ø: 388 x 145 x 110 x 75 mm
- socket H x Ø: 25 x 110 mm
- motion / twilight sensor
- E27 socket suitable for A19 LED bulb

item	colour	price
730034	■ silver coloured	69,95 €



suitable
bollard light
page 365
730032



FACADO A

- aluminium diecast
- dimensions L x W x H: 243 x 110 x 150 mm
- socket L x W x H: 120 x 90 x 35 mm
- dimmable via optional illuminants

item	colour	price
731059	■ anthracite	99,95 €



suitable illuminants on page 770-771



suitable
bollard lights
page 369
730332
733018



suitable energy
distributor
page 453
733064
733065



ORTIS

- aluminium diecast
- dimensions L x W x H x Ø: 260 x 120 x 181 x 120 mm
- socket L x W x H: 100 x 77 x 67 mm

item	colour	colour temperature	light current	price
731031	■ dark grey	ww 3000 K	510 lm	179,95 €

220-240 Volt	15 W	COB	1 LED	Ra>80	360°	IP54
--------------	------	-----	-------	-------	------	------

suitable
bollard light
page 376
733004





ALBALDAH MOTION

- timeless design
- sophisticated effect lighting
- aluminium diecast
- dimensions L x H: 220 x 120 mm
- motion sensor

item	colour	colour temperature	light current	price
731132	grey	3000 K	645 lm	109,95 €

220-240 Volt	13,5 W	SMD	28 LED	Ra>80	120°	IP65
--------------	--------	-----	--------	-------	------	------





ADEBAR MOTION

- timeless design
- aluminium diecast
- dimensions L x Ø: 218 x 160 mm
- motion sensor

item	colour	price
731137	 grey	99,95 €



suitable illuminants on page 770-771



SAIPH & SARGAS

The classic outdoor luminaires combine proven luminaire design from over 100 years with modern conveniences. The timeless wall-mounted luminaires of the new SAIPH and SARGAS series evoke reminiscences of iconic designs from various decades and impress with high-quality real glass that is not only resistant to scratches but also weather and UV-resistant.



SAIPH

- rustic design
- aluminium
- dimensions L x W x H: 170 x 149 x 280 mm
- dimmable via optional illuminants

item	colour	price
341244	■ black	49,95 €



suitable illuminants on page 770-771



SARGAS

- rustic design
- aluminium
- dimensions L x W x H: 178 x 151 x 318 mm
- dimmable via optional illuminants

item	colour	price
341245	■ black	49,95 €



suitable illuminants on page 770-771





GRUMIUM

Modular, compact, with great effect – GRUMIUM wall-mounted luminaire can be installed on terraces, house walls or in the entrance area of residential environments and, thanks to its optional covers with different designs, is a flexible universal solution for many applications. The permanently installed and energy-saving LEDs with a maximum of 10 watts are surrounded by a diffuser made of milky plastic and produce a pleasant warm white light with a luminous flux of 450 lm. With the GRUMIUM ANGULAR CCT I, even the color temperature can be adjusted between warm white and neutral white via dip switch. The GRUMIUM outdoor luminaire with its die-cast aluminum housing is available in square and rounded versions and has IP54 protection.



GRUMIUM ANGULAR CCT I

- aluminium diecast
- dimensions L x W x H: 100 x 70 x 200 mm
- socket W x H x Ø: 95 x 15 x 195 mm
- light color adjustable via DIP switch

item	colour	colour temperature	light current	price
620123	dark grey borders	ww nw 3000/4000 K	450 lm	99,95 €
620124	dark grey lines diagonal	ww nw 3000/4000 K	205 lm	99,95 €
620125	dark grey lines horizontally	ww nw 3000/4000 K	280 lm	99,95 €
620126	dark grey lines vertical	ww nw 3000/4000 K	300 lm	99,95 €
620127	dark grey upside/below	ww nw 3000/4000 K	440 lm	99,95 €

220-240 Volt	10 W	SMD	64 LED	Ra>80	138°	IP54
--------------	------	-----	--------	-------	------	------



GRUMIUM ROUND I

- aluminium diecast
- dimensions L x W x H: 100 x 70 x 200 mm
- socket W x H x Ø: 95 x 15 x 195 mm

item	colour	colour temperature	light current	price
620128	dark grey upside/below	ww 3000 K	325 lm	99,95 €
620129	dark grey Taille	ww 3000 K	210 lm	99,95 €
620130	dark grey lines horizontally	ww 3000 K	250 lm	99,95 €

100-240 Volt	10 W	SMD	32 LED	Ra80	180°	IP54
--------------	------	-----	--------	------	------	------



BEACON MOTION

- aluminium diecast
- dimensions L x W x H: 250 x 68 x 106 mm
- socket L x W x H: 68 x 68 x 5 mm
- motion / twilight sensor

item	colour	colour temperature	light current	price
731016	■ anthracite	www 3000 K	290 lm	119,95 €

220-240 Volt	6 W	SMD	30 LED	Ra>80	120°		IP44
--------------	-----	-----	--------	-------	------	--	------

suitable
bollard lights
page 375
733006
733008



LACERTAE

- aluminium diecast | glass
- dimensions L x W x H: 180 x 256 x 370 mm
- socket L x W x H: 98 x 30 x 105 mm
- motion sensor

item	colour	colour temperature	light current	price
731112	■ dark grey	www 3000 K	440 lm	189,95 €

110-240 Volt	9 W	SMD	96 LED	Ra>80	120°		IP54
--------------	-----	-----	--------	-------	------	--	------



suitable battery
table light
page 352
346009



LACERTAE

LACERTAE is a light catcher – and guaranteed an eye-catcher. Matching the portable version, the LACERTAE also convinces as a rustic wall lamp including motion detector on brick and natural stone walls.



ALKES

The ALKES series is not a classic wall-mounted luminaire, but with its SMD LED panel is reminiscent of a floodlight. The highlight: the upper part of the housing is tilted forward by 45° from the façade to direct the warm white light specifically onto the surface to be illuminated. In addition, the ALKES with its modern design and rounded edges cuts a great figure even when switched off.



ALKES

- modern design
- high light output
- homogeneous light distribution
- aluminium diecast

item	colour	colour temperature	light current	power	dimensions L x W x H	price
731138	■ dark grey	www 3000 K	920 lm	21 W	200 x 126 x 184 mm	109,95 €
731140	■ dark grey	www 3000 K	1720 lm	36 W	297 x 165 x 240 mm	169,95 €

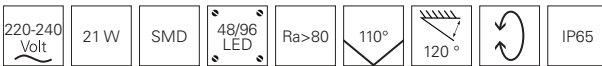

ALKES MOTION

- modern design
- high light output
- homogeneous light distribution
- aluminium diecast
- motion sensor

item	colour	colour temperature	light current	power	dimensions L x W x H	price
731139	■ dark grey	www 3000 K	735 lm	21 W	200 x 126 x 184 mm	129,95 €
731141	■ dark grey	www 3000 K	1720 lm	36 W	297 x 165 x 240 mm	199,95 €

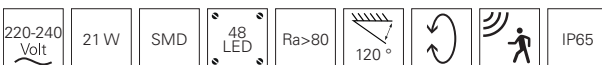



TUCANAE + TUCANAE MOTION

- modern, minimalist design
- brightness threshold and running time adjustable
- aluminium diecast
- dimensions L x W x H: 140 x 172 x 219 mm
- socket L x W x H: 125 x 135 x 15 mm



item	colour	colour temperature	light current	price
731144	■ dark grey	www 3000 K	1650 lm	165,95 €
731133	■ dark grey	www 3000 K	1650 lm motion / twilight sensor	175,95 €

suitable
bollard lights
page 380
733068
733069

110-240 Volt	16 W	SMD	100 LED	Ra>80	110°	IP65
-----------------	------	-----	------------	-------	------	------





reddot award 2017
winner



ROBI FLEX

- aluminium diecast
- dimensions L x W x H: 120 x 45 x 125 mm
- socket L x W: 78 x 45 mm

item	colour	colour temperature	light current	price
731068	■ dark grey	ww 3000 K	700 lm	179,95 €

110-240 Volt	10 W	SMD	48 LED	Ra>80	110°	↻	0-90°	IP54
--------------	------	-----	--------	-------	------	---	-------	------



suitable
bollard light
page 377
733007



IRETTA

- aluminium diecast
- dimensions L x W x H: 150 x 125 x 97,5 mm
- socket L x W: 121 x 93 mm
- motion / twilight sensor

item	colour	colour temperature	light current	price
730395	■ anthracite	ww 3000 K	370 lm	169,95 €

220-240 Volt	6 W	SMD	64 LED	Ra>80	🚶	IP54
--------------	-----	-----	--------	-------	---	------



suitable
bollard light
page 377
730354

ACHERNAR

ACHERNAR with a lot of flexibility: the GU10 base in the simple aluminum die-cast housing allows free choice of illuminant for any application.



ACHERNAR DOWN + UP AND DOWN

- timeless design
- aluminium diecast
- dimmable via optional illuminants

item	colour	power	radiation characteristics	dimensions W x H x Ø	price
731130	■ anthracite	1x max. 50 W	downwards	95 x 108 x 63 mm	39,95 €
731131	■ anthracite	2x max. 35 W	up- / downwards	95 x 158 x 63 mm	52,95 €



suitable illuminants on page 767



MOBBY II

The conversion artist – the cable outlet is not exactly where the light is needed? No problem for the MOBBY II. Thanks to its swiveling head, areas can be illuminated that would otherwise be inaccessible. The MOBBY II is equipped with the powerful and cost-efficient 9 Watt LED module.



MOBBY II

- aluminium diecast
- dimensions H x Ø: 100 x 84 mm
- socket H x Ø: 34 x 95 mm
- dimmable via phase control or phase cut-off
- beam angle can be changed with optional interchangeable reflector

item	colour	colour temperature	light current	price
731021	■ anthracite	ww 3000 K	810 lm	179,95 €

220-240 Volt	9W	COB	1 LED	Ra>80	53°	↻	90°	+ -	IP55
--------------	----	-----	-------	-------	-----	---	-----	-----	------



MOBBY II SINGLE + DOUBLE

- aluminium diecast
- socket L x W x H: 120 x 80 x 34 mm
- beam angle can be changed with optional interchangeable reflector

item	colour	colour temperature	light current	power	radiation characteristics	dimensions L x W x H x Ø	price
731072	■ anthracite	ww 3000 K	810 lm	9 W	downwards	84 x 124 x 120 x 84 mm	179,95 €
731071	■ anthracite	ww 3000 K	1620 lm	19 W	up- / downwards	84 x 124 x 220 x 84 mm	299,95 €

220-240 Volt	COB	1-2 LED	Ra>80	53°	IP55
--------------	-----	---------	-------	-----	------

JABBAH

The square JABBAH uses integrated COB LEDs in warm white and emits its light asymmetrically at 75° in a cone shape onto walls - in the simple version with 915 lumens, as UP AND DOWN version with a total of 1850 lumens. In addition, the double-sided JABBAH can be dimmed to 60% light output via a dip switch if a more discreet light output is desired.



JABBAH + UP AND DOWN

- modern design
- dimmable to 60% via dip switch
- high luminous intensity
- aluminium diecast
- dimensions L x W x H: 150 x 150 x 150 mm

item	colour	colour temperature	light current	power	radiation characteristics	price
731128	■ dark grey	ww 3000 K	915 lm	13 W	downwards	229,95 €
731127	■ dark grey	ww 3000 K	1850 lm	25 W	up- / downwards	299,95 €

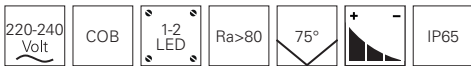

CUBODO

- aluminium diecast
- dimensions L x W x H: 90 x 110 x 90 mm
- socket L x W x H: 59 x 59 x 20 mm

item	colour	colour temperature	light current	price
730380	□ white	ww 3000 K	270 lm	119,95 €
730329	■ brown	ww 3000 K	270 lm	119,95 €
730328	■ anthracite	ww 3000 K	270 lm	119,95 €

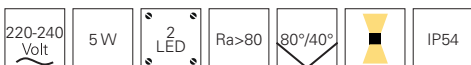



CUBODO II SINGLE + DOUBLE

- aluminium diecast
- dimensions L x W x H: 108 x 108 x 115 mm
- socket L x W: 108 x 108 mm

item	colour	colour temperature	light current	power	radiation characteristics	price
731026	white	3000 K	600 lm	7 W	downwards	149,95 €
731025	silver coloured	3000 K	600 lm	7 W	downwards	149,95 €
731024	dark grey	3000 K	600 lm	7 W	downwards	149,95 €
731020	white	3000 K	1260 lm	14 W	up- / downwards	169,95 €
731019	silver coloured	3000 K	1260 lm	14 W	up- / downwards	169,95 €
731015	dark grey	3000 K	1260 lm	14 W	up- / downwards	169,95 €



CUBODO II SINGLE DG MINI + DOUBLE DG MINI

- aluminium diecast
- socket L x W x H: 65 x 65 x 20 mm

item	colour	colour temperature	light current	power	radiation characteristics	dimensions L x W x H	price
731029	dark grey	3000 K	220 lm	4,50 W	downwards	90 x 68 x 70 mm	109,95 €
731030	dark grey	3000 K	440 lm	9,00 W	up- / downwards	90 x 68 x 108 mm	139,95 €





ARCTURUS

The ARCTURUS LED wall-mounted luminaire presents itself in a modern cube design [also available in an elongated form] and is suitable for flexible lighting in outdoor areas. The beam angle of the IP54 luminaire can be adjusted between 0° and 90° via an integrated shutter to generate a different light pattern depending on the application requirements. Protected in the dark grey die-cast aluminium housing are the two high-power LEDs that produce a warm white, 5.5 W light.



ARCTURUS I

- aluminium diecast
- dimensions L x W x H: 79 x 110 x 172 mm
- socket L x W x H: 68 x 110 x 110 mm
- adjustable beam angle

item	colour	colour temperature	light current	price
731099	■ dark grey	ww 3000 K	200 lm	104,95 €

220-240 Volt	5,50 W	2 LED	Ra>80	0-90°		IP54
--------------	--------	-------	-------	-------	--	------



ARCTURUS II

- aluminium diecast
- dimensions L x W x H: 140 x 105 x 145 mm
- socket L x W x H: 75 x 100 x 120 mm
- adjustable beam angle

item	colour	colour temperature	light current	price
731100	■ dark grey	ww 3000 K	200 lm	104,95 €

220-240 Volt	5,50 W	2 LED	Ra>80	0-90°		IP54
--------------	--------	-------	-------	-------	--	------

KIMBALI ANGULAR

- aluminium
- dimensions L x W x H: 160 x 90 x 50 mm
- socket L x W: 148 x 85 mm



item	colour	colour temperature	light current	price
731014	■ anthracite	www 3000 K	370 lm	109,95 €



AGUDO II SINGLE + DOUBLE

- aluminium diecast
- socket L x W: 75 x 75 mm

item	colour	colour temperature	light current	power	radiation characteristics	dimensions L x W x H	price
730381	■ anthracite	www 3000 K	70 lm	2 W	downwards	63 x 80 x 75 mm	64,95 €
730382	■ anthracite	www 3000 K	140 lm	3 W	up- / downwards	140 x 80 x 65 mm	89,95 €

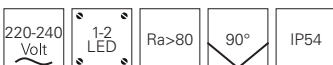



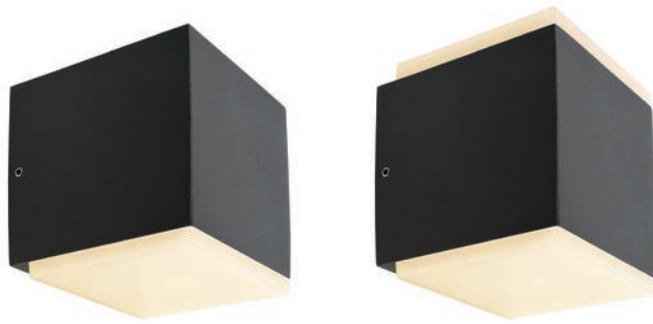

ANCHA I + II

- aluminium diecast
- socket L x W x H: 74 x 12 x 83 mm

item	colour	colour temperature	light current	power	radiation characteristics	dimensions L x W x H	price
731087	■ dark grey	☀ 3000 K	260 lm	5,50 W	downwards	80 x 92 x 97 mm	89,95 €
731088	■ dark grey	☀ 3000 K	530 lm	10,00 W	up- / downwards	80 x 92 x 105 mm	119,95 €

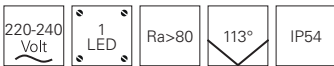

CUBE

- aluminium diecast
- dimensions L x W x H: 70 x 120 x 60 mm
- socket L x W: 70 x 60 mm

item	colour	colour temperature	light current	price
730355	■ anthracite	☀ 2700 K	400 lm	149,95 €





RILONGO

- aluminium diecast
- dimensions L x W x H: 250 x 110 x 103 mm
- socket L x W: 250 x 110 mm
- dimmable via optional illuminants

item	colour	price
730330	■ anthracite	74,95 €
730331	■ brown	74,95 €



suitable illuminants on page 770-771

WALL LINE III

- aluminium diecast
- dimensions L x W x H: 250 x 110 x 110 mm
- socket L x W: 250 x 103 mm
- dimmable via optional illuminants

item	colour	price
731060	■ anthracite	74,95 €



suitable illuminants on page 770-771





LINEAR I SINGLE + LINEAR II DOUBLE

- aluminium diecast
- socket L x W x H: 242 x 53 x 15 mm

item	colour	colour temperature	light current	radiation characteristics	power	dimensions H x T x B	price
731135	■ dark grey	☀ 3000 K	600 lm	downwards	8,5 W	60 x 60 x 250 mm	145,95 €
731134	■ dark grey	☀ 3000 K	1230 lm	downwards	14,0 W	60 x 60 x 500 mm	189,95 €
731136	■ dark grey	☀ 3000 K	1155 lm	down- / upwards	14,0 W	60 x 60 x 250 mm	179,95 €
731129	■ dark grey	☀ 3000 K	1760 lm	down- / upwards	20,0 W	60 x 60 x 500 mm	209,95 €

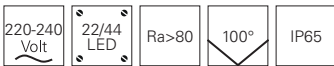

URIA 10

- aluminium diecast
- dimensions L x W x H: 300 x 97 x 120 mm
- socket L x W x H: 270 x 20 x 85 mm

item	colour	colour temperature	light current	price
731033	■ anthracite	☀ 3000 K	408 lm	109,95 €



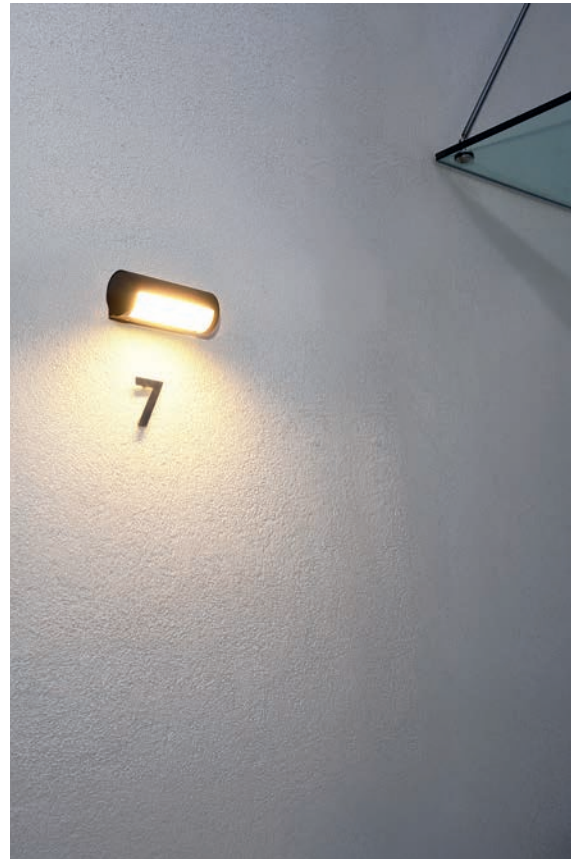

SEGIN

The SEGIN LED wall-mounted luminaire is suitable for versatile outdoor use and illuminates outdoor and entrance areas of buildings and can also be used as a house number luminaire if required. In addition to the robust die-cast aluminium housing, the SEGIN also has a round shutter that allows the direction of light to be flexibly adjusted to the respective application.



SEGIN

- adjustable bezel
- aluminium diecast
- dimensions L x W x H x Ø: 223 x 130 x 105 x 105 mm
- socket L x W x H: 185 x 63 x 30 mm

item	colour	colour temperature	light current	price
731118	■ anthracite	■ 3000 K	370 lm	129,95 €

100-240 Volt	13 W	SMD	12 LED	Ra>80	90°	IP65
--------------	------	-----	--------	-------	-----	------

BERMUDA

Admittedly, a big name for a small luminaire. But in its design, the BERMUDA series is undoubtedly just as exciting as the well-known triangle. The small light dwarf is an enrichment for every garden and fits like a small mushroom into every outdoor environment. And by the way, it also cuts a fine figure as a wall luminaire.



BERMUDA

- design by Johannes Tomm
- eyecatcher outdoor lighting
- 360° beam angle
- aluminium diecast
- dimensions H x Ø: 142 x 200 mm
- socket H x Ø: 79 x 70 mm
- dimmable via phase control or phase cut-off

item	colour	colour temperature	light current	price
731124	■ anthracite	ww 3000 K	600 lm	129,95 €

220-240 Volt	10 W	SMD	72 LED	Ra>80	360°		IP65
--------------	------	-----	--------	-------	------	--	------



suitable
bollard light
page 382
733056



suitable
ground spike
lights
IP65
page 456
733060
733059



suitable
wall lights
page 170
342159
342160



suitable
table and
floor lights
page 212/213
346018
346017
343029
343028

CHERTAN

With its unusual material mix of die-cast aluminium housing and a concrete base, the CHERTAN outdoor wall luminaire stands out visually from other models. With its pleasant warm white light and a beam angle of 120° including motion and twilight switch, the outdoor luminaire is perfect for decorative use in entrance areas.



CHERTAN

- aluminium diecast | concrete
- dimensions L x W x H: 170 x 90 x 302 mm
- socket L x W x H: 110 x 22 x 800 mm
- motion / twilight sensor

item	colour	colour temperature	light current	price
731113	■ anthracite, concrete	ww 3000 K	570 lm	179,95 €

100-277 Volt	13,50 W	SMD	72 LED	Ra>90	120°	IP54
--------------	---------	-----	--------	-------	------	------

suitable
bollard lights
page 372
733043
733044
733045



LYNCIS

The LYNCS LED wall-mounted luminaire not only impresses with its sophisticated and filigree design [winner of the Red Dot Design Award 2017], but also with its outdoor properties. The compact IP65-certified outdoor luminaire sits in a dark grey die-cast aluminium housing and with its 96 LEDs produces a 10-watt, warm white light [500 lm] that integrates seamlessly into a wide range of outdoor applications.



reddot award 2017
winner



LYNCIS

- aluminium diecast
- dimensions L x W x H: 300 x 142 x 315 mm
- socket L x W x H: 95 x 95 x 18 mm

item	colour	colour temperature	light current	price
731102	■ dark grey	■ 3000 K	500 lm	135,95 €

220-240 Volt	10 W	SMD	96 LED	Ra>80	170°	IP65
--------------	------	-----	--------	-------	------	------





VOLANTIS

- aluminium diecast
- dimensions L x W x H: 300 x 300 x 47 mm
- socket L x W x H: 165 x 165 x 25 mm

item	colour	colour temperature	light current	price
731109	■ dark grey	ww 3000 K	1300 lm	229,95 €

110-240 Volt	16 W	SMD	100 LED	Ra>80	120°		IP65
--------------	------	-----	---------	-------	------	---	------





GIANFAR







The elegant GIANFAR outdoor wall light convinces with a classic and expressive design. Practical: The sticker set included in the scope of delivery allows you to quickly and easily transform the GIANFAR into a house number light if required.



GIANFAR

- aluminium diecast
- dimensions L x W x H: 161 x 59 x 211 mm
- socket L x W x H: 145 x 17 x 73 mm
- suitable as house number light

item	colour	colour temperature	light current	price
731119	 dark grey	 3000 K	930 lm	115,95 €

 100-240 Volt	 12 W	 SMD	 60 LED	 Ra>80	 120°	 IP54
--	--	---	--	---	--	--



accessories

948139 numbers set | numbers each 3x [0 to 9] and letters each 1x [A to J]

8,95 €



□ ■ □
page 426



□ ■
page 426



□ □
page 427



□ ■
page 427



■ □
page 428



■ □
page 428



■ □
page 429



ceiling and wall lights





MOB ROUND I + SQUARE II

- aluminium diecast
- dimmable via optional illuminants

item	colour	dimensions H x Ø / L x W x H	price
730407	□ white	92 x 108 mm	69,95 €
730408	■ anthracite	92 x 108 mm	69,95 €
730409	□ white	108 x 108 x 100 mm	81,95 €
730410	■ anthracite	108 x 108 x 100 mm	81,95 €



suitable illuminants on page 774



CETI

- aluminium diecast
- dimensions L x W x H: 85 x 85 x 99 mm
- dimmable via phase control or phase cut-off

item	colour	colour temperature	light current	price
348045	□ white	ww 3000 K	730 lm	179,95 €
348046	■ black	ww 3000 K	730 lm	169,95 €





SCUTI I + II

- stainless steel
- dimmable via optional illuminants

item	colour	dimensions H x Ø / L x W x H	price
731053	<input type="checkbox"/> silver coloured brushed	85 x 285 mm	79,95 €
731052	<input type="checkbox"/> silver coloured brushed	285 x 285 x 85 mm	79,95 €



suitable illuminants on page 770-771



AURIGAE

- aluminium diecast
- dimensions L x W x H: 250 x 250 x 60 mm
- socket L x W x H: 190 x 190 x 20 mm

item	colour	colour temperature	light current	price
348121	<input type="checkbox"/> white	<input checked="" type="checkbox"/> 3000 K	1550 lm	119,95 €
348120	<input checked="" type="checkbox"/> anthracite	<input checked="" type="checkbox"/> 3000 K	1550 lm	119,95 €





ASCELLA + ARNEB

- aluminium diecast
- socket H x Ø: 12 x 270 mm

item	colour	colour temperature	light current	dimensions H x Ø / L x W x H	price
348069	■ dark grey	ww 3000 K	2300 lm	50 x 340 mm	229,95 €
348070	■ dark grey	ww 3000 K	2300 lm	340 x 340 x 50 mm	229,95 €



QUADRATA I + II + III

- plastic

item	colour	colour temperature	light current	power	dimensions L x W x H	socket L x W x H	price
348011	■ grey	ww 3000 K	680 lm	10 W	220 x 220 x 56 mm	190 x 190 x 10 mm	109,95 €
348009	■ grey	ww 3000 K	1110 lm	16 W	296 x 296 x 78 mm	230 x 230 x 10 mm	119,95 €
348007	■ grey	ww 3000 K	1280 lm	20 W	400 x 400 x 93 mm	312 x 312 x 10 mm	169,95 €





MENSAE ROUND + ANGULAR

item	colour	colour temperature	light current	dimensions H x Ø / L x W x H	price
348072	■ dark grey	ww 3000 K	1340 lm	48 x 300 mm	229,95 €
348071	■ dark grey	ww 3000 K	1240 lm	300 x 300 x 48 mm	229,95 €

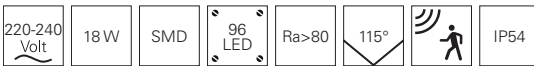



□
page 432



□
page 432



□ ■
page 434



□ ■
page 434



□ ■
page 434



□ □ ■
page 437



□ □ ■
page 437



□ □ ■
page 437



□ □ ■
page 437



□ ■ ■
page 439



□ ■ ■
page 439



□ ■ ■
page 439



□ ■ ■
page 439



built in wall lights





SIDE II WW

- aluminium diecast
- dimensions L x W x H: 171 x 106 x 65 mm
- dimmable via optional illuminants

item	colour	price
100028	silver coloured	79,95 €

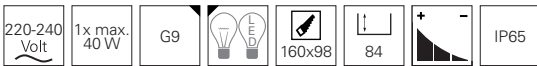

suitable illuminants on page 766



SIDE III LED RGB

- aluminium diecast
- dimensions L x W x H: 171 x 106 x 65 mm
- dimmable via optional controller

item	colour	colour temperature	light current	price
100238	silver coloured	RGB	24 lm	109,95 €



accessories

872083	power supply 24V 40,0 W IP67	79,95 €
843058	RF RGB Controller Set dimmable 12/24/48V DC	114,95 €

With the kind support of Loxone Lichtinstallation Eurotec-lbiza@fotoeichhorn





YVETTE I

- aluminium diecast
- dimensions L x W x H: 107 x 75 x 64,5 mm

item	colour	colour temperature	light current	price
763005	white	3000 K	108 lm	79,95 €
763004	anthracite	3000 K	75 lm	79,95 €

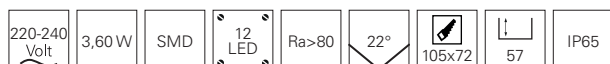

YVETTE II

- aluminium diecast
- dimensions L x W x H: 75 x 105 x 64,5 mm

item	colour	colour temperature	light current	price
763007	white	3000 K	130 lm	79,95 €
763006	anthracite	3000 K	100 lm	79,95 €

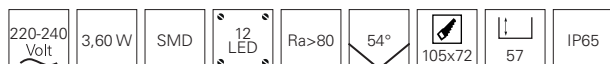

YVETTE III

- aluminium diecast
- dimensions L x W x H: 250 x 87 x 73 mm

item	colour	colour temperature	light current	price
763012	white	3000 K	335 lm	139,95 €
763011	anthracite	3000 K	219 lm	139,95 €

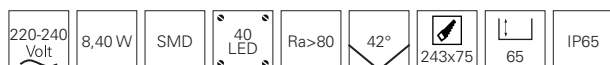



LIGHT BASE II COB OUTDOOR

Recessed wall luminaires in outdoor areas have a slim and elegant appearance and set the scene as light accents for buildings, paths and more. To ensure that the light emission perfectly matches the surroundings, you can choose between four optional cover types and three housing colors each [black, grey, white] for the LIGHT BASE II COB OUTDOOR: stepped, stripe, linear and round. Each shape creates a different light output, allowing for flexible design of outdoor areas.



LIGHT BASE II COB OUTDOOR

- aluminium diecast
- dimensions L x H x W x H: 96 x 96 x 77 mm
- IP65 screwed cable gland
- excl. cover

item	colour	colour temperature	light current	price
763025	■ grey	www 3000 K	55 lm	99,95 €

220-240 Volt	1 W	COB	1 LED	Ra>80	36°	95x95	70	IP67
--------------	-----	-----	-------	-------	-----	-------	----	------



With the kind support of Loxone Lichtinstallation Eurotec-Ibiza@fotoeichhorn



cover

930416	<input type="checkbox"/> cover angular step white	100 x 100 x 24 mm	18,95 €
930417	<input type="checkbox"/> cover angular step grey	100 x 100 x 24 mm	18,95 €
930418	<input type="checkbox"/> cover angular step black	100 x 100 x 24 mm	18,95 €
930419	<input type="checkbox"/> cover angular stripe white	100 x 100 x 24 mm	18,95 €
930414	<input type="checkbox"/> cover angular stripe grey	100 x 100 x 24 mm	18,95 €
930420	<input type="checkbox"/> cover angular stripe black	100 x 100 x 24 mm	18,95 €
930421	<input type="checkbox"/> cover angular linear white	100 x 100 x 24 mm	18,95 €
930422	<input type="checkbox"/> cover angular linear grey	100 x 100 x 24 mm	18,95 €
930415	<input type="checkbox"/> cover angular linear black	100 x 100 x 24 mm	17,95 €
930413	<input type="checkbox"/> cover angular round white	100 x 100 x 24 mm	18,95 €
930423	<input type="checkbox"/> cover angular round grey	100 x 100 x 24 mm	17,95 €
930424	<input type="checkbox"/> cover angular round black	100 x 100 x 24 mm	18,95 €

LIGHT BASE III OUTDOOR

Recessed wall luminaires in outdoor areas have a slim and elegant appearance and set the scene as light accents for buildings, paths and more. To ensure that the light emission perfectly matches the surroundings, you can choose between four optional cover types and three housing colours each [black, grey, white] for the LIGHT BASE III OUTDOOR: stepped, stripe, angled and rounded angled. Each shape creates a different light output, allowing for flexible design of outdoor areas.



LIGHT BASE III OUTDOOR

- aluminium diecast
- dimensions L x H x W x H: 245 x 85 x 78 mm
- IP65 screwed cable gland
- excl. cover

item	colour	colour temperature	light current	price
763026	■ black	www 3000 K	88 lm	139,95 €

220-240 Volt	4 W	SMD	1 LED	Ra>90	115°	245x85	78	IP67
--------------	-----	-----	-------	-------	------	--------	----	------



With the kind support of Loxone Lichtinstallation Eurotec-Ibiza@fotoeichhorn

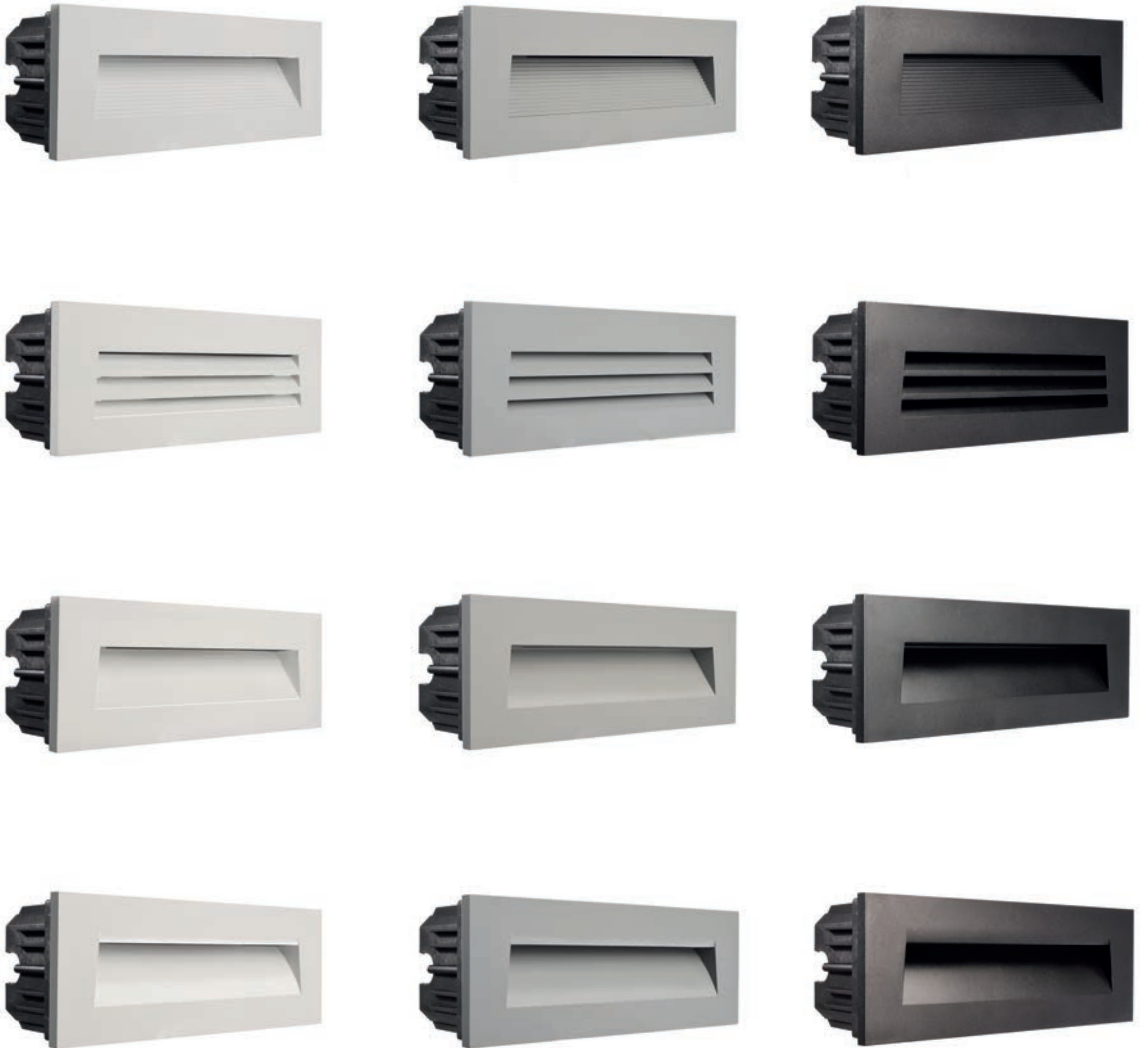

cover

930461	 cover step white	250 x 90 x 24 mm	62,95 €
930468	 cover step grey	250 x 90 x 24 mm	62,95 €
930469	 cover step black	250 x 90 x 24 mm	62,95 €
930470	 cover stripe white	250 x 90 x 24 mm	62,95 €
930471	 cover stripe grey	250 x 90 x 24 mm	62,95 €
930472	 cover stripe black	250 x 90 x 24 mm	62,95 €
930473	 cover angled white	250 x 90 x 24 mm	62,95 €
930474	 cover angled grey	250 x 90 x 24 mm	62,95 €
930475	 cover angled black	250 x 90 x 24 mm	62,95 €
930476	 cover rounded white	250 x 90 x 24 mm	62,95 €
930477	 cover rounded grey	250 x 90 x 24 mm	62,95 €
930478	 cover rounded black	250 x 90 x 24 mm	62,95 €



□ □
page 442



■ ■ □
page 443



■ □
page 443



■
page 444



■
page 444



■
page 445



spherical and floor lamps





SPHERICAL LAMP

- polyethylene [LLDPE]
- dimmable via optional illuminants
- ready to plug in with IP44 safety plug
- incl. ground spike

item	colour	dimensions Ø	power	price
836011	<input type="checkbox"/> white	300 mm	max. 20 W	139,95 €
836930	<input type="checkbox"/> white	400 mm	max. 42 W	169,59 €
836014	<input type="checkbox"/> white	500 mm	max. 42 W	199,95 €
836931	<input type="checkbox"/> white	600 mm	max. 42 W	319,95 €
836958	<input type="checkbox"/> white	800 mm	max. 42 W	519,25 €



suitable illuminants on page 770-773

suitable energy distributors/plug-in socket towers on page 449-453





SPHERICAL LAMP GRANITE + TERRACOTTA

- polycresin
- dimmable via optional illuminants
- ready to plug in with IP44 safety plug
- incl. ground spike

item	colour	dimensions Ø	power	price
836012	■ granite optic	300 mm	max. 20 W	139,95 €
836934	■ granite optic	400 mm	max. 42 W	169,59 €
836015	■ granite optic	500 mm	max. 42 W	199,95 €
836935	■ granite optic	600 mm	max. 42 W	319,95 €
836960	■ granite optic	800 mm	max. 42 W	519,25 €
836013	■ Terracotta	300 mm	max. 20 W	139,95 €
836961	■ Terracotta	400 mm	max. 42 W	169,59 €
836016	■ Terracotta	500 mm	max. 42 W	199,95 €
836962	■ Terracotta	600 mm	max. 42 W	319,95 €
836963	■ Terracotta	800 mm	max. 42 W	519,25 €



suitable illuminants on page 770-773
 suitable energy distributors/plug-in socket towers on page 449-453



BOOTIS I + II

- aluminium diecast

item	colour	colour temperature	light current	dimensions L x W x H	socket L x W x H	power	light source	price
733032	■ anthracite	☀ 3000 K	700 lm	150 x 150 x 161 mm	140 x 140 x 20 mm	12 W	12 LED	94,95 €
733027	■ anthracite	☀ 3000 K	1100 lm	250 x 250 x 270 mm	240 x 240 x 35 mm	20 W	1 LED	159,95 €

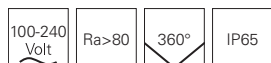

suitable mounting accessories for outdoor use from page 800

VELORUM

Flexible outdoor luminaires, ready to plug in for any application, that is what the VELORUM series is all about. With its three versions - floor, table and pendant luminaire – it brings a living room atmosphere into your garden. Due to its robust design, it can withstand a lot and is thus the ideal party lighting.

VELORUM

- plastic
- dimensions H x Ø: 510 x 224 mm
- socket H x Ø: 8 x 230 mm
- incl. 3 m connection cable with IP44 connector plug

item	colour	price
836019	 anthracite	169,95 €



suitable illuminants on page 770-771

suitable energy distributors/plug-in socket towers on page 449-453



VELORUM

- plastic
- dimensions H x Ø: 1450 x 345 mm
- socket H x Ø: 10 x 300 mm
- incl. 3 m connection cable with IP44 connector plug

item	colour	price
836018	 anthracite	219,95 €



suitable illuminants on page 770-771

suitable energy distributors/plug-in socket towers on page 449-453





VELORUM

- plastic
- dimensions H x Ø: 254 x 290 mm
- max. suspension: 1,00 m
- incl. 2,5 m connection cable with IP44 connector plug

item	colour	price
836020	 anthracite	139,95 €



suitable illuminants on page 770-771





■ page 449



■ page 449



■ page 450



■ page 451



■ □ page 453



energy distributor





SOCKET TOWER

Sometimes it takes a little more than simply »just« light. With our socket tower, available with and without light, we are closing another gap in our range. Make your garden even more flexible – of course in proven DEKO-LIGHT quality at a fair price.

SOCKET TOWER

- aluminium diecast
- dimensions L x H x Ø: 400 x 100 mm
- incl. 2 outlets [total load max. 3650 W]

item	colour	price
733055	■ dark grey	119,95 €



suitable mounting accessories for outdoor use from page 800



SOCKET TOWER ILLUMINATED

- aluminium diecast
- dimensions L x H x Ø: 478 x 100 mm
- luminaire can be switched separately
- incl. 2 outlets [total load max. 3650 W]

item	colour	colour temperature	light current	price
733054	■ dark grey	■ 3000 K	150 lm	179,95 €



suitable mounting accessories for outdoor use from page 800



PUKA MANA + KUKUI PUKA

A garden is pure nature – and yet it needs electricity in many places. With the new PUKA MANA, you can flexibly tap power to operate lawn mowers and other garden tools or simply charge your e-bike or smartphone. The KUKUI PUKA puts the [light] crown on the whole thing and provides thanks to E27-socket for changeable lighting moods. Both models have two socket locations and are particularly easy to install using our multi-outdoor cable connectors. In addition, the well thought-out cable routing ensures a clean look.

PUKA MANA

- aluminium diecast
- dimensions L x W x H : 100 x 100 x 420 mm
- socket L x W: 140 x 140 mm
- incl. 2 outlets [total load max. 3650 W]
- door can be fully closed with angled plug inserted

item	colour	price
733066	 dark grey	209,95 €



suitable mounting accessories for outdoor use from page 800



KUKUI PUKA

- aluminium diecast
- dimensions L x W x H : 100 x 100 x 620 mm
- socket L x W: 140 x 140 mm
- luminaire can be switched separately
- incl. 2 outlets [total load max. 3650 W]
- door can be fully closed with angled plug inserted

item	colour	colour temperature	price
733067	■ dark grey	■ ww	269,95 €



suitable illuminants on page 770-771

suitable mounting accessories for outdoor use from page 800





FACADO SOCKET

The floor lamps of the FACADO series have already been used for some time on paved walkways in the garden area. Now the classically elegant outdoor lights become even more versatile: the FACADO SOCKET includes two socket locations and thus also functions as a practical power distributor in the garden, on terraces or on walkways. In addition, thanks to the E27 socket, the light source can be changed and adapted to the desired lighting mood. The FACADO SOCKET is available in two height versions [65 and 100 cm].



FACADO SOCKET

- aluminium diecast
- luminaire can be switched separately
- incl. 2 outlets [total load max. 3650 W]

item	colour	dimensions L x W x H	price
733064	■ anthracite	108 x 108 x 650 mm	209,95 €
733065	■ anthracite	108 x 108 x 1000 mm	229,95 €



suitable illuminants on page 770-771
 suitable mounting accessories for outdoor use from page 800



suitable
 wall light
 page 392
731059



suitable
 bollard lights
 page 269
730332
733018



□ ■
page 456



■
page 457



□ ■ □
page 458



□
page 458



■ □
page 459



■ □
page 459



■
page 461



■
page 461



■ □
page 462



■ □
page 463



■ □
page 464



■ □
page 465



■
page 466



■
page 466



■
page 467



■ □
page 467



surface mounted / ground spike lights



BERMUDA

Admittedly, a big name for a small luminaire. But in its design, the BERMUDA series is undoubtedly just as exciting as the well-known triangle. The small light dwarf is an enrichment for every garden and fits like a small mushroom into every outdoor environment. And by the way, it also cuts a fine figure as a wall luminaire.



BERMUDA

- design by Johannes Tomm
- eyecatcher outdoor lighting
- simple mounting
- 360° beam angle
- aluminium diecast
- dimensions H x Ø: 563 x 200 mm
- dimmable via phase control or phase cut-off
- ready to plug in with IP44 safety plug

item	colour	colour temperature	light current	price
733060	□ white	ww 3000 K	710 lm	199,95 €
733059	■ anthracite	ww 3000 K	710 lm	199,95 €

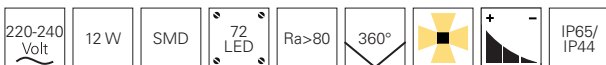

suitable energy distributors/plug-in socket towers on page 449-453



suitable
wall light
IP65
page 418
731124



suitable
bollard light
IP65
page 382
733056



suitable
wall lights
page 170
342159
342160



suitable
table and
floor lights
page 212/213
346018
346017
343029
343028



LOMI

- aluminium
- dimensions L x Ø: 65 x 100 mm
- dimmable via optional illuminants
- incl. 2 m connection cable with IP44 connector plug
- incl. ground spike

item	colour	price
732126	■ black	49,95 €



suitable illuminants on page 767

suitable energy distributors/plug-in socket towers on page 449-453



MINI IWW + I AMBER

- aluminium diecast
- dimensions W x H x Ø: 85 x 85 x 42 mm
- socket H x Ø: 10 x 66 mm
- dimmable via optional controller
- incl. 2 m connection cable with WEIPU plug

item	colour	colour temperature	light current	power	Ra	price
131005	silver coloured	3000 K	150 lm	2,60 W	>80	119,95 €
732036	black	3000 K	150 lm	3,10 W	>80	119,95 €
732037	silver coloured	1750 K	57 lm	2,20 W		119,95 €
730238	black	1700 K	65 lm	2,20 W		119,95 €



accessories

862230 power supply | 24V | 12,0 W | IP65 **24,95 €**

suitable Weipu cables/connectors on page 791-793

suitable controllers and dimmers from page 735

additional power supplies from page 698

MINI II CW

- aluminium diecast
- dimensions W x H x Ø: 85 x 85 x 42 mm
- socket Ø: 66 mm
- incl. 2 m connection cable with IP44 connector plug



item	colour	colour temperature	light current	price
131006	silver coloured	6000 K	180 lm	129,95 €

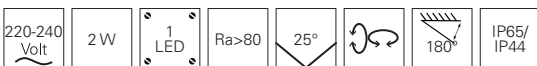

suitable energy distributors/plug-in socket towers on page 449-453

suitable mounting accessories for outdoor use from page 800



KEID

- aluminium diecast
- dimensions L x H x Ø: 120 x 211 x 75 mm
- socket H x Ø: 37 x 99 mm

item	colour	colour temperature	light current	power	price
731098	■ dark grey	www 3000 K	800 lm	10 W	149,95 €
732093	■ dark grey	www 3000 K	1350 lm	20 W	149,95 €



suitable mounting accessories for outdoor use from page 800



KEID II

- aluminium diecast
- dimensions L x H x Ø: 120 x 457 x 75 mm
- incl. IP65 connection box

item	colour	colour temperature	light current	power	price
732094	■ dark grey	www 3000 K	800 lm	10 W	139,95 €
732095	■ dark grey	www 3000 K	1350 lm	20 W	149,95 €



suitable mounting accessories for outdoor use from page 800



COLT

The new COLT series is a real all-rounder in the outdoor area: powerful, freely rotatable and tiltable and equipped with state-of-the-art LED technology. The surface-mounted luminaires thus provide atmospheric lighting concepts in any outdoor installation and also cut a good figure when switched off with their striking design.

COLT 4W COB

- aluminium diecast
- dimensions L x H x Ø: 65 x 120 x 50 mm
- socket H x Ø: 3 x 65 mm
- incl. 2 m connection cable with IP44 connector plug
- incl. 2 glass panes [transparent, milky]
- incl. 1 honeycomb filter



item	colour	colour temperature	light current	price
732104	■ anthracite	www 3000 K	240 lm	139,95 €

220-240 Volt	4 W	COB	1 LED	Ra>80	36°	↻	180°	+ -	IP65/ IP44
--------------	-----	-----	-------	-------	-----	---	------	-----	---------------

accessories

930426	ground spike L: 170 mm	9,95 €
930428	lens 15°	5,95 €
930430	lens 60°	5,95 €

suitable energy distributors/plug-in socket towers on page 449-453
 suitable mounting accessories for outdoor use from page 800

COLT COB RGBW

- aluminium diecast
- dimensions L x Ø: 65 x 50 mm
- socket H x Ø: 7 x 65 mm
- dimmable via optional controller
- incl. 2 m connection cable with WEIPU plug



item	colour	colour temperature	light current	price
732134	■ anthracite	RGB www 2700 K	92 lm	199,95 €

24 Volt	3,2 W	1 LED	Ra>80	20°	↻	45°	IP65
---------	-------	-------	-------	-----	---	-----	------

accessories

862230	power supply 24V 12,0 W IP65	24,95 €
---------------	------------------------------------	----------------

suitable Weipu cables/connectors on page 791-793
 suitable controllers and dimmers from page 735
 additional power supplies from page 698



COLT 8W COB + 8W RGBW

- aluminium diecast
- dimensions L x H x Ø: 65 x 185 x 76,50 mm
- socket H x Ø: 50 x 95 mm
- incl. 2 glass panes [transparent, milky]
- incl. 1 honeycomb filter [only for 732108]

item	colour	colour temperature	light current	beam angle	Ra	voltage	power	price
732108	■ anthracite	3000 K	470 lm	40°	>80	220-240V AC	8,00 W	199,95 €
732127	■ anthracite	3000 K	389 lm	20°		24V DC	8,60 W	299,95 €
732123	■ anthracite	5500 K	485 lm	20°		24V DC	8,60 W	299,95 €

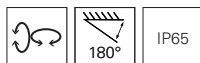

accessories

930441	housing H: 41,5 mm	59,95 €
930426	ground spike L: 170 mm	9,95 €

suitable mounting accessories for outdoor use from page 800

accessories for **732108**

930431	reflector 12°	8,95 €
930432	reflector 22°	8,95 €
930587	connection cable 2950 mm with IP44 230V mains plug	21,95 €

suitable energy distributors/plug-in socket towers on page 449-453

accessories for **732127, 732123**

862230	power supply 24V 12,0 W IP65	24,95 €
872083	power supply 24V 40,0 W IP67	79,95 €

suitable controllers and dimmers from page 735
 additional power supplies from page 698



COLT 15W COB + 16W RGBW

- aluminium diecast
- dimensions L x H x Ø: 88 x 220 x 110,50 mm
- socket H x Ø: 56 x 120 mm
- incl. 2 glass panes [transparent, milky]
- incl. 1 honeycomb filter [only for 732109]

item	colour	colour temperature	light current	beam angle	Ra	voltage	power	price
732109	■ anthracite	3000 K	1090 lm	40°	>80	220-240V AC	15 W	249,95 €
732128	■ anthracite	3000 K	780 lm	20°		24V DC	16 W	449,95 €
732124	■ anthracite	5500 K	950 lm	20°		24V DC	16 W	449,95 €

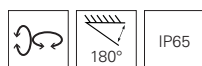

accessories

930442	housing H: 41,5 mm	69,95 €
930427	ground spike L: 219 mm	11,95 €

suitable mounting accessories for outdoor use from page 800

accessories for **732109**

930434	reflector 12°	10,95 €
930435	reflector 22°	11,95 €
930587	connection cable 2950 mm with IP44 230V mains plug	21,95 €

suitable energy distributors/plug-in socket towers on page 449-453

accessories for **732128, 732124**

872083	power supply 24V 40,0 W IP67	79,95 €
---------------	------------------------------------	----------------

suitable controllers and dimmers from page 735
 additional power supplies from page 698



COLT 30W COB + 25W RGBW

- aluminium diecast
- dimensions L x H x Ø: 112 x 260 x 131 mm
- socket H x Ø: 56 x 120 mm
- incl. 2 glass panes [transparent, milky]
- incl. 1 honeycomb filter [only for 732110]

item	colour	colour temperature	light current	beam angle	Ra	voltage	power	price
732110	■ anthracite	3000 K	2320 lm	40°	>80	220-240V AC	30 W	289,95 €
732129	■ anthracite	3000 K	1140 lm	20°		24V DC	25 W	499,95 €
732125	■ anthracite	5500 K	1445 lm	20°		24V DC	25 W	499,95 €

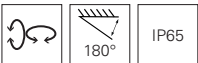

accessories

930442	housing H: 41,5 mm	69,95 €
930427	ground spike L: 219 mm	11,95 €

suitable mounting accessories for outdoor use from page 800

accessories for **732110**

930437	reflector 12°	12,95 €
930438	reflector 22°	19,95 €
930587	connection cable 2950 mm with IP44 230V mains plug	21,95 €

suitable energy distributors/plug-in socket towers on page 449-453

accessories for **732129, 732125**

872083	power supply 24V 40,0 W IP67	79,95 €
872094	power supply 24V 100,0 W IP67	119,95 €

suitable controllers and dimmers from page 735
 additional power supplies from page 698



COLT 65W COB + 36W RGBWW

- aluminium diecast
- dimensions L x H x Ø: 162 x 192 x 182 mm
- socket H x Ø: 65 x 160 mm

item	colour	colour temperature	light current	beam angle	Ra	voltage	power	price
732136	■ anthracite	www 3000 K	5260 lm	15°	>90	180-264V AC	65 W	559,95 €
732137	■ anthracite	RGB www 2700 K	1500 lm	20°	>80	24V DC	30 W	679,95 €

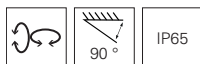

accessories for **732136**

930567	reflector 30°	35,95 €
930568	reflector 45°	35,95 €
930569	reflector 70°	35,95 €
930587	connection cable 2950mm with IP44 230V mains plug	21,95 €

suitable energy distributors/plug-in socket towers on page 449-453

accessories for **732137**

930558	housing H: 40,0 mm	89,95 €
930427	ground spike L: 219 mm	11,95 €
872083	power supply 24V 40,0 W IP67	79,95 €
872094	power supply 24V 100,0 W IP67	119,95 €

suitable controllers and dimmers from page 735
 additional power supplies from page 698

FLOOD FLEX

The FLOOD FLEX series makes the illumination of surfaces and objects in outdoor areas even more flexible. The highlight: The heads of the compact surface-mounted spotlights can be swiveled sideways as needed, allowing for varying lighting angles without having to realign the spotlights as a whole. While the FLOOD FLEX I is equipped with a centrally arranged luminaire head, the FLOOD FLEX II has two heads arranged next to each other that can be swiveled separately.

FLOOD FLEX I

- aluminium diecast
- dimensions L x W x H: 152,1 x 134,2 x 56 mm
- head can be swivelled sideways
- incl. 2 m connection cable with IP44 connector plug

item	colour	colour temperature	light current	price
732014	■ dark grey	ww 3000 K	700 lm	109,95 €



suitable energy distributors/plug-in socket towers on page 449-453
 suitable mounting accessories for outdoor use from page 800



FLOOD FLEX II

- aluminium diecast
- dimensions L x W x H: 200 x 152 x 56 mm
- heads can be individually swivelled sideways
- incl. 2 m connection cable with IP44 connector plug

item	colour	colour temperature	light current	price
732016	■ dark grey	ww 3000 K	1100 lm	129,95 €



suitable energy distributors/plug-in socket towers on page 449-453
 suitable mounting accessories for outdoor use from page 800



FLOOD RF II -10 RGB

- plastic
- dimensions L x W x H: 133 x 57 x 179 mm
- incl. 2 m connection cable with IP44 connector plug
- incl. radio remote control with approx. 20 m range



item	colour	colour temperature	light current	price
732074	■ anthracite	RGB	270 lm	179,95 €

200-240 Volt	10 W	COB	1 LED	115°	↻	+	-	3 CH	IP65/ IP44
--------------	------	-----	-------	------	---	---	---	------	------------

suitable energy distributors/plug-in socket towers on page 449-453
 suitable mounting accessories for outdoor use from page 800



FLOOD RF II -30 RGB + -60 RGB

- plastic
- incl. 2 m connection cable with IP44 connector plug
- incl. radio remote control with approx. 20 m range

item	colour	colour temperature	light current	power	beam angle	dimensions L x W x H	price
732075	■ anthracite	RGB	1060 lm	30 W	150°	178 x 81 x 215 mm	289,90 €
732076	■ anthracite	RGB	2100 lm	60 W	120°	200 x 98 x 253 mm	419,95 €

100-240 Volt	COB	1 LED	↻	+	-	3 CH	IP65/ IP44
--------------	-----	-------	---	---	---	------	------------

suitable energy distributors/plug-in socket towers on page 449-453
 suitable mounting accessories for outdoor use from page 800



■
page 470



■
page 470



■
page 471



■
page 471



wall washer



CAPH

Despite the linear design, the CAPH wallwasher range is a »round thing«. The wallwashers offer a variety of possibilities to accentuate different objects. Be it the rustic stone wall in warm 3000 K or the modern new building in RGBW. The different optics with symmetrical or asymmetrical beam angles help with positioning.

With the 230 Volt versions, no further accessories are needed. Thanks to the 24 V versions, the CAPH wallwashers can be integrated into all control variants on the market – a »round thing«.



WALL WASHER CAPH SYMMETRIC

- aluminium diecast
- dimensions L x W x H: 1000 x 53,36 x 81,07 mm
- incl. 2 m connection cable with IP44 connector plug

item	colour	colour temperature	light current	price
732079	■ dark grey	ww 3000 K	3000 lm	399,95 €



suitable energy distributors/plug-in socket towers on page 449-453
 suitable mounting accessories for outdoor use from page 800

WALL WASHER CAPH SYMMETRIC

- aluminium diecast
- dimensions L x W x H: 1000 x 53,36 x 81,07 mm
- dimmable via optional controller
- incl. 0.5 m connection cable with WEIPU plug
- incl. 0.5 m connection cable with WEIPU plug



item	colour	colour temperature	light current	price
732071	■ dark grey	RGB WW 3000 K	2800 lm	399,95 €

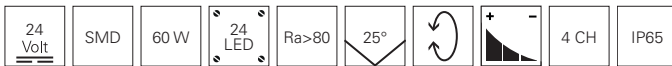

accessories

862164	power supply 24V DC 75,0 W IP20	82,95 €
872085	power supply 24V DC 75,0 W IP67	99,95 €
843059	RF Color+White Controller Set dimmable 12/24/48V DC	119,95 €

suitable Weipu cables/connectors on page 791-793
 additional controller and dimmer from page 735
 additional power supplies from page 698

WALL WASHER CAPH ASYMMETRIC

- aluminium diecast
- dimensions L x W x H: 1000 x 53,36 x 81,07 mm
- incl. 2 m connection cable with IP44 connector plug



item	colour	colour temperature	light current	price
732080	■ dark grey	■ 3000 K	2580 lm	399,95 €

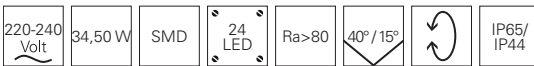

suitable energy distributors/plug-in socket towers on page 449-453
 suitable mounting accessories for outdoor use from page 800

WALL WASHER CAPH ASYMMETRIC

- aluminium diecast
- dimensions L x W x H: 1000 x 53,36 x 81,07 mm
- dimmable via optional controller
- incl. 0.5 m connection cable with WEIPU plug
- incl. 0.5 m connection cable with WEIPU plug



item	colour	colour temperature	light current	price
732072	■ dark grey	■ 3000 K	2480 lm	399,95 €

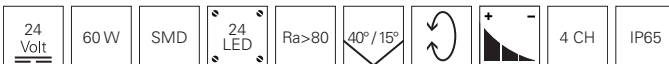

accessories

862164	power supply 24V DC 75,0 W IP20	82,95 €
872085	power supply 24V DC 75,0 W IP67	99,95 €
843059	RF Color+White Controller Set dimmable 12/24/48V DC	119,95 €

suitable Weipu cables/connectors on page 791-793
 additional controller and dimmer from page 735
 additional power supplies from page 698



■ □
page 476



■ □
page 476



■ □
page 477



□ □
page 478



□ □
page 478



□ □
page 480



■ □
page 481



□ □
page 481



□ □
page 482

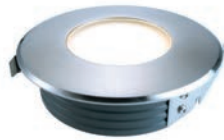

□ □
page 483



□ □
page 483



□ □
page 484



□ □
page 484



□ □
page 485



□ □
page 485



□ □
page 486



□ □
page 487



□ □
page 488



□ □
page 488



□ □
page 490



□ □
page 490



□ □
page 491



□ □
page 491



□ page 492



□ page 492



□ page 493



□ page 494



□ page 494



□ page 495



□ page 495



■ page 496



■ page 496



■ page 497

ground recessed lights



□ □
page 498



□ □
page 499



□ □
page 499



□
page 500



□
page 500



□ □
page 501



ATON, PHAKT UND PAVO

Simple and good – with their robust construction, the ATON, PHAKT and PAVO series provide elegant recessed floor lighting at a low price. The interchangeable light sources allow an individual lighting solution with vision.



ATON

- stainless steel, aluminium diecast
- dimmable via optional illuminants

item	colour		dimensions H x Ø / L x W	price
730474	silver coloured	round	111 x 97 mm	49,95 €
730475	silver coloured	square	111 x 97 x 97 mm	54,95 €



suitable illuminants on page 767

suitable mounting accessories for outdoor use from page 800



PHAKT

- stainless steel
- dimmable via optional illuminants

item	colour		dimensions H x Ø / L x W	price
730476	silver coloured	round	156 x 136 mm	61,95 €
730477	silver coloured	square	156 x 136 x 136 mm	64,95 €



suitable illuminants on page 770-771

suitable mounting accessories for outdoor use from page 800



PAVO

- stainless steel, aluminium diecast
- swivelling insert
- dimmable via optional illuminants

item	colour		dimensions H x Ø / L x W	price
730478	silver coloured	round	156 x 139 mm	96,95 €
730479	silver coloured	square	156 x 139 x 139 mm	109,95 €

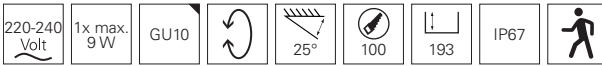

suitable illuminants on page 767

suitable mounting accessories for outdoor use from page 800





BASIC IWW

- stainless steel / aluminium diecast
- dimmable via optional controller
- incl. 0.5 m connection cable with WEIPU plug

item	colour	colour temperature	light current	dimensions H x Ø / L x W	price
730339	silver coloured	3000 K	15 lm round	65 x 45 mm	69,95 €
730340	silver coloured	3000 K	14 lm square	65 x 45 x 45 mm	69,95 €

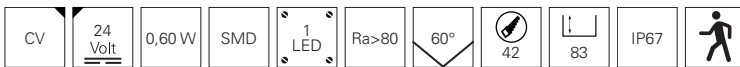

accessories

862230	power supply 24V DC 12,0 W IP65	24,95 €
872083	power supply 24V 40,0 W IP67	79,95 €
843056	RF Single Controller Set dimmable 12/24/48V DC	104,95 €

suitable Weipu cables/connectors on page 791-793
 additional controller and dimmer from page 735
 additional power supplies from page 698

ALZIRR II

- stainless steel / aluminium diecast
- dimensions H x Ø: 82,50 x 55 mm
- dimmable via optional controller
- incl. 1 m connection cable with WEIPU plug



item	colour	colour temperature	light current	price
730470	silver coloured	3000 K	150 lm	89,95 €

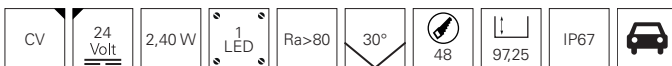

accessories

862230	power supply 24V DC 12,0 W IP65	24,95 €
872083	power supply 24V 40,0 W IP67	79,95 €
843056	RF Single Controller Set dimmable 12/24/48V DC	104,95 €

suitable Weipu cables/connectors on page 791-793
 additional controller and dimmer from page 735
 additional power supplies from page 698



FORNAC

- stainless steel / aluminium diecast
- dimensions H x Ø: 80 x 55 mm
- asymmetric
- dimmable via optional controller
- incl. 1 m connection cable with WEIPU plug [male]



item	colour	colour temperature	light current	price
730447	 silver coloured	 3000 K	110 lm	119,95 €

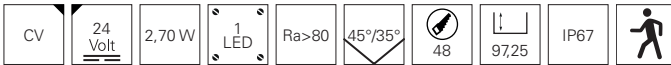

accessories

862230	power supply 24V DC 12,0 W IP65	24,95 €
872083	power supply 24V 40,0 W IP67	79,95 €
843056	RF Single Controller Set dimmable 12/24/48V DC	104,95 €

suitable Weipu cables/connectors on page 791-793
 additional controller and dimmer from page 735
 additional power supplies from page 698



With the kind support of Licht von Klein / www.licht-von-klein.de



NC COB I

- aluminium diecast
- incl. 0,5 m connection cable with protected junction box

item	colour	colour temperature	light current	dimensions H x Ø / L x W	price
730439	■ black	☀ 3000 K	520 lm round	90 x 63 mm	179,95 €
730438	■ black	☀ 3000 K	520 lm square	90 x 63 x 63 mm	179,95 €

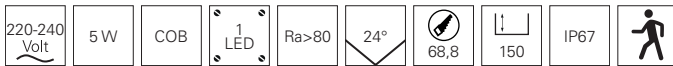

suitable mounting accessories for outdoor use from page 800



EASY COB III WW

- stainless steel / aluminium diecast
- dimensions H x Ø: 96 x 70 mm
- dimmable via optional controller
- incl. 1 m connection cable with WEIPU plug

item	colour	colour temperature	light current	dimensions H x Ø / L x W	price
730469	□ silver coloured	☀ 3000 K	330 lm round	96 x 70 mm	149,95 €
730468	□ silver coloured	☀ 3000 K	330 lm square	96 x 70 x 70 mm	149,95 €

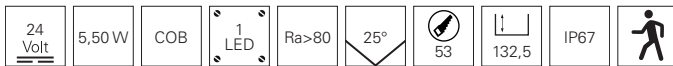

accessories

862230	power supply 24V DC 12,0 W IP65	24,95 €
872083	power supply 24V 40,0 W IP67	79,95 €
843056	RF Single Controller Set dimmable 12/24/48V DC	104,95 €

suitable Weipu cables/connectors on page 791-793
 additional controller and dimmer from page 735
 additional power supplies from page 698

PEACOCK

- stainless steel / aluminium diecast
- dimensions H x Ø: 43 x 58 mm
- incl. 0,5 m connection cable with protected junction box



item	colour	colour temperature	light current	price
730459	 silver coloured	 3000 K	150 lm	109,95 €

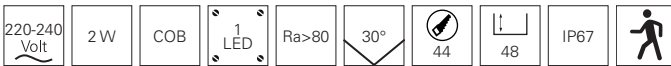

suitable mounting accessories for outdoor use from page 800



With the kind support of Alpbatherme Waldbronn / Ziegler Technics

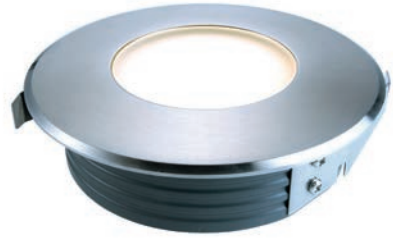

FLAT III WW

- stainless steel / aluminium diecast
- dimensions H x Ø: 42 x 116 mm
- incl. 0,5 m connection cable

item	colour	colour temperature	light current	price
730336	silver coloured	3000 K	25 lm	149,95 €

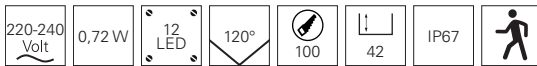

suitable mounting accessories for outdoor use from page 800



FLAT II

- stainless steel / aluminium diecast
- dimensions H x Ø: 42 x 116 mm
- incl. 0,5 m connection cable

item	colour	colour temperature	light current	price
100111	silver coloured	3000 K	400 lm	189,95 €
100112	silver coloured	6000 K	450 lm	189,95 €



suitable mounting accessories for outdoor use from page 800



FLAT I WW

- stainless steel / aluminium diecast
- dimensions H x Ø: 38 x 173 mm
- incl. 0,5 m connection cable

item	colour	colour temperature	light current	price
100114	silver coloured	ww 3000 K	860 lm	249,95 €



suitable mounting accessories for outdoor use from page 800



FLAT I RGB

- stainless steel / aluminium diecast
- dimensions H x Ø: 38 x 173 mm
- dimmable via optional controller
- incl. 0.5 m connection cable with WEIPU plug

item	colour	colour temperature	light current	price
100116	silver coloured	RGB	510 lm	289,95 €

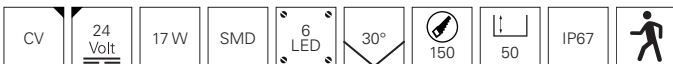

accessories

872083	power supply 24V 40,0 W IP67	79,95 €
843058	RF RGB Controller Set dimmable 12/24/48V DC	114,95 €

suitable Weipu cables/connectors on page 791-793
 additional controller and dimmer from page 735
 additional power supplies from page 698



GROUND RECESSED LIGHT II WW

- stainless steel / aluminium diecast
- dimensions H x Ø: 102 x 116 mm
- incl. 0,5 m connection cable

item	colour	colour temperature	light current	price
730255	silver coloured	3000 K	280 lm	169,95 €



suitable mounting accessories for outdoor use from page 800



GROUND RECESSED LIGHT I WW

- stainless steel / aluminium diecast
- dimensions H x Ø: 102 x 116 mm
- dimmable via optional controller
- incl. 1 m connection cable with WEIPU plug

item	colour	colour temperature	light current	price
100133	silver coloured	3000 K	720 lm	169,95 €

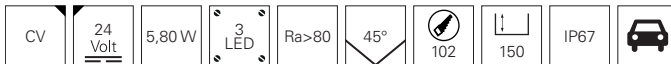

accessories

862230	power supply 24V DC 12,0 W IP65	24,95 €
872083	power supply 24V 40,0 W IP67	79,95 €
843056	RF Single Controller Set dimmable 12/24/48V DC	104,95 €

suitable Weipu cables/connectors on page 791-793
 additional controller and dimmer from page 735
 additional power supplies from page 698



TALL COB I WW

- stainless steel / aluminium diecast
- dimensions H x Ø: 102 x 116 mm
- incl. 0,5 m connection cable

item	colour	colour temperature	light current	price
730211	 silver coloured	 3000 K	720 lm	179,95 €

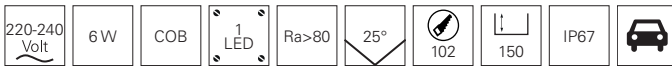

suitable mounting accessories for outdoor use from page 800







With the kind support of Licht von Klein / www.licht-von-klein.de



HP IWW + II WW

- stainless steel / aluminium diecast
- dimensions H x Ø: 111 x 173 mm
- incl. 0,5 m connection cable

item	colour	colour temperature	light current	power	price
730249	 silver coloured	 3000 K	540 lm	6 W walkable	219,95 €
730250	 silver coloured	 3000 K	920 lm	10 W passable	239,95 €



suitable mounting accessories for outdoor use from page 800





GROUND RECESSED LIGHT

- stainless steel / aluminium diecast
- dimensions H x Ø: 111 x 173 mm
- asymmetric
- incl. 0,5 m connection cable

item	colour	colour temperature	light current	price
730289	 silver coloured	 3000 K	700 lm	249,95 €



suitable mounting accessories for outdoor use from page 800



HP IV WW

- stainless steel / aluminium diecast
- dimensions H x Ø: 111 x 173 mm
- asymmetric
- dimmable via optional controller
- incl. 0.5 m connection cable with WEIPU plug

item	colour	colour temperature	light current	price
730296	 silver coloured	 3000 K	800 lm	249,95 €



accessories

872083 power supply | 24V | 40,0 W | IP67 **79,95 €**

843056 RF Single Controller Set dimmable | 12/24/48V DC **104,95 €**

suitable Weipu cables/connectors on page 791-793

additional controller and dimmer from page 735



additional power supplies from page 698





COB 12 SOFT WW

- stainless steel / aluminium diecast
- dimensions L x Ø: 128 x 173 mm
- incl. 0,5 m connection cable
- incl. honeycomb filter

item	colour	colour temperature	light current	price
730420	 silver coloured brushed	 3000 K	900 lm	419,95 €

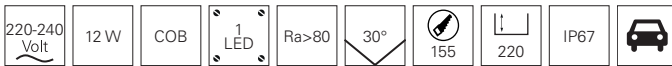



suitable mounting accessories for outdoor use from page 800



COB 25 SOFT WW

- stainless steel / aluminium diecast
- dimensions L x Ø: 190 x 250 mm
- incl. 0,5 m connection cable
- incl. honeycomb filter

item	colour	colour temperature	light current	price
730421	 silver coloured brushed	 3000 K	1650 lm	579,95 €

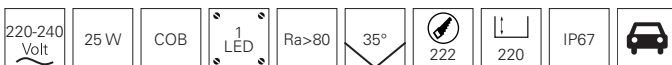

suitable mounting accessories for outdoor use from page 800



SOFT FLEX 7

- stainless steel / aluminium diecast
- dimensions H x Ø: 128 x 173 mm
- radiation direction adjustable
- incl. 1 m connection cable
- incl. honeycomb filter

item	colour	colour temperature	light current	price
730267	silver coloured	3000 K	480 lm	349,95 €



suitable mounting accessories for outdoor use from page 800



SOFT FLEX 18

- stainless steel / aluminium diecast
- dimensions L x Ø: 190 x 250 mm
- incl. 1 m connection cable
- incl. honeycomb filter

item	colour	colour temperature	light current	price
730266	silver coloured	3000 K	770 lm	599,95 €



suitable mounting accessories for outdoor use from page 800



SQUARE COB I WW

- stainless steel / aluminium diecast
- dimensions L x W x H: 125 x 125 x 75 mm
- incl. 0,5 m connection cable

item	colour	colour temperature	light current	price
730209	silver coloured	3000 K	700 lm	169,95 €

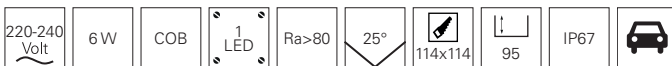

suitable mounting accessories for outdoor use from page 800



SQUARE II WW

- stainless steel / aluminium diecast
- dimensions L x W x H: 125 x 125 x 75 mm
- incl. 0,5 m connection cable
- incl. 2 glass panes [Prisma, white]

item	colour	colour temperature	light current	price
730248	silver coloured	3000 K	160 lm	179,95 €

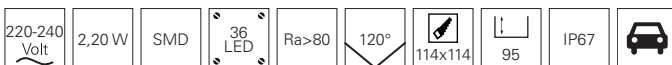

suitable mounting accessories for outdoor use from page 800



SQUARE I WWA

- stainless steel / aluminium diecast
- asymmetric
- dimensions L x W x H: 160 x 160 x 79 mm
- incl. 0,5 m connection cable

item	colour	colour temperature	light current	price
730199	 silver coloured	 3000 K	400 lm	249,95 €

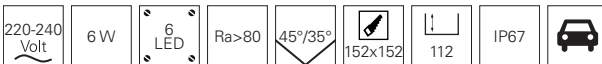

suitable mounting accessories for outdoor use from page 800





EASY SQUARE II RGB

- stainless steel / aluminium diecast
- dimensions L x W x H: 55 x 55 x 99 mm
- dimmable via optional controller
- incl. 0.5 m connection cable with WEIPU plug

item	colour	colour temperature	light current	price
730244	silver coloured		80 lm	179,95 €



accessories

872083 power supply | 24V | 40,0 W | IP67 **79,95 €**

843058 RF RGB Controller Set dimmable | 12/24/48V DC **114,95 €**

suitable Weipu cables/connectors on page 791-793
 additional controller and dimmer from page 735
 additional power supplies from page 698



GROUND RECESSED LIGHT III RGB

- stainless steel / aluminium diecast
- dimensions H x Ø: 102 x 116 mm
- dimmable via optional controller
- incl. 0.5 m connection cable with WEIPU plug

item	colour	colour temperature	light current	price
730276	silver coloured		280 lm	179,95 €



accessories

872083 power supply | 24V | 40,0 W | IP67 **79,95 €**

843058 RF RGB Controller Set dimmable | 12/24/48V DC **114,95 €**

suitable Weipu cables/connectors on page 791-793
 additional controller and dimmer from page 735
 additional power supplies from page 698



HOROLOGII

- stainless steel / aluminium diecast
- dimensions H x Ø: 79 x 116 mm
- dimmable via optional controller
- incl. 0.5 m connection cable with WEIPU plug [male]

item	colour	colour temperature	light current	price
730449	<input type="checkbox"/> silver coloured	5700-7000 K	257 lm	199,95 €



accessories

872083	power supply 24V 40,0 W IP67	79,95 €
843059	RF RGB+White Controller Set dimmable 12/24/48V DC	119,95 €

suitable Weipu cables/connectors on page 791-793
 additional controller and dimmer from page 735
 additional power supplies from page 698



CANUM

- stainless steel / aluminium diecast
- dimensions H x Ø: 111 x 173 mm
- dimmable via optional controller
- incl. 0.5 m connection cable with WEIPU plug

item	colour	colour temperature	light current	price
730454	<input type="checkbox"/> silver coloured		510 lm	349,95 €



accessories

872083	power supply 24V 40,0 W IP67	79,95 €
843058	RF RGB Controller Set dimmable 12/24/48V DC	114,95 €

suitable Weipu cables/connectors on page 791-793
 additional controller and dimmer from page 735
 additional power supplies from page 698



HELIOS I

- aluminium diecast
- dimensions H x Ø: 54 x 210 mm
- socket H x Ø: 25 x 165 mm
- incl. 4 heavy duty anchor

item	colour	colour temperature	light current	price
732143	■ anthracite	ww 3000 K	34 lm	119,95 €

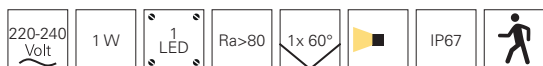

suitable mounting accessories for outdoor use from page 800



HELIOS II

- aluminium diecast
- dimensions H x Ø: 50 x 210 mm
- socket H x Ø: 7 x 198 mm
- incl. 4 heavy duty anchor

item	colour	colour temperature	light current	price
732049	■ anthracite	ww 3000 K	65 lm	119,95 €

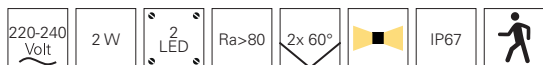

suitable mounting accessories for outdoor use from page 800

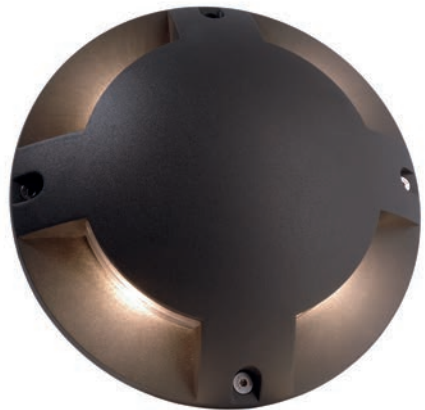

HELIOS IV

- aluminium diecast
- dimensions H x Ø: 50 x 210 mm
- socket H x Ø: 7 x 198 mm
- incl. 4 heavy duty anchor

item	colour	colour temperature	light current	price
732050	 anthracite	 3000 K	150 lm	119,95 €

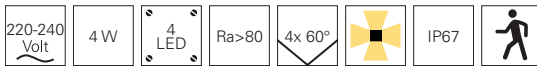

suitable mounting accessories for outdoor use from page 800

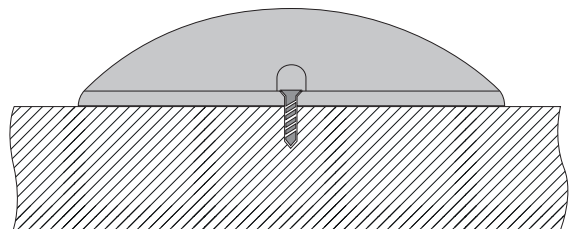
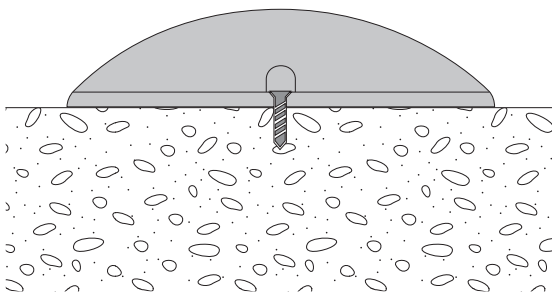



LINE IV 1.9WW + 3.7WW

- stainless steel / aluminium diecast
- incl. 1 m connection cable

item	colour	colour temp.	light current	dimensions L x W x H	cutout L x W	power	light source	price
100108	silver coloured	3000 K	35 lm	195 x 63 x 65 mm	180 x 58 mm	1,90 W	10 LED	159,95 €
100109	silver coloured	3000 K	85 lm	328 x 63 x 65 mm	313 x 58 mm	6,00 W	20 LED	219,95 €



suitable mounting accessories for outdoor use from page 800



With the kind support of Licht von Klein / www.licht-von-klein.de

LINE I WW + II WW

- stainless steel / aluminium diecast
- asymmetric light distribution
- incl. 0,5 m connection cable



item	colour	colour temp.	light current	dimensions L x W x H	cutout L x W	power	light source	price
730292	silver coloured	3000 K	340 lm	195 x 63 x 65 mm	180 x 58 mm	4,50 W	3 LED	179,95 €
730262	silver coloured	3000 K	730 lm	328 x 63 x 65 mm	313 x 58 mm	10,00 W	6 LED	249,95 €

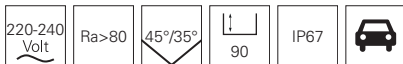

suitable mounting accessories for outdoor use from page 800



LINE V WW + VI WW

- stainless steel / aluminium diecast
- incl. 0,5 m connection cable

item	colour	colour temp.	light current	dimensions L x W x H	cutout L x W	power	light source	price
730434	silver coloured	3000 K	1100 lm	549 x 68 x 31.5 mm	524 x 58 mm	16,00 W	12 LED	369,95 €
730432	silver coloured	3000 K	2300 lm	1025 x 68 x 80 mm	1004 x 58 mm	34,00 W	24 LED	599,95 €













suitable mounting accessories for outdoor use from page 800

LINE II WWA

- stainless steel / aluminium diecast
- dimensions L x W x H: 328 x 63 x 65 mm
- asymmetric light distribution
- dimmable via optional controller
- incl. 0.5 m connection cable with WEIPU plug

item	colour	colour temp.	light current	price
730008	 silver coloured	 3000 K	750 lm	249,95 €

									
--	---	---	---	---	---	---	---	---	---

accessories

872083 power supply | 24V | 40,0 W | IP67 **79,95 €**

843056 RF Single Controller Set dimmable | 12/24/48V DC **104,95 €**









suitable Weipu cables/connectors on page 791-793
 additional controller and dimmer from page 735
 additional power supplies from page 698



LINE III RGB

- stainless steel / aluminium diecast
- dimensions L x W x H: 328 x 63 x 65 mm
- dimmable via optional controller
- incl. 0.5 m connection cable with WEIPU plug

item	colour	colour temp.	light current	price
730263	 silver coloured		400 lm	299,95 €

									
--	---	---	---	---	---	---	---	---	---

accessories

872083 power supply | 24V | 40,0 W | IP67 **79,95 €**

843058 RF RGB Controller Set dimmable | 12/24/48V DC **114,95 €**



suitable Weipu cables/connectors on page 791-793
 additional controller and dimmer from page 735
 additional power supplies from page 698





LINE V RGB + VI RGB

- stainless steel / aluminium diecast
- dimmable via optional controller
- incl. 0.5 m connection cable with WEIPU plug

item	colour	colour temp.	light current	dimensions L x W x H	cutout L x W	power	light source	price
730437	<input type="checkbox"/> silver coloured		340 lm	549 x 68 x 32,5 mm	524 x 58 mm	18,00 W	12 LED	419,95 €
730436	<input type="checkbox"/> silver coloured		700 lm	1025 x 68 x 31,5 mm	1004 x 58 mm	42,80 W	24 LED	679,95 €

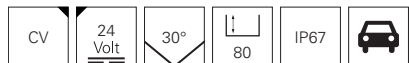

accessories

843058 RF RGB Controller Set dimmable | 12/24/48V DC **114,95 €**

accessories for **730437**

872083 power supply | 24V | 40,0 W | IP67 **79,95 €**

accessories for **730436**

872085 power supply | 24V | 75,0 W | IP67 **99,95 €**

872094 power supply | 24V | 100,0 W | IP67 **119,95 €**

suitable Weipu cables/connectors on page 791-793
 additional controller and dimmer from page 735
 additional power supplies from page 698



page 504

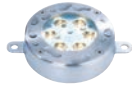

page 505

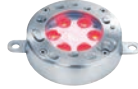

page 505



page 506



page 507



underwater lights



SNAPPER II WW

- stainless steel
- dimensions H x Ø: 73 x 68,5 mm
- dimmable via optional controller
- incl. 10 m connection cable with WEIPU plug IP67



item	colour	colour temperature	light current	price
740007	silver coloured	3000 K	105 lm	159,95 €

--	--	--	--	--	--	--	--	--

accessories

872045 LED safety transformer dimmable | 24V DC | 60,0 W **329,95 €**

843056 RF Single Controller Set dimmable | 12/24/48V DC **104,95 €**

suitable Weipu cables/connectors on page 791-793
 additional controller and dimmer from page 735
 additional power supplies from page 698

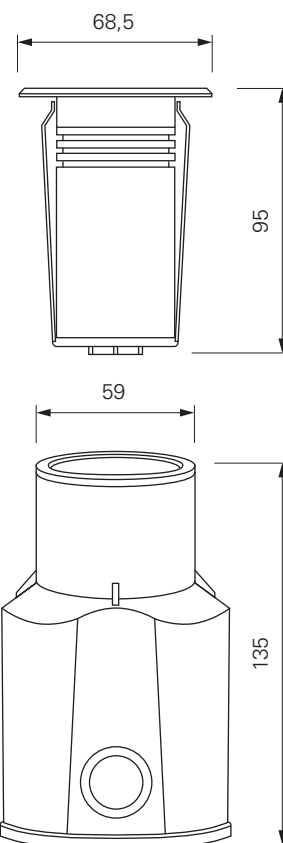

SHARK I WW

- stainless steel
- dimensions H x Ø: 33 x 115 mm
- dimmable via optional controller
- incl. 10 m connection cable with WEIPU plug IP67



item	colour	colour temperature	light current	price
785016	<input type="checkbox"/> silver coloured	3000 K	770 lm	279,95 €

CV	24 Volt	11,80 W	6 LED	Ra>80	30°	IP68
----	---------	---------	-------	-------	-----	------

accessories

872045	LED safety transformer dimmable 24V DC 60,0 W	329,95 €
872046	LED safety transformer dimmable 24V DC 150,0 W	449,95 €
843056	RF Single Controller Set dimmable 12/24/48V DC	104,95 €

suitable Weipu cables/connectors on page 791-793
 additional controller and dimmer from page 735
 additional power supplies from page 698

SHARK I RGB

- stainless steel
- dimensions H x Ø: 33 x 115 mm
- dimmable via optional controller
- incl. 10 m connection cable with WEIPU plug IP67



item	colour	colour temperature	light current	price
785017	<input type="checkbox"/> silver coloured	RGB	400 lm	309,95 €

CV	24 Volt	15 W	6 LED	30°	3 CH	IP68
----	---------	------	-------	-----	------	------

accessories

872045	LED safety transformer dimmable 24V DC 60,00W	329,95 €
872046	LED safety transformer dimmable 24V DC 150,00 W	449,95 €
843058	RF RGB Controller Set dimmable 12/24/48V DC	114,95 €

suitable Weipu cables/connectors on page 791-793
 additional controller and dimmer from page 735
 additional power supplies from page 698

FIARA

- stainless steel
- dimensions L x W x H x Ø: 95 x 106 x 150 x 95 mm
- socket L x W x H: 65 x 40 x 60 mm
- dimmable via optional controller
- incl. 10 m connection cable with WEIPU plug IP67



item	colour	colour temperature	light current	price
740005	silver coloured	3000 K	670 lm	349,95 €



accessories

872045	LED safety transformer dimmable 24V DC 60,0 W	329,95 €
872046	LED safety transformer dimmable 24V DC 150,0 W	449,95 €
843056	RF Single Controller Set dimmable 12/24/48V DC	104,95 €

suitable Weipu cables/connectors on page 791-793
 additional controller and dimmer from page 735
 additional power supplies from page 698

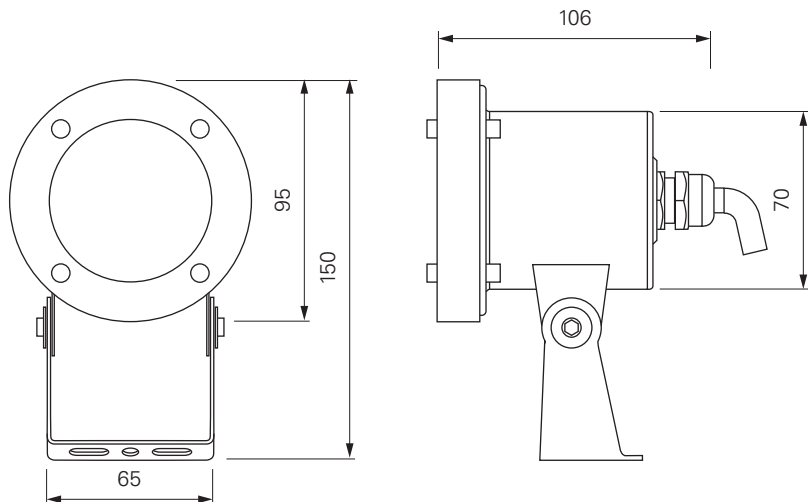

FIARA

- stainless steel
- dimensions L x W x H x Ø: 127 x 120 x 195 x 127 mm
- socket L x W x H: 93 x 50 x 80 mm
- dimmable via optional controller
- incl. 10 m connection cable with WEIPU plug IP67



item	colour	colour temperature	light current	price
740006	silver coloured	3000 K	1200 lm	389,95 €

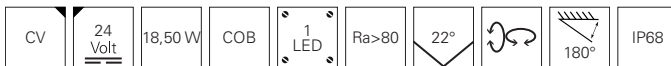

accessories

872045	LED safety transformer dimmable 24V DC 60,0 W	329,95 €
872046	LED safety transformer dimmable 24V DC 150,0 W	449,95 €
843056	RF Single Controller Set dimmable 12/24/48V DC	104,95 €

suitable Weipu cables/connectors on page 791-793
 additional controller and dimmer from page 735
 additional power supplies from page 698

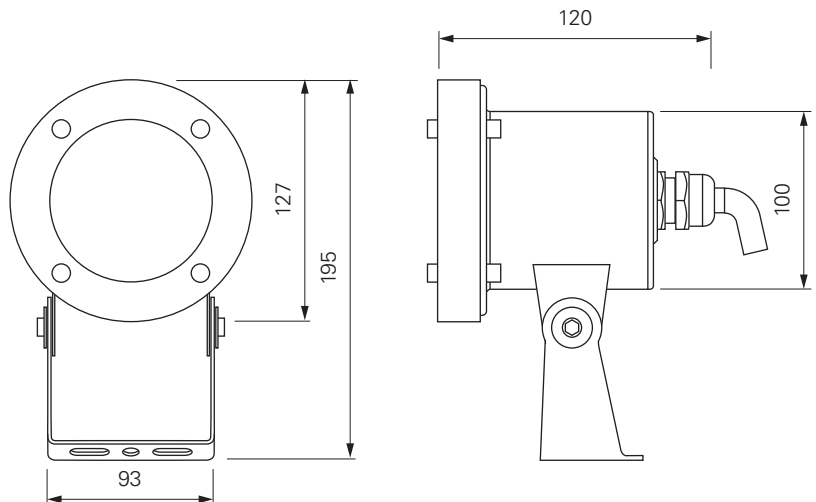



□ ■ □
page 510



■ □
page 511



■ □
page 512



■ □
page 514



floodlight





FLOOD SMD 15 + 30 + 50

- aluminium diecast, glass
- incl. 1,2 m connection cable mit IP44 plug

suitable
power
luminaires
page 321
707130
707138-707033

item	colour	colour temp.	light current	dimensions L x W x H	socket L x W	power	light source	price
732147	silver	3000 K	1800 lm	170 x 144 x 27 mm	179 x 20 mm	15 W	36 LED	89,95 €
732149	silver	4000 K	1950 lm	170 x 144 x 27 mm	179 x 20 mm	15 W	36 LED	89,95 €
732148	black	3000 K	1325 lm	170 x 144 x 27 mm	179 x 20 mm	15 W	36 LED	89,95 €
732150	silver	3000 K	3600 lm	230 x 192,5 x 40,5 mm	237 x 25 mm	30 W	72 LED	129,95 €
732152	silver	4000 K	3900 lm	230 x 192,5 x 40,5 mm	237 x 25 mm	30 W	72 LED	129,95 €
732151	black	3000 K	3600 lm	230 x 192,5 x 40,5 mm	237 x 25 mm	30 W	72 LED	129,95 €
732153	silver	3000 K	4130 lm	290 x 244 x 40,5 mm	302 x 30 mm	50 W	108 LED	179,95 €
732155	silver	4000 K	4190 lm	290 x 244 x 40,5 mm	302 x 30 mm	50 W	108 LED	179,95 €
732154	black	3000 K	4130 lm	290 x 244 x 40,5 mm	302 x 30 mm	50 W	108 LED	179,95 €



suitable mounting accessories for outdoor use from page 800
suitable energy distributors/plug-in socket towers on page 449-453



FLOOD COB 30/50/80 AMBER

- aluminium diecast / plastic
- incl. 1m connection cable with IP44 connector plug

item	colour	colour temperature	light current	dimensions L x W x H	power	price
730464	■ anthracite	A 1700 K	710 lm	178 x 81 x 215 mm	30 W	229,95 €
730465	■ anthracite	A 1700 K	1255 lm	200 x 98 x 253 mm	50 W	339,95 €
730466	■ anthracite	A 1700 K	1285 lm	291 x 250 x 116 mm	80 W	449,95 €



suitable mounting accessories for outdoor use from page 800
 suitable energy distributors/plug-in socket towers on page 449-453

accessories for 730464

930659 wall bracket / display arm | black **52,95 €**

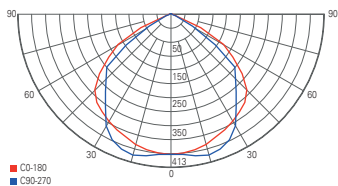

light distribution curve

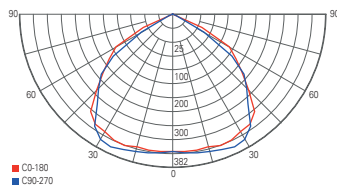

light distribution curve

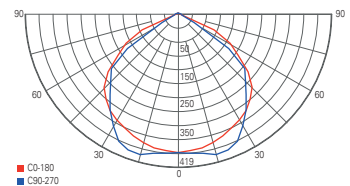

light distribution curve



BRACHIUM

- aluminium diecast
- dimensions L x W x H: 316 x 286 x 41 mm
- socket L x W x H: 327 x 28 x 160 mm
- incl. 2 m connection cable with IP44 connector plug

item	colour	colour temperature	light current	price
732064	■ black	☀ 3000 K	8100 lm	259,95 €
732105	■ black	☀ 4000 K	8400 lm	259,95 €

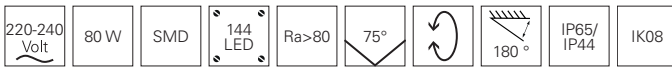

suitable mounting accessories for outdoor use from page 800
 suitable energy distributors/plug-in socket towers on page 449-453

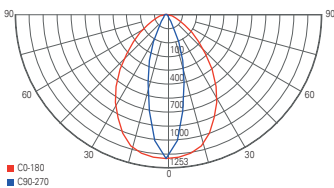
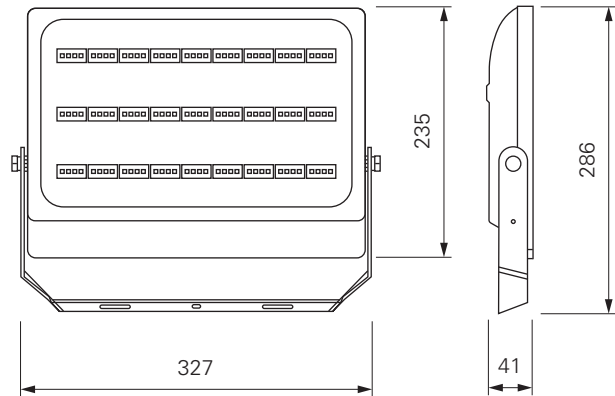

light distribution curve 732064

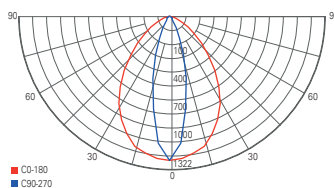

light distribution curve 732105



ATIK

The surface-mounted luminaires of the ATIK series are real power packs and deliver up to 40,000 lumens of light current in the light colours warm white, neutral white and cool white. Thanks to their especially flat construction, the ATIK spotlights can be installed in almost any location. The floodlights become even more flexible with the separately available anti-dazzle device and the optional protective front grid.



ATIK

- aluminium diecast
- dimensions L x W x H: 319 x 90 x 411 mm
- incl. 2 m connection cable with IP44 connector plug

item	colour	colour temperature	light current	power	light source	price
732041	■ black	■ WW 3000 K	17500 lm	150 W	418 LED	399,95 €
732096	■ black	■ NW 4000 K	21350 lm	150 W	418 LED	399,95 €
732099	■ black	■ CW 5000 K	20500 lm	150 W	418 LED	399,95 €
732043	■ black	■ WW 3000 K	24200 lm	200 W	320 LED	519,95 €
732097	■ black	■ NW 4000 K	28450 lm	200 W	320 LED	519,95 €
732100	■ black	■ CW 5000 K	27400 lm	200 W	320 LED	499,95 €
732045	■ black	■ WW 3000 K	26900 lm	240 W	320 LED	579,95 €
732098	■ black	■ NW 4000 K	31800 lm	240 W	320 LED	579,95 €
732101	■ black	■ CW 5000 K	31050 lm	240 W	320 LED	579,95 €
732102	■ black	■ NW 4000 K	39900 lm	300 W	416 LED	679,95 €
732103	■ black	■ CW 5000 K	39900 lm	300 W	416 LED	679,95 €



accessories

- 930410** anti-dazzle device | black | 122 mm **29,95 €**
- 930411** protective grid metal | black | 57 mm **17,95 €**

suitable mounting accessories for outdoor use from page 800
 suitable energy distributors/plug-in socket towers on page 449-453



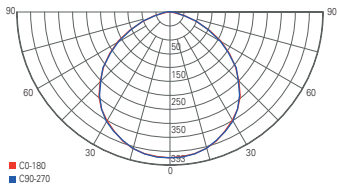
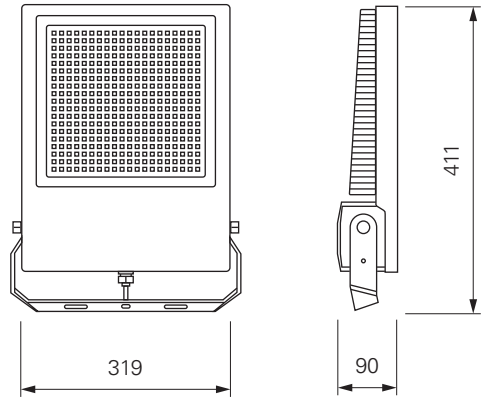

light distribution curve 732041

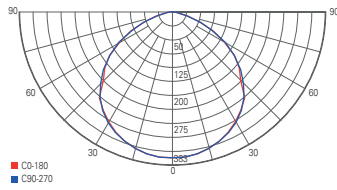

light distribution curve 732096

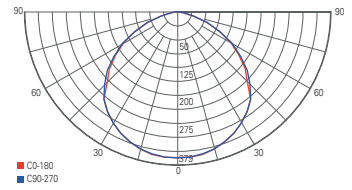

light distribution curve 732099

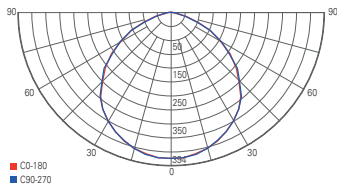

light distribution curve 732043

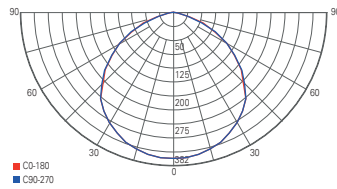

light distribution curve 732097

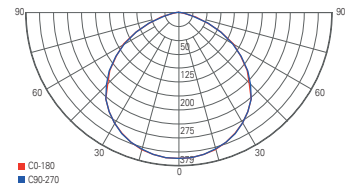

light distribution curve 732100

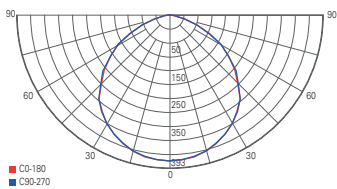

light distribution curve 732045

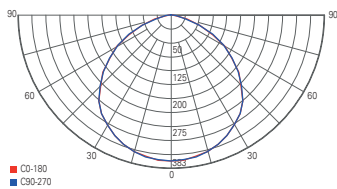

light distribution curve 732098

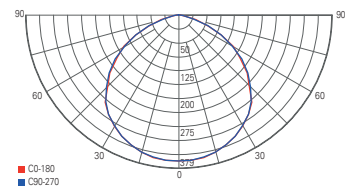

light distribution curve 732101

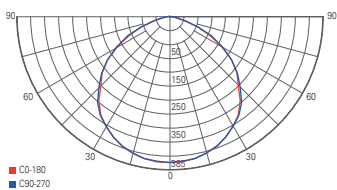

light distribution curve 732102

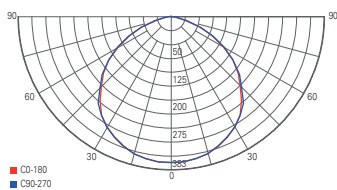

light distribution curve 732103



□ ■
page 518



■ □
page 519



■
page 519



display lights





ATIS II

- aluminium diecast
- dimensions L x W: 526 x 144 mm
- socket H x Ø: 40 x 95 mm
- dimmable via phase control or phase cut-off
- rotating and swivelling luminaire head

item	colour	colour temperature	light current	price
688020	white	3000 K	1120 lm	219,95 €
688021	anthracite	3000 K	1120 lm	219,95 €

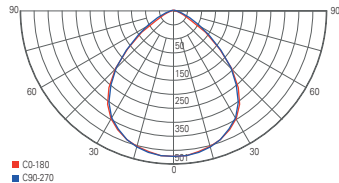

light distribution curve 688020

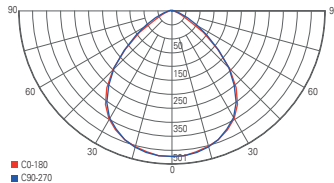

light distribution curve 688021





KEID

- aluminium diecast
- dimensions L x H x Ø: 120 x 580 x 75 mm
- socket H x Ø: 37 x 99 mm
- rotating and swivelling luminaire head

item	colour	colour temperature	light current	power	price
688019	■ dark grey	www 3000 K	800 lm	10 W	169,95 €
688024	■ dark grey	www 3000 K	1350 lm	20 W	179,95 €

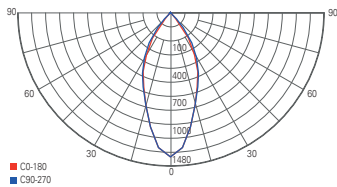

light distribution curve 688019

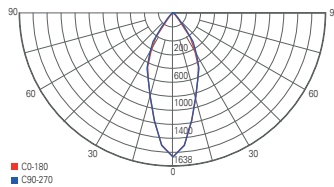

light distribution curve 688024

MOBBY II

- aluminium diecast
- dimensions L x H x Ø: 680 x 100 x 84 mm
- socket H x Ø: 34 x 95 mm
- dimmable via phase control or phase cut-off
- rotating and swivelling luminaire head



item	colour	colour temperature	light current	price
688008	■ anthracite	www 3000 K	810 lm	199,95 €

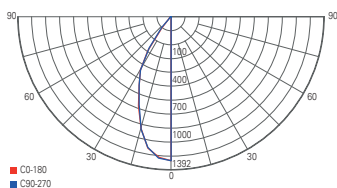
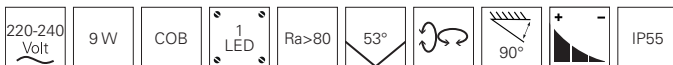

light distribution curve



ALUMINIUM PROFILES

- 522 linear light in 5 steps
- 524 aluminium profiles | overview
- 527 assembly for profiles and stripes
- 528 homogeneous light image
- 532 U-profiles | flat + high | built-in/built-on
- 544 T-profiles | flat + high | built-in
- 556 H- und groove-profiles
- 566 step/plinth/angle/corner-profiles | built-in/built-on
- 592 dry construction profiles
- 602 tile profiles
- 618 profiles for outdoor use | walkable/trafficable

LINEAR LIGHT IN 5 STEPS

STEP BY STEP TO BECOMING A LINEAR LIGHT PROFESSIONAL!

It has never been quicker and easier to put together an individually and perfectly coordinated linear light in max. 5 steps. Test how quickly and easily you can put your personal project into practice.

1

CHOOSE YOUR PROFILE

Whether for indoor or outdoor use, for wide or narrow LED stripes, whether the profile is to be should be low or high. Matching to this you can choose between different shapes and light transmittance of the covers.

2

CHOOSE THE RIGHT LED STRIPE

You can choose between strips for indoor or outdoor use, with one or more light colours, high-power strips for basic lighting or fewer lumens for ambient lighting. Various cut sizes and LED spacing also perfectly round off our range here.



3

SELECT THE REQUIRED POWER SUPPLY

In addition to the various protection classes for the respective place of use and voltages, you can choose from different designs and power classes. Our range is complemented by power supplies that can be dimmed directly or controlled via Dali, KNX or 1-10V.

4

DO YOU NEED A CONTROLLER TO STEER?

In this category, you can select the appropriate control controller or LED dimmer according to requirements and customer wishes. Whether control via radio, smartphone, DMX, Dali, etc. – almost no [control] wishes remain unfulfilled!



5

ACCESSORIES, MOUNTING MATERIAL & CO

In the last step, you will find everything that makes installation easier, faster and more comfortable and gives the linear light a perfect finish.





U-profiles
flat
from page 532



U-profiles
high
from page 532



T-profiles
flat
from page 544



T-profiles
high
from page 544

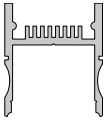

H-Profile
high
page 556



groove-profile
U-profile
page 558

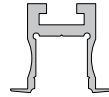

groove-profile
T-profile
page 560



groove-profile
U-profile
page 562

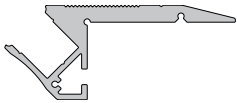

step-profile
built-on
page 566

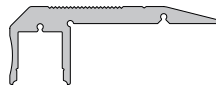

step-profile
built-on
page 568

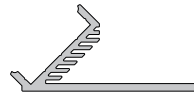

angle-profile
angle 45°
page 570

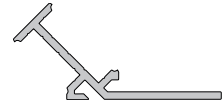

angle-profile
angle 135°
page 572



built-on-Profile
built-on | substructure
page 576

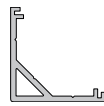

corner-profile
built-on
page 578



corner-profile
built-on
from page 580



socket-profile
built-on
page 574



corner-profile
built-on | built-in
page 582



corner-profiles
built-on
from page 584

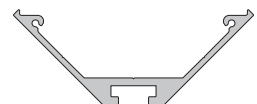

corner-profile
built-on
page 588

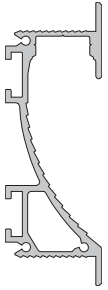

dry construction profile
wall cove
page 592

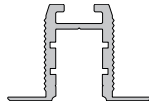

dry construction profile
wall, ceiling
page 594

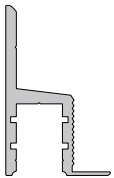

dry construction profile
ceiling cove
page 596

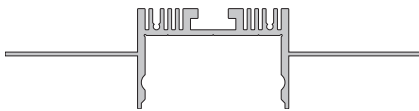

dry construction profile
wall, ceiling
page 598

aluminium profiles



tile profiles
built-in | closing
from page 602

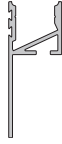

tile profile
closing
page 606

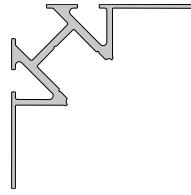

tile profiles
inside corner
from page 608

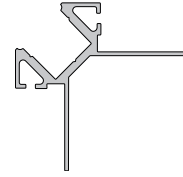

tile profiles
outside corner
from page 612



profile for outdoor
built-in | built-on
page 618



profile for outdoor
built-in
page 620

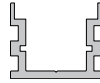

profile for outdoor
built-in | built-on
page 622

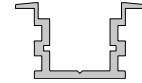

profile for outdoor
built-in
page 624

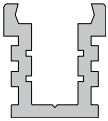

profiles for outdoor
built-in | passable
page 626



ASSEMBLY FOR PROFILES & STRIPES

We provide our products individually made to measure on request.
You will receive the prices on request.



989100 – service package I – profile cut

profile is shortened to desired length, tolerance ± 1 mm | sawing loss 4 mm

989105 – drill hole end cap / profile

hole for cable outlet in end cap or profile



989200 – service package II – cover cut

cover is shortened to desired length, tolerance ± 1 mm | sawing loss 4 mm



989300 – service package III – stripe cut

LED stripe is adapted to desired length, taking into account segment and maximum total length, including soldering of a cable lead of the desired length and open, tinned wire ends

989305 – cable – connecting cable / cores 1 channel

989310 – cable – connecting cable / cores 2 channel

989315 – cable – connecting cable / cores 3 + 4 channel

989320 – cable – mini cable / cores 1 - 4 channel

989325 – cable – connecting cable / cores 5 channel

989301 – 2nd connecting cable

attachment of a 2nd connecting cable / cores for further connection with open tinned wire ends

989302 – connecting cable

attaching / soldering a fixed connection line / cores between 2 stripe pieces

[max. 1m connection line / cores incl., a longer connection will be charged by the metre]

original length and max. total length of the strip to be operated may not be exceeded by sections be exceeded

989350 – IP surcharge – sealing stripe

sealing a shortened IP stripe / gluing an end cap



989400 – service package IV – complete assembly

bringing together and assembling all components into a finished luminaire
incl. function test and cable flag

[for desired length, please add 2cm to the cut length of the LED stripe segment
for connection space, length tolerance ± 2 mm]



HOMOGENEOUS LIGHT IMAGE

How to achieve a homogeneous light image

In combination with a milky 40% cover and a matching LED stripe, a homogeneous light image can be created. The distance [pixel pitch] between the LEDs and the cover is decisive.

The rule of thumb here is:

The distance between the LEDs should be smaller than the distance between the LEDs and the cover.

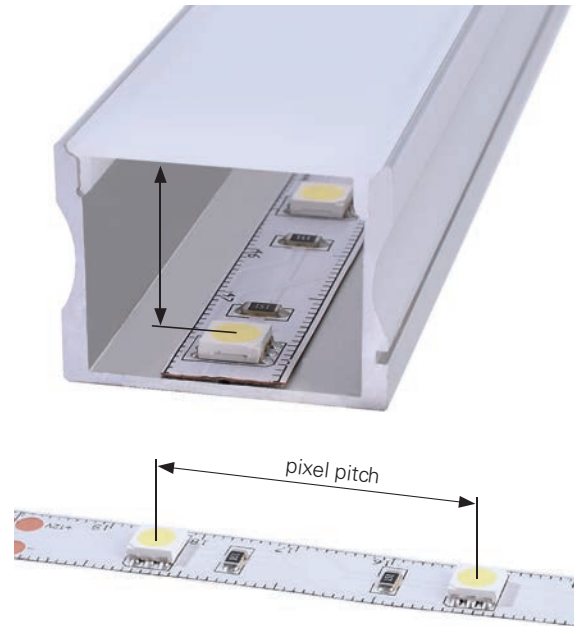

PROFILE DESCRIPTION

mounting type: A = built-on
E = built-in

Width of the series [10 profile] / of the matching LED stripe

AU - 01 - 10

basic form

series

TRANSLUCENCY / LIGHT TRANSMISSION

95% clear

75% mat

40% milky

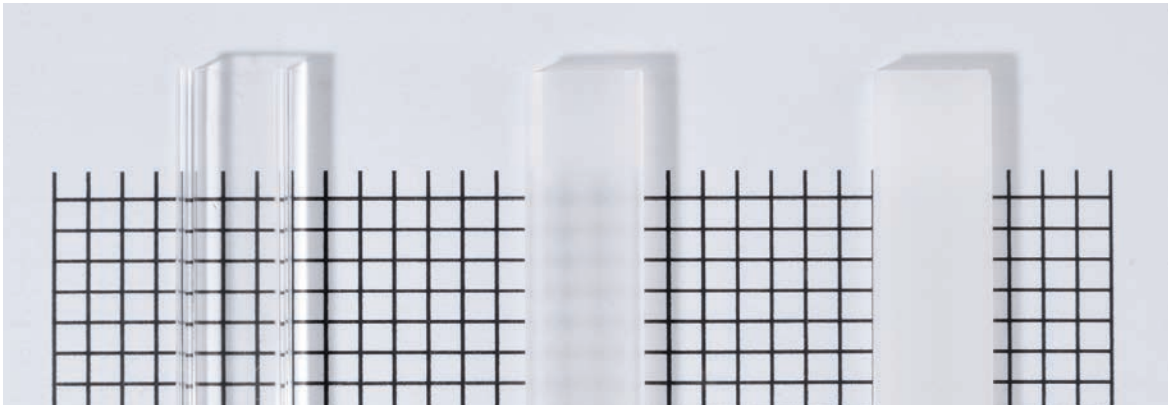
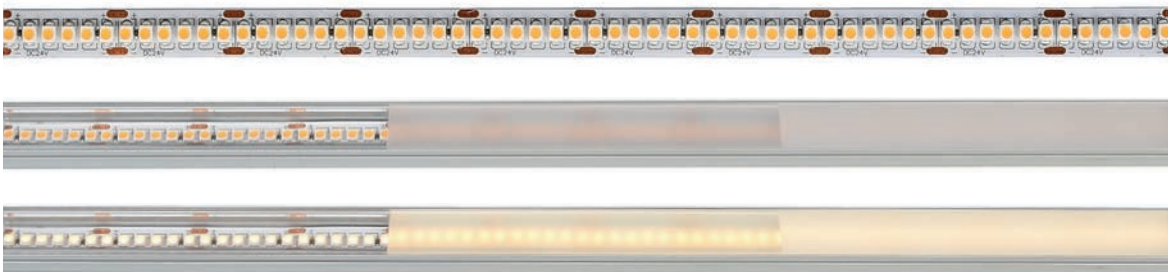

Illustration of various LED stripes with different pixel pitches in combination with three different light transmittances in the covers. This small selection clearly illustrates the optical differences of some LED stripes in combination with different covers.

120 LED/m
cutting option 50 mm / 6 LED



240 LED/m
cutting option 25 mm / 6 LED



700LED/m
cutting option 10 mm / 7 LED

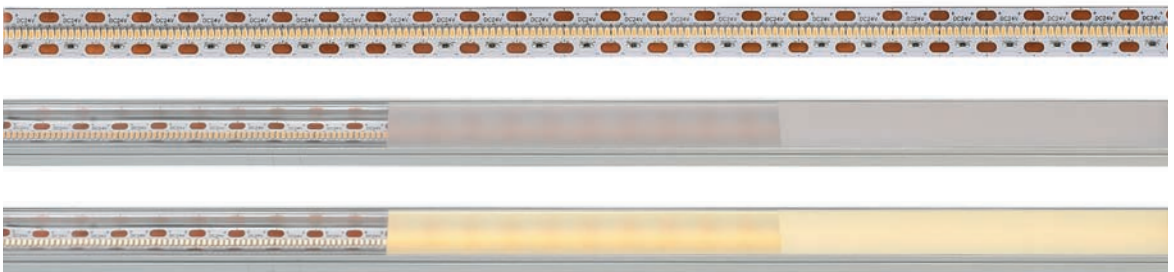

COB 480 LED/m
cutting option 50 mm / 24 LED





With the kind support of BEST Bellemann Elektro Service Team GmbH, Rauenberg-Malschenberg



U- and T-profiles

The profiles of these series are available in various designs. Thanks to their universal profile shape, they can be used flexibly in almost all areas. Thanks to their profile construction, they are ideally suited for the cover cut edges.

AU-01-05

flat U-profile | 5 mm
for LED stripes up to 5,7 mm width

item	colour	dimensions L	price
970080	aluminium anodized	1m	7,95 €
970081	aluminium anodized	2m	17,95 €
970083	black	2m	15,95 €
970085	white	2m	15,95 €

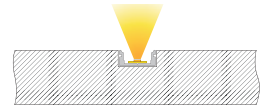
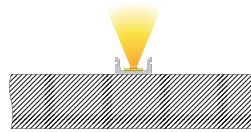
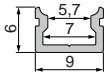
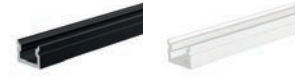

AU-02-05

high U-profile | 5 mm
for LED stripes up to 5,7 mm width

item	colour	dimensions L	price
970180	aluminium anodized	1m	9,95 €
970181	aluminium anodized	2m	18,95 €
970183	black	2m	18,95 €
970185	white	2m	18,95 €

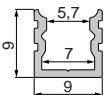







covers | PMMA [polymethylmethacrylat]
for 5 mm profiles







	clear	mat	milky
			
1m	983550		983554 5,95 €
2m	983551		983555 11,95 €
3m			983556 18,95€







			
1m			984054 5,95 €
2m			984055 11,95 €

			
1m			984554 5,95 €
2m			984555 11,95 €

end caps set | 2 pieces **4,95 €**
for 5 mm profiles

			
			
white	978660		978670
grey	978661		978671
black	978662		978672

			
			
white	979160		979170
grey	979161		979171
black	979162		979172

			
			
white	979660		979670
grey	979661		979671
black	979662		979672

930345 3M double-sided tape | 50 m x 8 mm

19,95 €

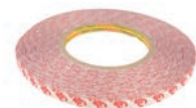

AU-01-08

flat U-profile | 8 mm
for LED stripes up to 9,3 mm width

item	colour	dimensions L	price
970000	aluminium anodized	1m	11,95 €
970001	aluminium anodized	2m	23,95 €
970008	aluminium anodized	3m	35,95 €
970003	black	2m	23,95 €
970005	white	2m	23,95 €
970007	aluminium brushed	2m	23,95 €

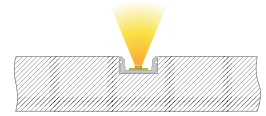
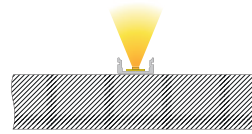
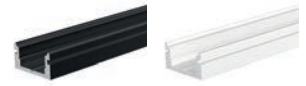
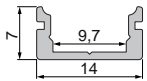

AU-02-08

high U-profile | 8 mm
for LED stripes up to 9,3 mm width

item	colour	dimensions L	price
970100	aluminium anodized	1m	14,95 €
970101	aluminium anodized	2m	28,95 €
970108	aluminium anodized	3m	42,95 €
970103	black	2m	28,95 €
970105	white	2m	28,95 €

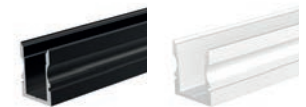
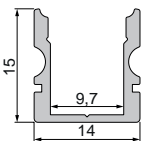

covers | PMMA [polymethylmethacrylat]
for 8 mm profiles

	clear	mat	milky	
				
1m	983000	983002	983004	7,95 €
2m	983001	983003	983005	17,95 €
3m	983006	983007	983008	25,95 €





				
1m	983500	983502	983504	7,95 €
2m	983501	983503	983505	17,95 €
3m		983506	983508	25,95 €

				
1m		984002	984004	7,95 €
2m		984003	984005	17,95 €

				
1m		984502	984504	7,95 €
2m		984503	984505	17,95 €

end caps set | 2 pieces **4,95 €**
for 8 mm profiles

			
			
			
			
white	978000		978040
grey	978001		978041
black	978002		978042

			
			
			
			
white	978500		978540
grey	978501		978541
black	978502		978542

			
			
			
			
white	979080		979100
grey	979081		979101
black	979082		979102

			
			
			
			
white	979580		979600
grey	979581		979601
black	979582		979602

987002 fixation clamp 08 | set consisting of 2 pieces **3,95 €**



987080 universal mounting clip brackets [pivotable] set, 2 pieces | matching fixation clamp must be ordered separately **23,95 €**



930347 3M double-sided tape | 50 m x 12 mm **23,95 €**

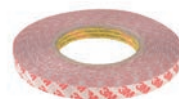

AU-01-10

flat U-profile | 10 mm
for LED stripes up to 11,3 mm width

item	colour	dimensions L	price
970020	aluminium anodized	1m	11,95 €
970021	aluminium anodized	2m	23,95 €
970028	aluminium anodized	3m	35,95 €
970029	aluminium anodized	4m	49,95 €
970023	black	2m	23,95 €
970025	white	2m	23,95 €
970027	aluminium brushed	2m	23,95 €

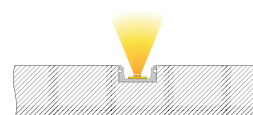
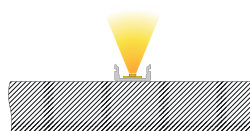
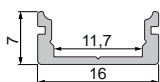
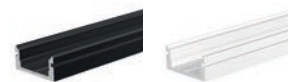



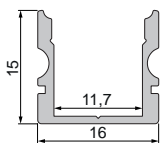
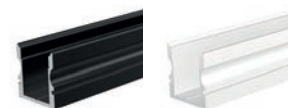

AU-02-10

high U-profile | 10 mm
for LED stripes up to 11,3 mm width































item	colour	dimensions L	price
970120	aluminium anodized	1m	14,95 €
970121	aluminium anodized	2m	28,95 €
970128	aluminium anodized	3m	44,95 €
970129	aluminium elovxiert	4m	59,95 €
970123	black	2m	28,95 €
970125	white	2m	28,95 €



covers | PMMA [polymethylmethacrylat]
for 10 mm profiles

	clear	mat	milky	
				
1m	983010	983012	983014	7,95 €
2m	983011	983013	983015	17,95 €
3m	983016	983017	983018	25,95 €
4m	983060	983061	983062	33,95 €
				
1m	983510	983512	983514	7,95 €
2m	983511	983513	983515	17,95 €
3m	983516	983517	983518	25,95 €
4m	983560	983561	983562	33,95 €
				
1m		984012	984014	7,95 €
2m		984013	984015	17,95 €
3m		984017	984018	25,95 €
4m		984010	984011	33,95 €
				
1m		984512	984514	7,95 €
2m		984513	984515	17,95 €
3m		984517	984518	25,95 €
4m		984510	984511	33,95 €
				
1m	985010			7,95 €
2m	985011			17,95 €
3m	985016			25,95 €

end caps set | 2 pieces **4,95 €**
for 10 mm profiles

	white	grey	black					
								
	978010	978011	978012		978010		978050	
								
	978510	978511	978512		978510		978550	
								
	979000	979001	979002		979000		979020	
								
	979500	979501	979502		979500		979520	
								
	980000	980001	980002		980000		980010	

987004 fixation clamp 10 | set consisting of 2 pieces **3,95 €**



987080 universal mounting clip brackets [pivotable] set, 2 pieces | matching fixation clamp must be ordered separately **23,95 €**



930348 3M double-sided tape | 50 m x 15 mm **26,95 €**

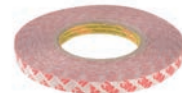

AU-01-12

flat U-profile | 12 mm
for LED stripes up to 13,3 mm width

item	colour	dimensions L	price
970040	aluminium anodized	1m	14,95 €
970041	aluminium anodized	2m	28,95 €
970048	aluminium anodized	3m	42,95 €
970043	black	2m	28,95 €
970045	white	2m	28,95 €
970047	aluminium brushed	2m	28,95 €

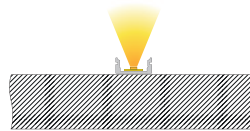
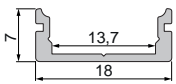



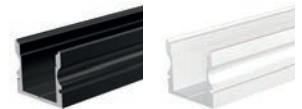
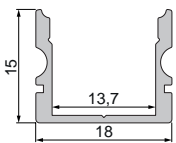

AU-02-12

high U-profile | 12 mm
for LED stripes up to 13,3 mm width











































item	colour	dimensions L	price
970140	aluminium anodized	1m	15,95 €
970141	aluminium anodized	2m	31,95 €
970148	aluminium anodized	3m	44,95 €
970143	black	2m	31,95 €
970145	white	2m	31,95 €
970147	aluminium brushed	2m	31,95 €



covers | PMMA [polymethylmethacrylat]
for 12 mm profiles

	clear	mat	milky	
				
1m	983020	983022	983024	7,95 €
2m	983021	983023	983025	17,95 €
3m	983028	983027	983026	25,95 €
				
1m	983520	983522	983524	7,95 €
2m	983521	983523	983525	17,95 €
3m	983527		983526	25,95 €
				
1m		984022	984024	7,95 €
2m		984023	984025	17,95 €
3m			984026	25,95 €
				
1m		984522	984524	7,95 €
2m		984523	984525	17,95 €
3m			984526	25,95 €

end caps set | 2 pieces **4,95 €**
for 12 mm profiles

		white	978020		grey	978021	
		grey	978022		black	978022	
		white	978060		grey	978061	
		grey	978062		black	978062	
		white	978520		grey	978521	
		grey	978522		black	978522	
		white	979010		grey	979011	
		grey	979012		black	979012	
		white	979030		grey	979031	
		grey	979032		black	979032	
		white	979510		grey	979511	
		grey	979512		black	979512	
		white	979530		grey	979531	
		grey	979532		black	979532	

987006 fixation clamp 12 | set consisting of 2 pieces **3,95 €**



987080 universal mounting clip brackets [pivotable] set, 2 pieces | matching fixation clamp must be ordered separately **23,95 €**



930348 3M double-sided tape | 50 m x 15 mm **26,95 €**

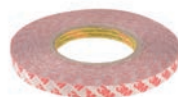

AU-01-15

flat U-profile | 15 mm
for LED stripes up to 16,3 mm width

item	colour	dimensions L	price
970060	aluminium anodized	1m	14,95 €
970061	aluminium anodized	2m	28,95 €
970068	aluminium anodized	3m	42,95 €
970063	black	2m	28,95 €
970065	white	2m	28,95 €

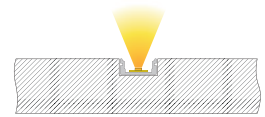
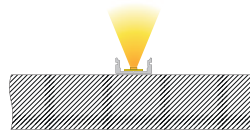
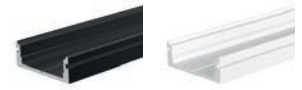
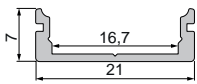

AU-02-15

high U-profile | 15 mm
for LED stripes up to 16,3 mm width

item	colour	dimensions L	price
970160	aluminium anodized	1m	15,95 €
970161	aluminium anodized	2m	31,95 €
970168	aluminium anodized	3m	44,95 €
970163	black	2m	31,95 €
970165	white	2m	31,95 €

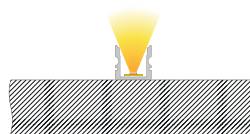
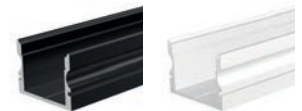
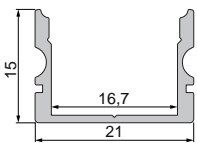

covers | PMMA [polymethylmethacrylat]
for 15 mm profiles

	clear	mat	milky	
				
1m	983030	983032	983034	9,95 €
2m	983031	983033	983035	19,95 €
3m	983038	983037	983036	28,95 €

				
1m	983530	983532	983534	9,95 €
2m	983531	983533	983535	19,95 €
3m		983539	983536	28,95 €

				
1m		984032	984034	9,95 €
2m		984033	984035	19,95 €
3m			984036	28,95 €

				
1m		984532	984534	9,95 €
2m		984533	984535	19,95 €

end caps set | 2 pieces **4,95 €**
for 15 mm profiles

-  white
-  grey
-  black

			
978030	978031	978070	978071
978032	978072		

-  white
-  grey
-  black

			
978530	978531	978570	978571
978532	978572		

-  white
-  grey
-  black

			
979090	979091	979110	979111
979092	979112		

-  white
-  grey
-  black

			
979590	979591	979610	979611
979592	979612		

987008 fixation clamp 15 | set consisting of 2 pieces **3,95 €**



987080 universal mounting clip brackets [pivotable] set, 2 pieces | matching fixation clamp must be ordered separately **23,95 €**



930349 3M double-sided tape | 50 m x 20 mm **34,95 €**



AU-02-20

high U-profile | 20 mm
for LED stripes up to 21,3 mm width

item	colour	dimensions L	price
970201	aluminium anodized	2m	37,95 €
970202	aluminium anodized	3m	59,95 €

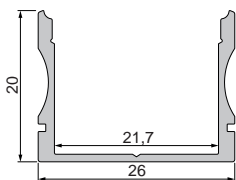

With the kind support of Friese Elektrotechnik, Ettenheim

covers | PMMA [polymethylmethacrylat]
for 20 mm profiles

clear mat milky



1m **983040** **983044** **11,50 €**

2m **983041** **983045** **21,95 €**

3m **983046** **983046** **32,95 €**



1m **984044** **11,50 €**

2m **984045** **21,95 €**



1m **984544** **11,50 €**

2m **984545** **21,95 €**

end caps set | 2 pieces **4,95 €**
for 20 mm profiles

grey

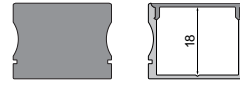

978161

grey

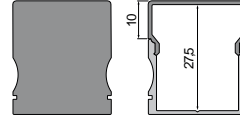

978351

grey

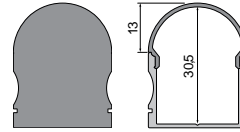

978361

987010 fixation clamp 20 | set consisting of 2 pieces

3,95 €

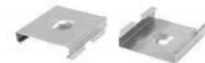

987080 universal mounting clip brackets [pivotable]
set, 2 pieces | matching fixation clamp
must be ordered separately

23,95 €



930350 3M double-sided tape | 50 m x 25 mm

42,95 €

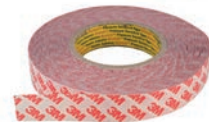

ET-01-05

flat built-in-T-profile | 5 mm
for LED stripes up to 5,7 mm width

item	colour	dimensions L	price
975081	aluminium anodized	2m	17,95 €
975083	black	2m	17,95 €
975085	white	2m	17,95 €

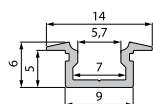
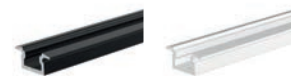

ET-02-05

high built-in-T-profile | 5 mm
for LED stripes up to 5,7 mm width

item	colour	dimensions L	price
975181	aluminium anodized	2m	19,95 €
975183	black	2m	19,95 €
975185	white	2m	19,95 €

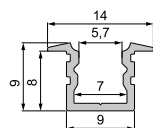
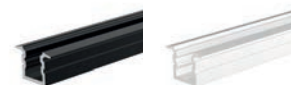







covers | PMMA [polymethylmethacrylat]
for 5 mm profiles







	clear	mat	milky
			
1m	983550		983554 5,95 €
2m	983551		983555 11,95 €
3m			983556 18,95€







			
1m		984054	5,95 €
2m		984055	11,95 €

			
1m		984554	5,95 €
2m		984555	11,95 €

end caps set | 2 pieces **4,95 €**
for 5 mm profiles

			
	white	978680	978690
	grey	978681	978691
	black	978682	978692

			
	white	979180	979190
	grey	979181	979191
	black	979182	979192

			
	white	979680	979690
	grey	979681	979691
	black	979682	979692

930345 3M double-sided tape | 50 m x 8 mm

19,95 €

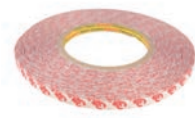

ET-01-08

flat built-in-T-profile | 8 mm
for LED stripes up to 9,3 mm width

item	colour	dimensions L	price
975001	aluminium anodized	2m	26,95 €
975008	aluminium anodized	3m	38,95 €
975003	black	2m	26,95 €
975005	white	2m	26,95 €

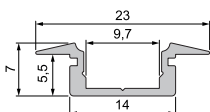
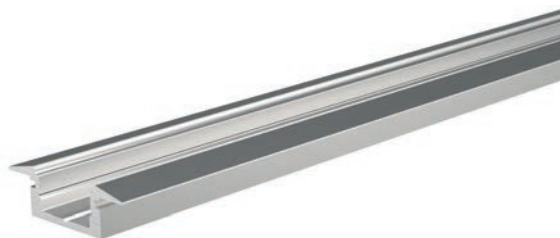

ET-02-08

high built-in-T-profile | 8 mm
for LED stripes up to 9,3 mm width

item	colour	dimensions L	price
975101	aluminium anodized	2m	31,95 €
975108	aluminium anodized	3m	44,95 €
975103	black	2m	31,95 €
975105	white	2m	31,95 €

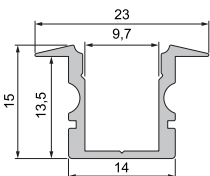
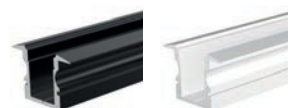

covers | PMMA [polymethylmethacrylat]
for 8 mm profiles

	clear	mat	milky	
				
1m	983000	983002	983004	7,95 €
2m	983001	983003	983005	17,95 €
3m	983006	983007	983008	25,95 €

				
1m	983500	983502	983504	7,95 €
2m	983501	983503	983505	17,95 €
3m			983506	25,95 €

				
1m		984002	984004	7,95 €
2m		984003	984005	17,95 €

				
1m		984502	984504	7,95 €
2m		984503	984505	17,95 €

end caps set | 2 pieces **4,95 €**
for 8 mm profiles

	white	978080
	grey	978081
	black	978082

	white	978580
	grey	978581
	black	978582

	white	979120
	grey	979121
	black	979122

	white	979620
	grey	979621
	black	979622

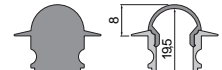
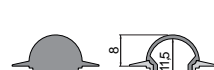
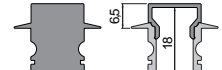
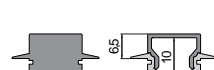
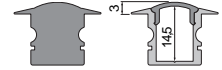
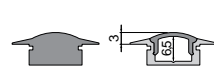
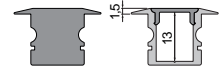
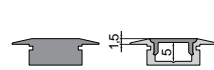

987002 fixation clamp 08 | set consisting of 2 pieces **3,95 €**



987080 universal mounting clip brackets [pivotable] set, 2 pieces | matching fixation clamp must be ordered separately **23,95 €**



930347 3M double-sided tape | 50 m x 12 mm **23,95 €**



ET-01-10

flat built-in-T-profile | 10 mm
for LED stripes up to 11,3 mm width

item	colour	dimensions L	price
975021	aluminium anodized	2m	26,95 €
975028	aluminium anodized	3m	38,95 €
975029	aluminium anodized	4m	53,95 €
975023	black	2m	26,95 €
975025	white	2m	26,95 €

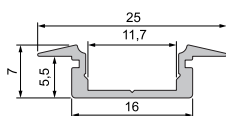
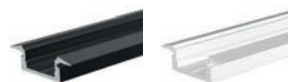
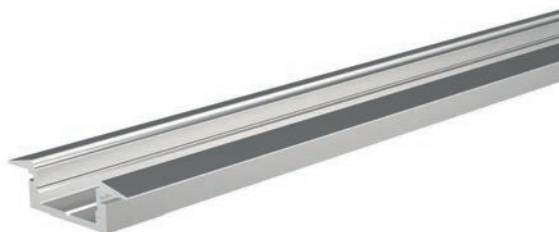



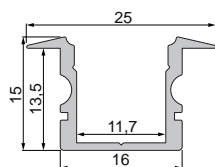
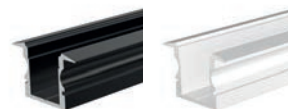
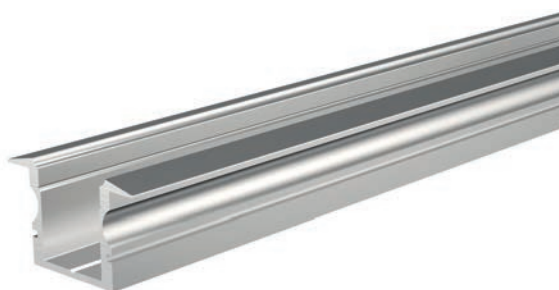

ET-02-10

high built-in-T-profile | 10 mm
for LED stripes up to 11,3 mm width







item	colour	dimensions L	price
975121	aluminium anodized	2m	31,95 €
975128	aluminium anodized	3m	44,95 €
975129	aluminium anodized	4m	64,95 €
975123	black	2m	31,95 €
975125	white	2m	31,95 €



covers | PMMA [polymethylmethacrylat] for 10 mm profiles

	clear	mat	milky	
				
1m	983010	983012	983014	7,95 €
2m	983011	983013	983015	17,95 €
3m	983016	983017	983018	25,95 €
4m	983060	983061	983062	33,95 €
				
1m	983510	983512	983514	7,95 €
2m	983511	983513	983515	17,95 €
3m	983516	983517	983518	25,95 €
4m	983560	983561	983562	33,95 €
				
1m		984012	984014	7,95 €
2m		984013	984015	17,95 €
3m		984017	984018	25,95 €
4m		984010	984011	33,95 €
				
1m		984512	984514	7,95 €
2m		984513	984515	17,95 €
3m		984517	984518	25,95 €
4m		984510	984511	33,95 €
				
1m	985010			7,95 €
2m	985011			17,95 €
3m	985016			25,95 €

end caps set | 2 pieces **4,95 €**
for 10 mm profiles

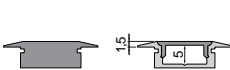
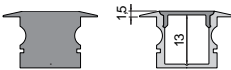
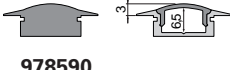
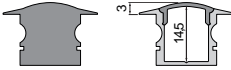
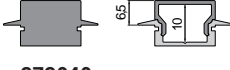
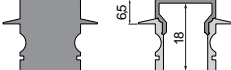
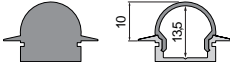
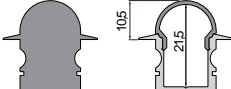
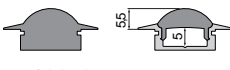
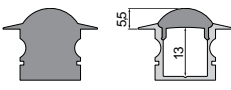
	white	grey	black		white	grey	black	
								
	978090	978091	978092		978130	978131	978132	
	978590	978591	978592		978630	978631	978632	
	979040	979041	979042		979060	979061	979062	
	979540	979541	979542		979560	979561	979562	
	980040	980041	980042		980060	980061	980062	

987004 fixation clamp 10 | set consisting of 2 pieces **3,95 €**



987080 universal mounting clip brackets [pivotable] set, 2 pieces | matching fixation clamp must be ordered separately **23,95 €**



930348 3M double-sided tape | 50 m x 15 mm **26,95 €**

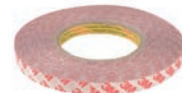

ET-01-12

flat built-in-T-profile | 12 mm
for LED stripes up to 13,3 mm width

item	colour	dimensions L	price
975041	aluminium anodized	2m	31,95 €
975043	black	2m	31,95 €
975045	white	2m	31,95 €

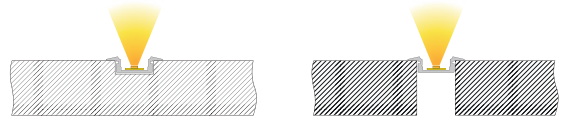
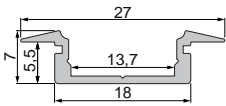
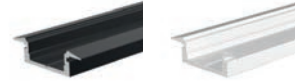
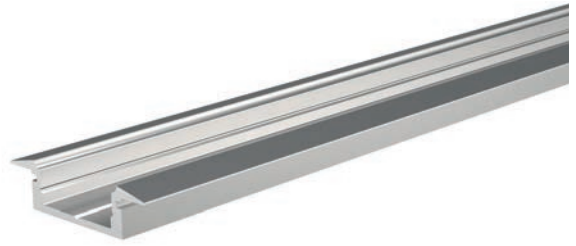



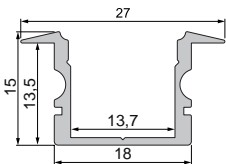
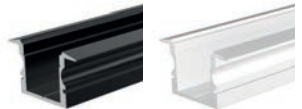
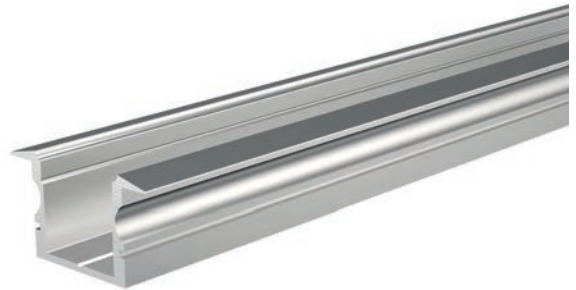

ET-02-12

high built-in-T-profile | 12 mm
for LED stripes up to 13,3 mm width



item	colour	dimensions L	price
975141	aluminium anodized	2m	35,95 €
975148	aluminium anodized	3m	54,95 €
975143	black	2m	35,95 €
975145	white	2m	35,95 €



covers | PMMA [polymethylmethacrylat]
for 12 mm profiles

	clear	mat	milky	
				
1m	983020	983022	983024	7,95 €
2m	983021	983023	983025	17,95 €
3m	983028	983027	983026	25,95 €
				
1m	983520	983522	983524	7,95 €
2m	983521	983523	983525	17,95 €
3m	983527		983526	25,95 €
				
1m		984022	984024	7,95 €
2m		984023	984025	17,95 €
3m			984026	25,95 €
				
1m		984522	984524	7,95 €
2m		984523	984525	17,95 €
3m			984526	25,95 €

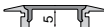
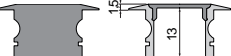
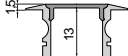
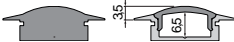
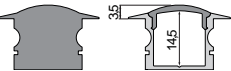
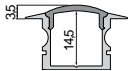
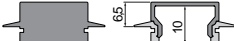
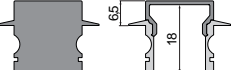
end caps set | 2 pieces **4,95 €**
for 12 mm profiles

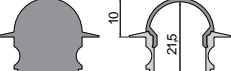
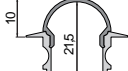
	white	grey	black
			
	978100	978101	978140
			
			17,95 €
			978141
			978142
			
	978600	978601	978640
			
			17,95 €
			978641
			978642
			
	979050	979051	979070
			
			17,95 €
			979071
			979072
			
	979550	979551	979570
			
			17,95 €
			979571
			979572

987006 fixation clamp 12 | set consisting of 2 pieces **3,95 €**



987080 universal mounting clip brackets [pivotable] set, 2 pieces | matching fixation clamp must be ordered separately **23,95 €**



930348 3M double-sided tape | 50 m x 15 mm **26,95 €**



ET-01-15

flat built-in-T-profile | 15 mm
for LED stripes up to 16,3 mm width

item	colour	dimensions L	price
975061	aluminium anodized	2m	31,95 €
975063	black	2m	31,95 €
975065	white	2m	31,95 €

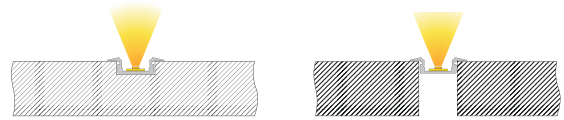
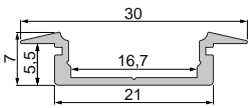
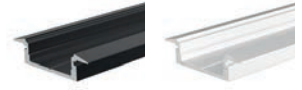
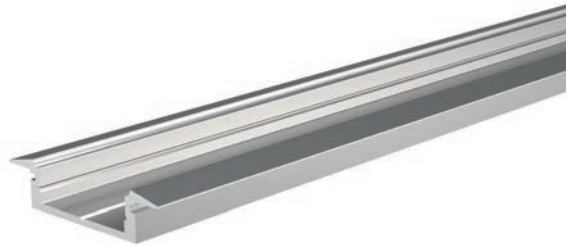

ET-02-15

high built-in-T-profile | 15 mm
for LED stripes up to 16,3 mm width

item	colour	dimensions L	price
975161	aluminium anodized	2m	35,95 €
975168	aluminium anodized	3m	54,95 €
975163	black	2m	35,95 €
975165	white	2m	35,95 €

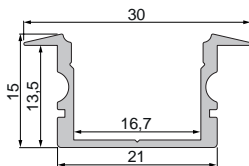
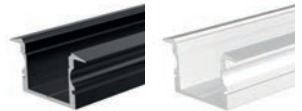
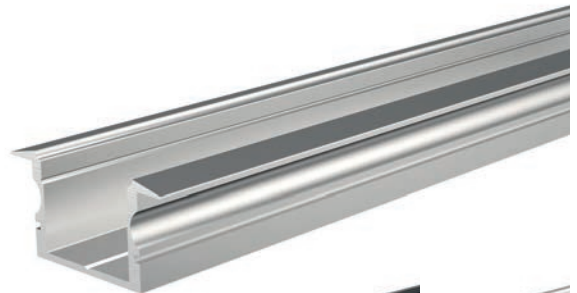

covers | PMMA [polymethylmethacrylat]
for 15 mm profiles





	clear	mat	milky	
				
1m	983030	983032	983034	9,95 €
2m	983031	983033	983035	19,95 €
3m	983038	983037	983036	28,95 €



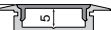

	clear	mat	milky	
				
1m	983530	983532	983534	9,95 €
2m	983531	983533	983535	19,95 €
3m		983539	983536	28,95 €

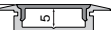

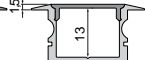
	clear	mat	milky	
				
1m		984032	984034	9,95 €
2m		984033	984035	19,95 €
3m			984036	28,95 €



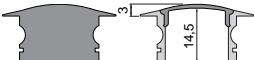

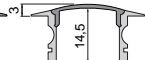

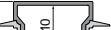
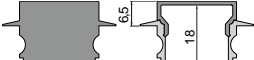
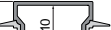
	clear	mat	milky	
				
1m		984532	984534	9,95 €
2m		984533	984535	19,95 €

end caps set | 2 pieces **4,95 €**
for 15 mm profiles

	white	grey	black
			
			
1m	978110	978111	978112
	978150	978151	978152

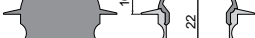
	white	grey	black
			
			
1m	978610	978611	978612
	978650	978651	978652

	white	grey	black
			
			
1m	979130	979131	979132
	979150	979151	979152

	white	grey	black
			
			
1m	979630	979631	979632
	979650	979651	979652

987008 fixation clamp 15 | set consisting of 2 pieces **3,95 €**



987080 universal mounting clip brackets [pivotable] set, 2 pieces | matching fixation clamp must be ordered separately **23,95 €**



930349 3M double-sided tape | 50 m x 20 mm **34,95 €**

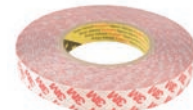





With the kind support of BEST/Bellemann Elektro Service Team GmbH, Rauenberg-Malschenberg

H- und groove-profiles

Groove and H-profiles are offered with a comprehensive range of mounting accessories and are hard to beat in terms of versatility. The range of accessories includes cable suspensions, tension springs, sliding blocks and much more.

AH-01-20

H-profile with cooling fins and mounting profile | 20 mm for LED stripes up to 21,3 mm width



item	colour	dimensions L	price
970261	aluminium anodized	2m	46,95 €
970262	aluminium anodized	3m	74,95 €

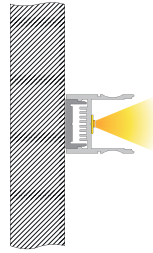
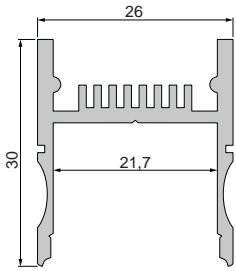

With the kind support of BEST Bellemann Elektro Service Team GmbH, Rauenberg-Malschenberg

covers | PMMA [polymethylmethacrylat]
for 20 mm profiles

clear mat milky



1m	983040	983044	11,50 €
2m	983041	983045	21,95 €
3m		983046	32,95 €



1m		984044	11,50 €
2m		984045	21,95 €



1m		984544	11,50 €
2m		984545	21,95 €

end caps set | 2 pieces **4,95 €**
for 20 mm profiles

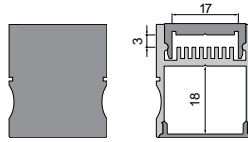

grey **978311**

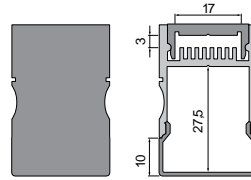

grey **979241**

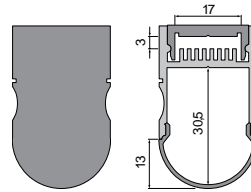

grey **979741**

MOUNTING / CARRIER PROFILE FOR H-PROFILE 20 MM

for AH-01-20

970770  1m aluminium natural **11,95 €**

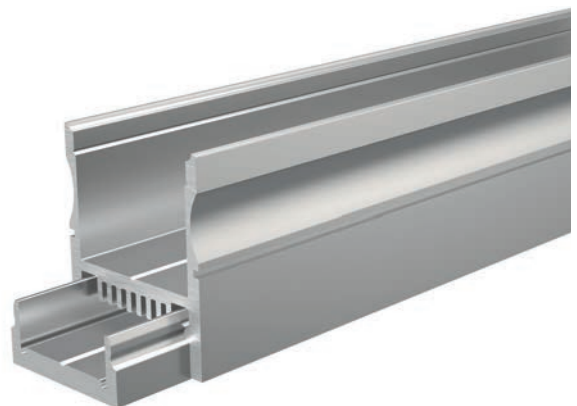
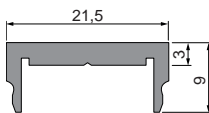

930650 screws set, incl. each 10 pieces
6 x 35 mm nylon dowels
4,5 x 45 mm stainless steel screw

7,95 €



AU-03-12

groove profiles for pendulum | 12 mm | suitable for rope suspension
for LED stripes up to 13,3 mm width

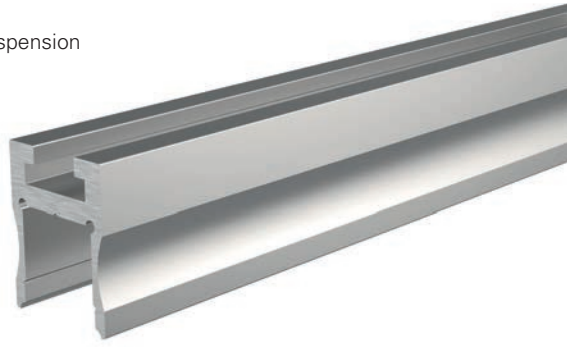

item	colour	dimensions L	price
970231	aluminium anodized	2m	37,95 €

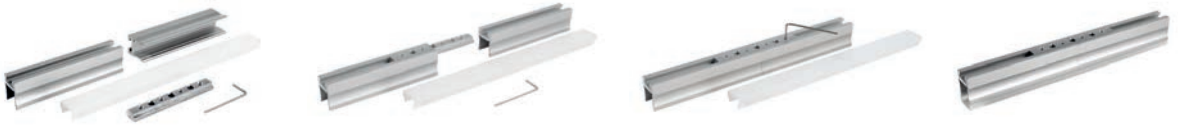
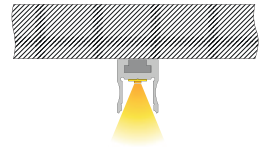
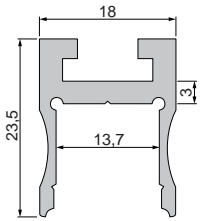



With the kind support of Friese Elektrotechnik, Ettenheim

covers | PMMA [polymethylmethacrylat]
for 12 mm profiles

clear mat milky

					
1m	983020	983022	983024	7,95 €	
2m	983021	983023	983025	17,95 €	
3m	983028	983027	983026	25,95 €	

					
1m	983520	983522	983524	7,95 €	
2m	983521	983523	983525	17,95 €	
3m	983527		983526	25,95 €	

					
1m		984022	984024	7,95 €	
2m		984023	984025	17,95 €	
3m			984026	25,95 €	

					
1m		984522	984524	7,95 €	
2m		984523	984525	17,95 €	
3m			984526	25,95 €	

end caps set | 2 pieces **4,95 €**
for 12 mm profiles

 grey



978291

 grey

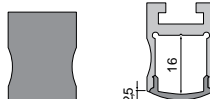

978711

 grey

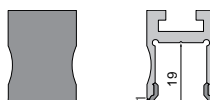

979221

 grey



979721

987060 wire suspension, pivotable, 2m | set | 2 pieces
For the installation of the wire suspension you need, depending on the profile, the universal sliding block 987020.

35,95 €



987020 universal sliding block/straight connector set | 2 pieces

7,95 €



ET-04-12

groove-built-in-T-profile | 12 mm
for LED stripes up to 13,3 mm width



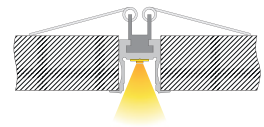
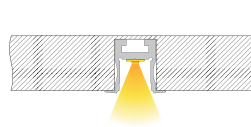
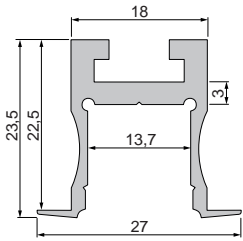

item	colour	dimensions L	price
975231	aluminium anodized	2m	39,95 €





covers | PMMA [polymethylmethacrylat]
for 12 mm profiles

clear mat milky

				
1m	983020	983022	983024	7,95 €
2m	983021	983023	983025	17,95 €
3m	983028	983027	983026	25,95 €

				
1m	983520	983522	983524	7,95 €
2m	983521	983523	983525	17,95 €
3m	983527		983526	25,95 €

				
1m		984022	984024	7,95 €
2m		984023	984025	17,95 €
3m			984026	25,95 €

				
1m		984522	984524	7,95 €
2m		984523	984525	17,95 €
3m			984526	25,95 €

end caps set | 2 pieces **4,95 €**
for 12 mm profiles

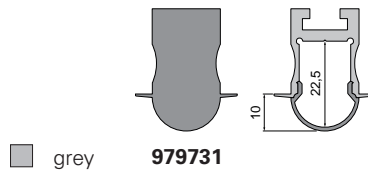
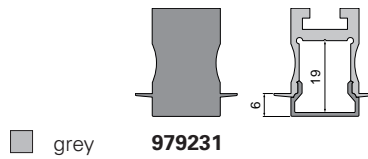
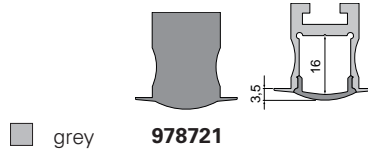

end caps set | 2 pieces | aluminium **21,95 €**



987040 sliding block with springsset
set | 2 pieces

7,95 €

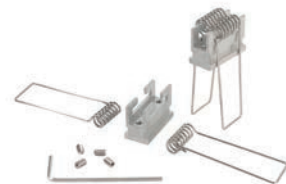

987020 universal sliding block/straight connector
set | 2 pieces

7,95 €



AU-10-12

groove-U-profile | 12 mm
for LED stripes up to 13 mm width



item	colour	dimensions L	price
970280	aluminium anodized	2m	35,95 €
970281	aluminium anodized	3m	54,95 €
970284	white	2m	35,95 €
970285	white	3m	54,95 €

- multifunction
- pendulum
- concealed mounting
- extendable through corner / longitudinal connectors

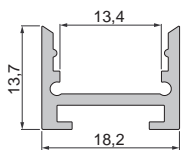
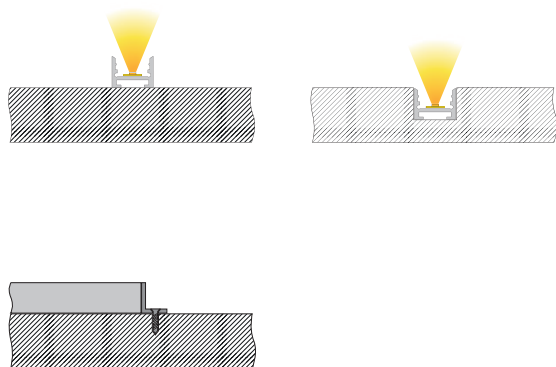

With the kind support of Friese Elektrotechnik, Ettenheim

covers | PMMA [polymethylmethacrylat]
for 12 mm profiles

clear mat milky



2m	983090	23,95 €
3m	983091	35,95 €

end caps set | 2 pieces | aluminium **19,95 €**
for 12 mm profiles

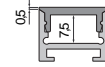

 silver **980020**



 silver **980021**

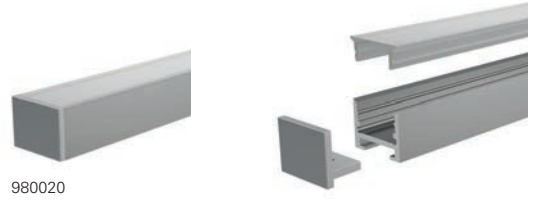

980020

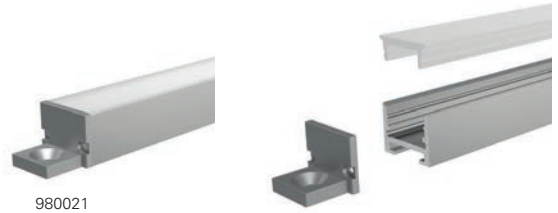

980021

980023 mountings clip | Set | 2 pieces **4,95 €**



987025 sliding block | straight connector **9,95 €**



987026 sliding block | 120° corner connector **9,95 €**



987027 sliding block | 90° corner connector **9,95 €**





With the kind support of Albtherme Waldbronn / Ziegler Technics buer@ziegler-technics.de



step-, socket-, angle-, corner-profiles

The perfect light is not always planned from the very start. With the mounting and corner profiles, you can also integrate linear light at a later stage.

AL-01-10

step-profile | 10 mm
for LED stripes up to 11,3 mm width

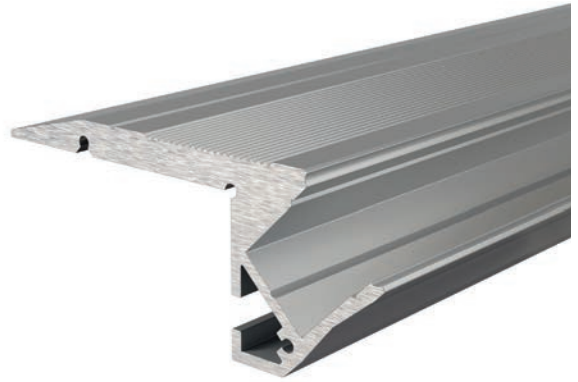

item	colour	dimensions L	price
970503	aluminium anodized	2m	59,95 €
970502	aluminium anodized	3m	94,95 €

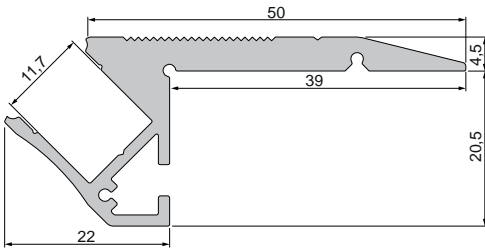

With the kind support of SH-Lichttechnik, Pfullingen und Becks Reutlingen

covers | PMMA [polymethylmethacrylat]
for 10 mm profiles

clear mat milky



1m	983010	983012	983014	7,95 €
2m	983011	983013	983015	17,95 €
3m	983016	983017	983018	25,95 €
4m	983060	983061	983062	33,95 €



walkable | PC [polycarbonate]

1m		983080	11,50 €
2m		983081	21,95 €
3m		983082	32,95 €

end caps set | right + left **4,95 €**
for 10 mm profiles



■ grey

978191

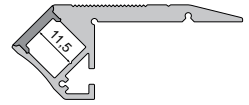
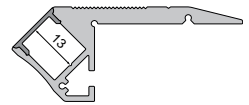

930650 screws set, incl. each 10 pieces
6 x 35 mm nylon dowels
4,5 x 45 mm stainless steel screw

7,95 €



AL-02-10

step-profile | 10 mm

for LED stripes up to 11,3 mm width



item	colour	dimensions L	price
970520	aluminium anodized	1m	30,95 €
970523	aluminium anodized	2m	59,95 €
970522	aluminium anodized	3m	94,95 €

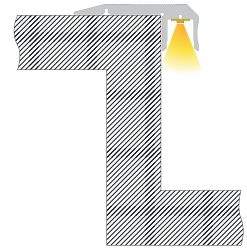
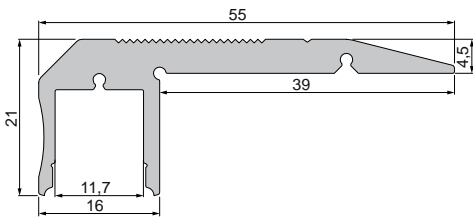

With the kind support of Elektro Grün, Neustadt an der Weinstraße

covers | PMMA [polymethylmethacrylat]
for 10 mm profiles

clear mat milky



1m	983010	983012	983014	7,95 €
2m	983011	983013	983015	17,95 €
3m	983016	983017	983018	25,95 €
4m	983060	983061	983062	33,95 €

end caps set | right + left **4,95 €**
for 10 mm profiles

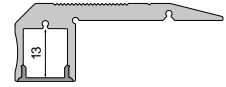
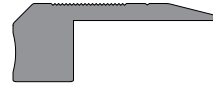

■ grey

978201

930650 screws set, incl. each 10 pieces
6 x 35 mm nylon dowels
4,5 x 45 mm stainless steel screw

7,95 €



AV-01-20

angle-profile 45° for coving | with cooling fins on one side | 22 mm
for LED stripes up to 22 mm width



item	colour	dimensions L	price
970460	aluminium anodized	2m	35,95 €

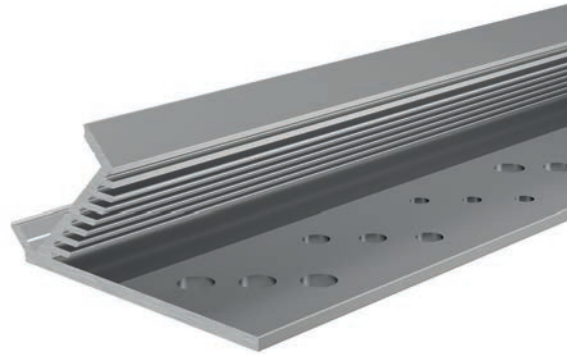
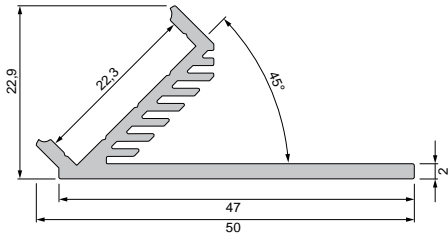

pre-punched drill / screw holes [Ø 3; 4 und 5 mm]
for easier mounting

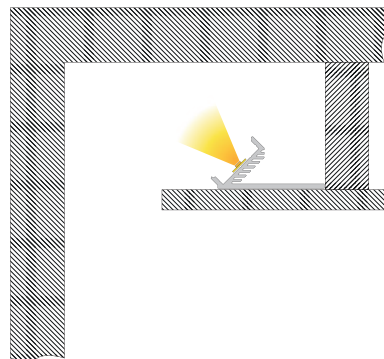
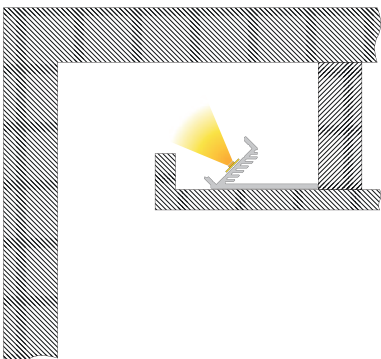
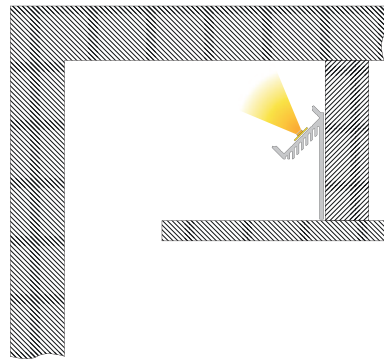
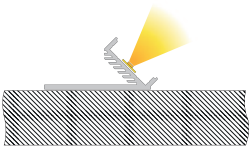

covers | PMMA [polymethylmethacrylat]
for 22 mm profiles

clear mat milky



1m	983040	983044	11,50 €
2m	983041	983045	21,95 €
3m		983046	32,95 €

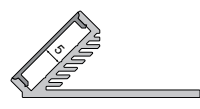

1m		984044	11,50 €
2m		984045	21,95 €

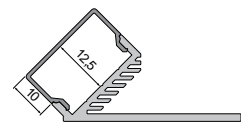

1m		984544	11,50 €
2m		984545	21,95 €

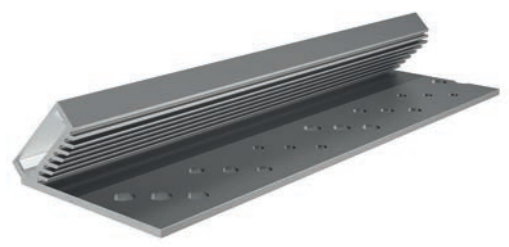
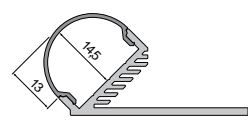

930105 310ml cartridge, white | glue+sealing power

35,95 €



930350 3M double-sided tape | 50 m x 25 mm

42,95 €

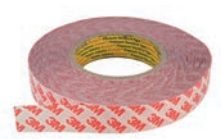

930650 screws set, incl. each 10 pieces
6 x 35 mm nylon dowels
4,5 x 45 mm stainless steel screw

7,95 €



AV-02-20

angle-profile 135° for coving | double-sided | 20 mm
for LED stripes up to 22 / 17 mm width

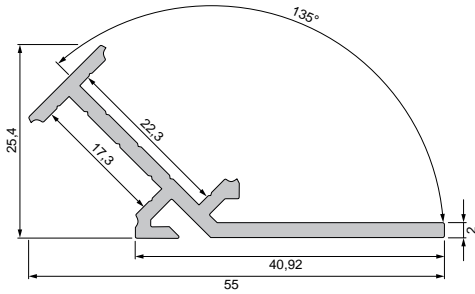

item	colour	dimensions L	price
970470	aluminium anodized	2m	35,95 €

pre-punched drill / screw holes [Ø 3; 4 und 5 mm]
for easier mounting

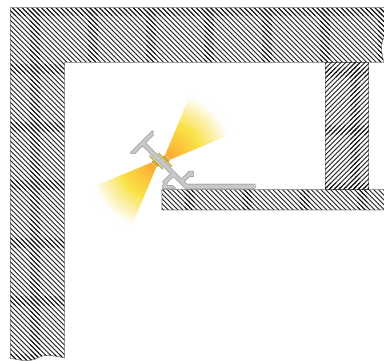
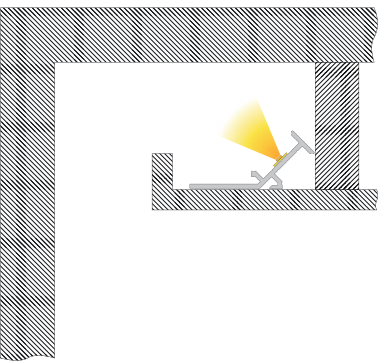
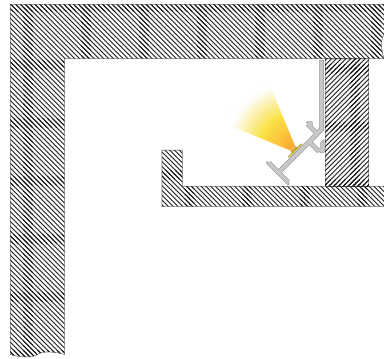
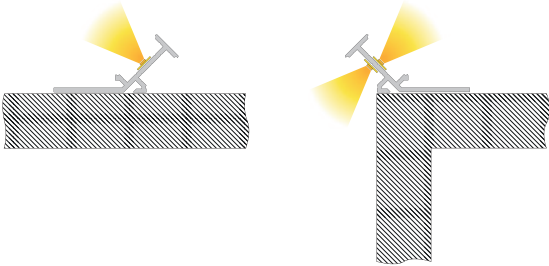

20er covers | PMMA [polymethylmethacrylat]

clear mat milky

			
1m	983040	983044	11,50 €
2m	983041	983045	21,95 €
3m		983046	32,95 €

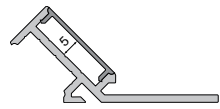

			
1m		984044	11,50 €
2m		984045	21,95 €

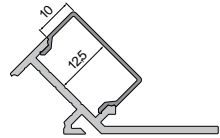

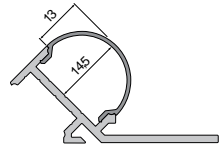

			
1m		984544	11,50 €
2m		984545	21,95 €



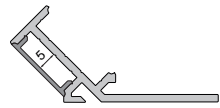

15er covers | PMMA [polymethylmethacrylat]

				
1m	983030	983032	983034	9,95 €
2m	983031	983033	983035	19,95 €
3m	983038	983037	983036	28,95 €

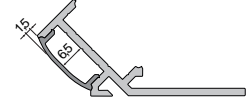

				
1m	983530	983532	983534	9,95 €
2m	983531	983533	983535	19,95 €
3m		983539	983536	28,95 €



				
1m		984032	984034	9,95 €
2m		984033	984035	19,95 €
3m			984036	28,95 €

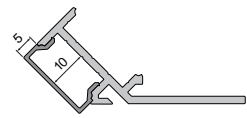

				
1m		984532	984534	9,95 €
2m		984533	984535	19,95 €

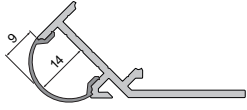

930105 310ml cartridge, white | glue+sealing power

35,95 €



930350 3M double-sided tape | 50 m x 25 mm

42,95 €

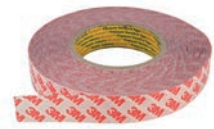

930650 screws set, incl. each 10 pieces
6 x 35 mm nylon dowels
4,5 x 45 mm stainless steel screw

7,95 €



AM-02-10

socket-profile | 10 mm
for LED stripes up to 11,3 mm width

item	colour	dimensions L	price
970602	aluminium anodized	2m	82,95 €
970600	aluminium anodized	3m	124,95 €
970601	black	3m	124,95 €

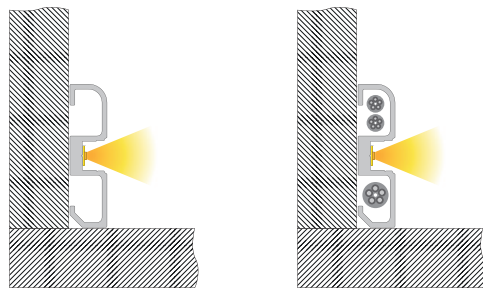
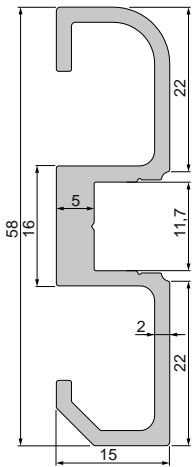

covers | PMMA [polymethylmethacrylat]
for 10 mm profiles

clear mat milky



1m	983010	983012	983014	7,95 €
2m	983011	983013	983015	17,95 €
3m	983016	983017	983018	25,95 €
4m	983060	983061	983062	33,95 €



1m	983510	983512	983514	7,95 €
2m	983511	983513	983515	17,95 €
3m	983516	983517	983518	25,95 €
4m	983560	983561	983562	33,95 €



1m		984012	984014	7,95 €
2m		984013	984015	17,95 €
3m		984017	984018	25,95 €
4m		984010	984011	33,95 €

end caps set | right + left **4,95 €**

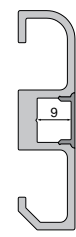
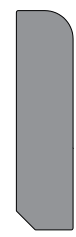

grey **978241**
black **978242**

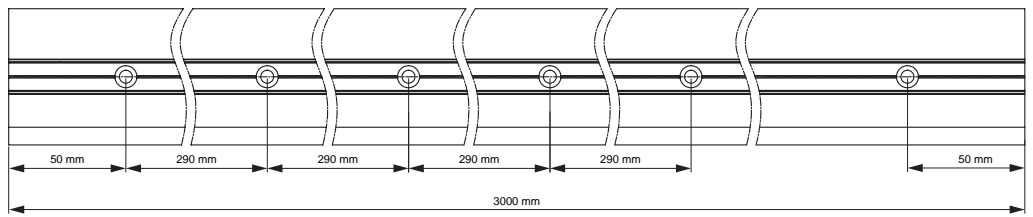
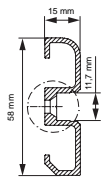
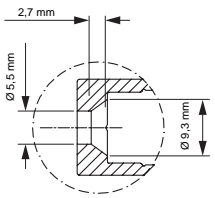

930650 screws set, incl. each 10 pieces
6 x 35 mm nylon dowels
4,5 x 45 mm stainless steel screw

7,95 €



AM-01-10

built-on / substructure-profile | ultraflach, H: 7 mm | 10 mm
for LED stripes up to 11,3 mm width



item	colour	dimensions L	price
970301	aluminium anodized	2m	37,95 €
970308	aluminium anodized	3m	59,95 €
970303	black	2m	37,95 €
970305	white	2m	37,95 €

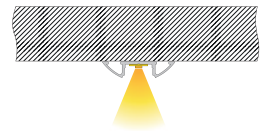
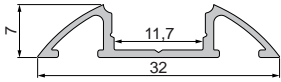

With the kind support of BEST Bellemann Elektro Service Team GmbH, Rauenberg-Malschenberg

covers | PC [polycarbonate]
for 10 mm profiles

clear mat milky



1m	983010	983012	983014	7,95 €
2m	983011	983013	983015	17,95 €
3m	983016	983017	983018	25,95 €
4m	983060	983061	983062	33,95 €



1m	983510	983512	983514	7,95 €
2m	983511	983513	983515	17,95 €
3m	983516	983517	983518	25,95 €
4m	983560	983561	983562	33,95 €

end caps set | 2 pieces **4,95 €**
for 10 mm profiles

- white **978700**
- grey **978701**
- black **978702**



- grey **980541**

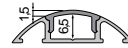

930105 310ml cartridge, white | glue+sealing power **35,95 €**



930348 3M double-sided tape | 50 m x 15 mm **26,95 €**



930650 screws set, incl. each 10 pieces
6 x 35 mm nylon dowels
4,5 x 45 mm stainless steel screw **7,95 €**



AV-03-12

corner-profile | 12 mm
for LED stripes up to 13,3 mm width



item	colour	dimensions L	price
970433	aluminium anodized	2m	37,95 €
970431	aluminium anodized	2,5m	46,95 €
970434	aluminium anodized	3m	59,95 €
970437	white	2m	37,95 €
970438	white	3m	59,95 €

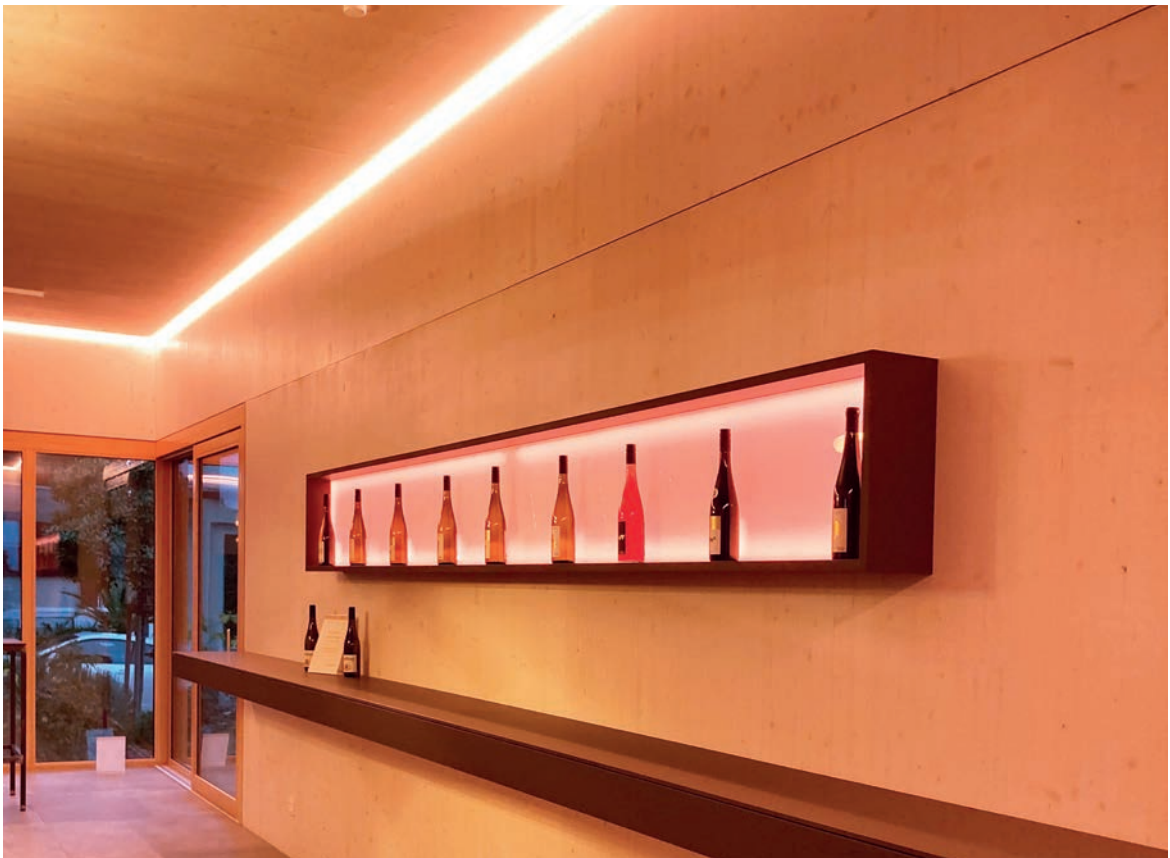
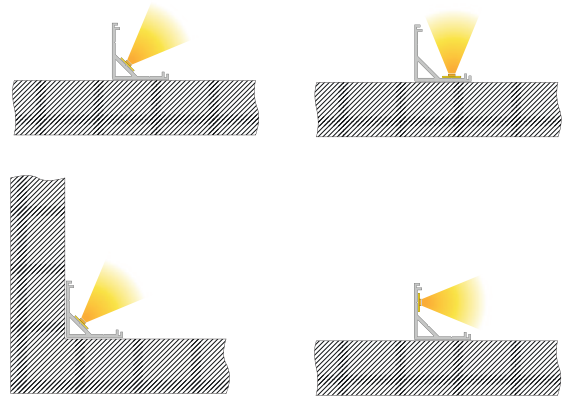
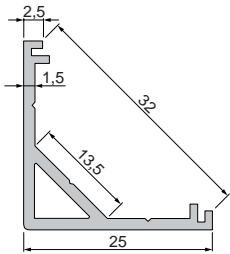

With the kind support of Elektro Grün, Neustadt an der Weinstraße

covers | PC [polycarbonate]
for 12 mm profiles

clear mat milky



2m
3m

984565 21,95 €
984568 32,95 €

end caps set | 2 pieces **4,95 €**
for 12 mm profiles

■ grey

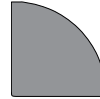

979751

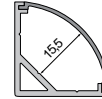

930105 310ml cartridge, white | glue+sealing power

35,95 €



930348 3M double-sided tape | 50 m x 15 mm

26,95 €

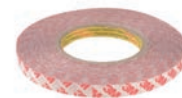

930650 screws set, incl. each 10 pieces
6 x 35 mm nylon dowels
4,5 x 45 mm stainless steel screw

7,95 €



AV-01-10

corner-profile | 10 mm
for LED stripes up to 11,3 mm width



item	colour	dimensions L	price
970401	aluminium anodized	2m	35,95 €
970404	aluminium anodized	3m	54,95 €
970403	white	2m	35,95 €



Foto: Daniel Wieser - Architekturfotografie, Karlsruhe

covers | PMMA [polymethylmethacrylat]
for 10 mm profiles

clear mat milky

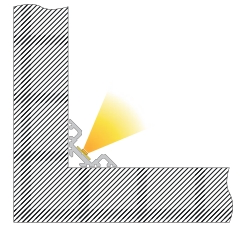
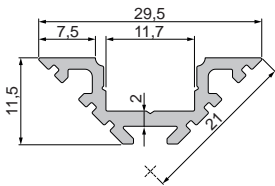

1m	983010	983012	983014	7,95 €
2m	983011	983013	983015	17,95 €
3m	983016	983017	983018	25,95 €
4m	983060	983061	983062	33,95 €



1m	983510	983512	983514	7,95 €
2m	983511	983513	983515	17,95 €
3m	983516	983517	983518	25,95 €
4m	983560	983561	983562	33,95 €



1m		984012	984014	7,95 €
2m		984013	984015	17,95 €
3m		984017	984018	25,95 €
4m		984010	984011	33,95 €



1m		984512	984514	7,95 €
2m		984513	984515	17,95 €
3m		984517	984518	25,95 €
4m		984510	984511	33,95 €



1m	985010			7,95 €
2m	985011			17,95 €
3m	985016			25,95 €

end caps set | 2 pieces **4,95 €**
for 10 mm profiles

white **978170**
 grey **978171**

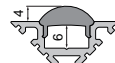
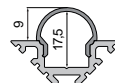
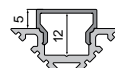
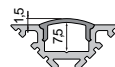

930105 310ml cartridge, white | glue+sealing power **35,95 €**



930348 3M double-sided tape | 50 m x 15 mm **26,95 €**



930650 screws set, incl. each 10 pieces
6 x 35 mm nylon dowels
4,5 x 45 mm stainless steel screw **7,95 €**



EV-04-12

corner-profile | 12 mm
for LED stripes up to 13,3 mm width

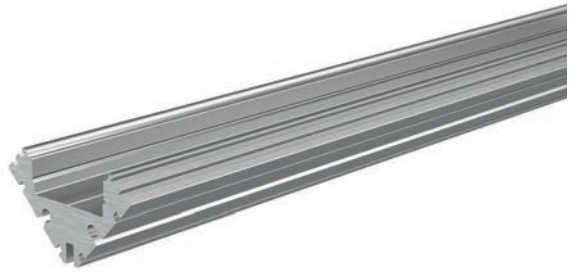

item	colour	dimensions L	price
975411	aluminium anodized	2m	39,95 €
975412	aluminium anodized	3m	61,95 €

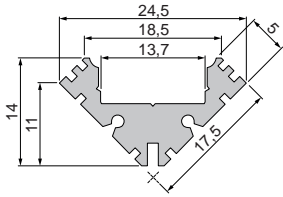

With the kind support of Elektro Grün, Neustadt an der Weinstraße

covers | PMMA [polymethylmethacrylat]
for 12 mm profiles

clear mat milky



1m	983020	983022	983024	7,95 €
2m	983021	983023	983025	17,95 €
3m	983028	983027	983026	25,95 €



1m	983520	983522	983524	7,95 €
2m	983521	983523	983525	17,95 €
3m	983527		983526	25,95 €



1m		984022	984024	7,95 €
2m		984023	984025	17,95 €
3m			984026	25,95 €



1m		984522	984524	7,95 €
2m		984523	984525	17,95 €
3m			984526	25,95 €

end caps set | 2 pieces **4,95 €**
for 12 mm profiles

grey

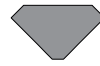

978341

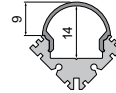
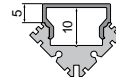
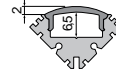
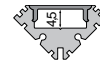

987006 fixation clamp 12 | set consisting of 2 pieces **3,95 €**



987080 universal mounting clip brackets [pivotable] set, 2 pieces | matching fixation clamp must be ordered separately **23,95 €**



930105 310ml cartridge, white | glue+sealing power **35,95 €**



930650 screws set, incl. each 10 pieces **7,95 €**
6 x 35 mm nylon dowels
4,5 x 45 mm stainless steel screw



AV-05-12

corner-profile | 12 mm
for LED stripes up to 12,5 mm width



item	colour	dimensions L	price
970550	aluminium anodized	2m	39,95 €
970551	aluminium anodized	3m	59,95 €

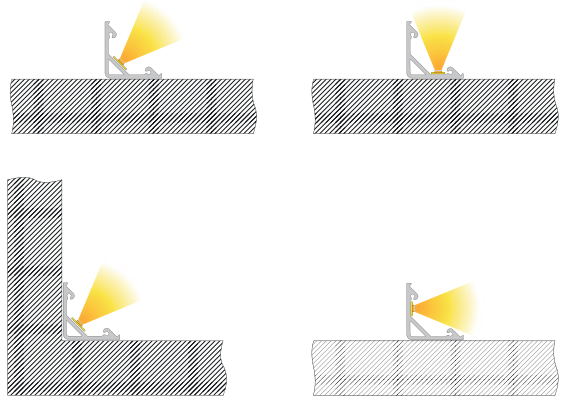
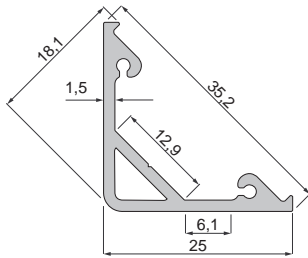

With the kind support of Alitherme Waldbrunn / Ziegler Technics buero@ziegler-technics.de

covers | PC [polycarbonate]
for 12 mm profiles

clear mat milky



2m
3m

983100 **23,95 €**
983101 **35,95 €**



2m
3m

984570 **23,95 €**
984571 **35,95 €**



2m
3m

985570 **23,95 €**
985571 **35,95 €**

end caps set | 2 pieces | aluminium **21,95 €**
for 12 mm profiles

■ silver

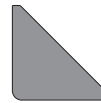

978370

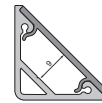

■ silver

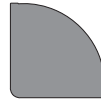

979760

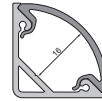

■ silver



980550

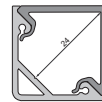

930105 310ml cartridge, white | glue+sealing power

35,95 €



930350 3M double-sided tape | 50 m x 25 mm

42,95 €

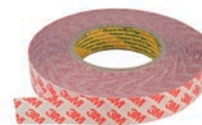

930650 screws set, incl. each 10 pieces
6 x 35 mm nylon dowels
4,5 x 45 mm stainless steel screw

7,95 €



AV-05-15

corner-profile | 15 mm
for LED stripes up to 15,4 mm width



item	colour	dimensions L	price
970560	aluminium anodized	2m	49,95 €
970561	aluminium anodized	3m	79,95 €

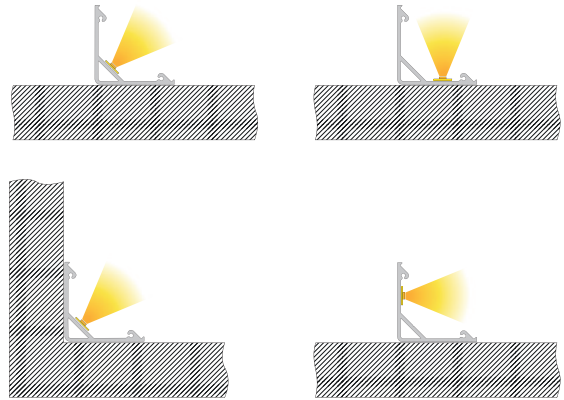
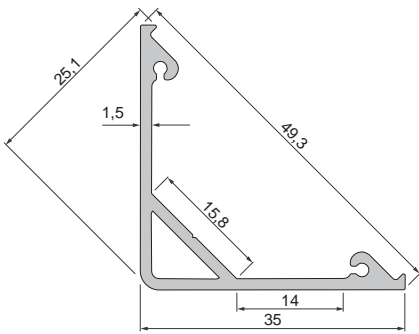

covers | PC [polycarbonate]
for 15 mm profiles

clear mat milky



2m

983110 **30,95 €**

3m

983111 **44,95 €**



2m

984580 **30,95 €**

3m

984581 **44,95 €**

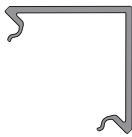

2m

985580 **30,95 €**

3m

985581 **44,95 €**

end caps set | 2 pieces | aluminium **21,95 €**
for 15 mm profiles

■ silver

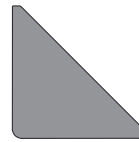

978380

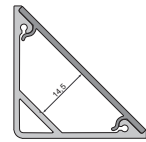

■ silver

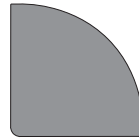

979770

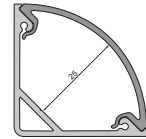

■ silver



980560

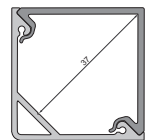

930105 310ml cartridge, white | glue+sealing power

35,95 €



930350 3M double-sided tape | 50 m x 25 mm

42,95 €

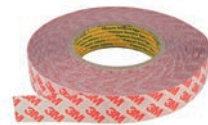

930650 screws set, incl. each 10 pieces
6 x 35 mm nylon dowels
4,5 x 45 mm stainless steel screw

7,95 €



AV-05-25

corner-profile | suitable for rope suspension | 25 mm
for LED stripes up to 25,5 mm width



item	colour	dimensions L	price
970570	aluminium anodized	2m	69,95 €
970571	aluminium anodized	3m	99,95 €

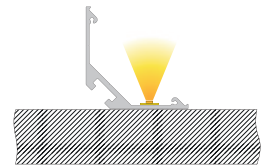
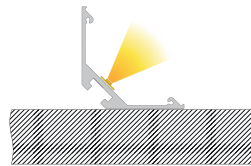
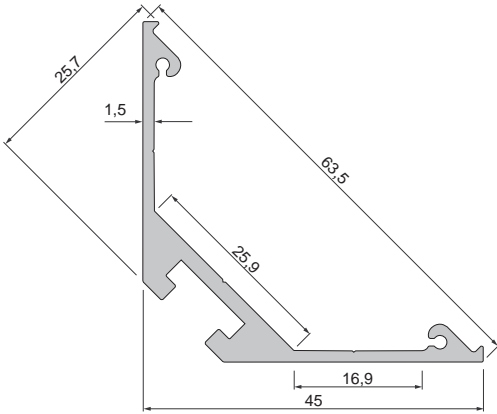

covers | PC [polycarbonate]
for 25 mm profiles

clear mat milky



2m **983120** **35,95 €**
3m **983121** **54,95 €**

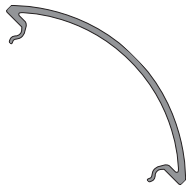

2m **984590** **35,95 €**
3m **984591** **54,95 €**

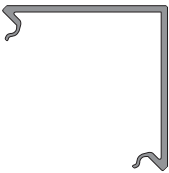

2m **985590** **35,95 €**
3m **985591** **54,95 €**

end caps set | 2 pieces | aluminium **21,95 €**
for 25 mm profiles

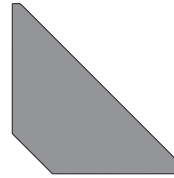

■ silver **978390**

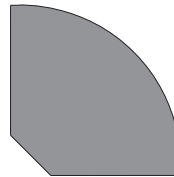
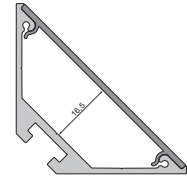

■ silver **979780**

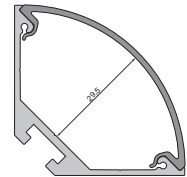

■ silver **980570**

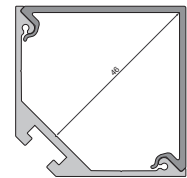

987060 wire suspension, pivotable, 2m | set | 2 pieces **35,95 €**
For the installation of the wire suspension you need, depending on the profile, the universal sliding block 987020.



987020 universal sliding block/straight connector set | 2 pieces **7,95 €**



930105 310ml cartridge, white | glue+sealing power **35,95 €**



930350 3M double-sided tape | 50 m x 25 mm **42,95 €**

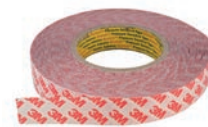

930650 screws set, incl. each 10 pieces **7,95 €**
6 x 35 mm nylon dowels
4,5 x 45 mm stainless steel screw





With the kind support of BEST Bellemann Elektro Service Team GmbH, Rauenberg-Malschenberg



dry construction profiles

Our dry construction profiles offer you full creative freedom. Redefine linear light – whether as a primary light or for accent lighting.

EL-02-12

dry construction profile for wall covering | 12 mm
for LED stripes up to 14 mm width



item	colour	dimensions L	price
975491	■ aluminium anodized	2m	82,95 €
975496	■ aluminium anodized	3m	124,95 €
975495	□ white	2m	82,95 €

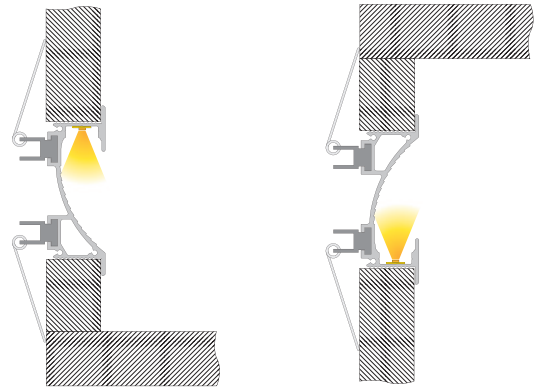
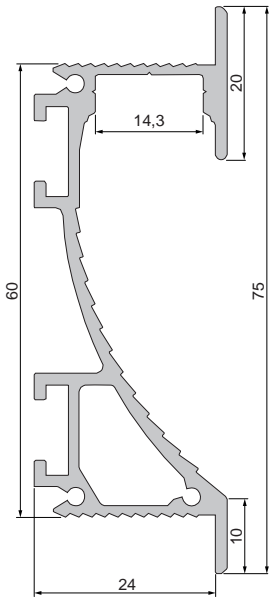

covers | PMMA [polymethylmethacrylat]
for 12 mm profiles

clear mat milky



1m	983020	983022	983024	7,95 €
2m	983021	983023	983025	17,95 €
3m	983028	983027	983026	25,95 €

end caps set | right + left **4,95 €**

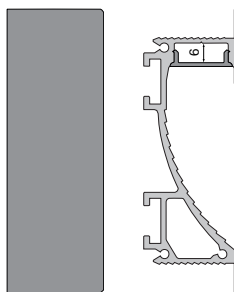

<input type="checkbox"/>	white	978250
<input checked="" type="checkbox"/>	grey	978251

end caps set | right + left | aluminium **35,95 €**



<input checked="" type="checkbox"/>	silver	978252
-------------------------------------	--------	---------------

930105 310ml cartridge, white | glue+sealing power **35,95 €**



987040 sliding block with springsset
set | 2 pieces **7,95 €**

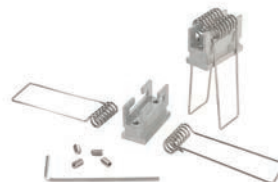

987020 universal sliding block/straight connector
set | 2 pieces **7,95 €**



ET-03-10

dry construction-built-in-T-profile | 10 mm
for LED stripes up to 12 mm width

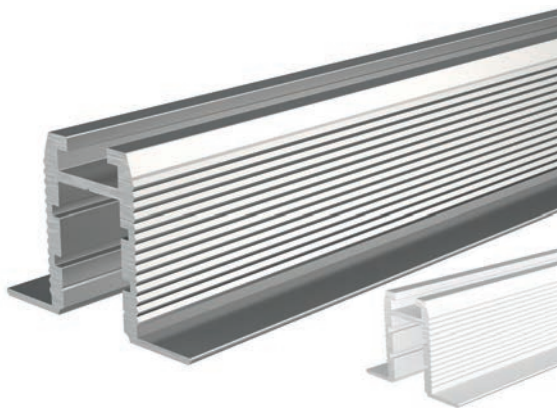

item	colour	dimensions L	price
975471	aluminium anodized	2,5m	59,95 €
975476	aluminium anodized	3m	75,95 €
975475	white	2,5m	59,95 €

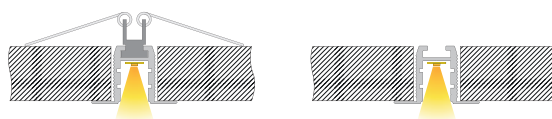
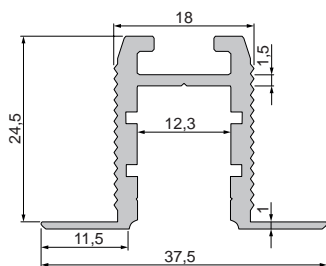

With the kind support of Friese Elektrotechnik, Ettenheim

covers | PMMA [polymethylmethacrylat]
for 10 mm profiles

clear mat milky



1m	983010	983012	983014	7,95 €
2m	983011	983013	983015	17,95 €
3m	983016	983017	983018	25,95 €
4m	983060	983061	983062	33,95 €



1m		984012	984014	7,95 €
2m		984013	984015	17,95 €
3m		984017	984018	25,95 €
4m		984010	984011	33,95 €



1m		984512	984514	7,95 €
2m		984513	984515	17,95 €
3m		984517	984518	25,95 €
4m		984510	984511	33,95 €

end caps set | 2 pieces **4,95 €**
for 10 mm profiles



□ white **978260**
■ grey **978261**

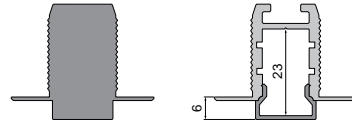

□ white **979200**
■ grey **979201**

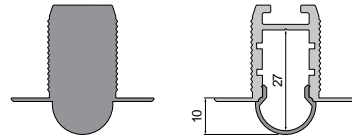

□ white **979700**
■ grey **979701**

970762 carrier profile for LED stripes
aluminium natural | 1,25m
to reduce the insertion depth of the LED stripe

7,95 €

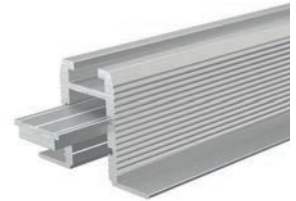
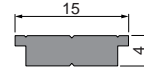

930105 310ml cartridge, white | glue+sealing power

35,95 €



987040 sliding block with springset
set | 2 pieces

7,95 €

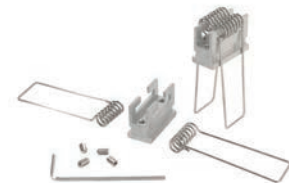

987020 universal sliding block/straight connector
set | 2 pieces

7,95 €



EL-03-10

dry construction profile for ceiling covers | 10 mm
for LED stripes up to 12 mm width

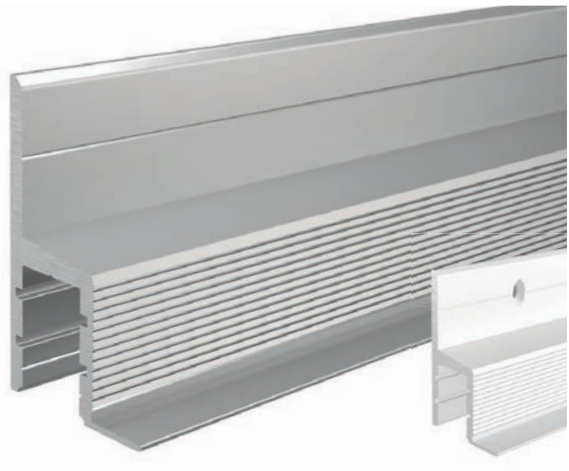

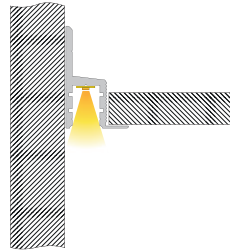
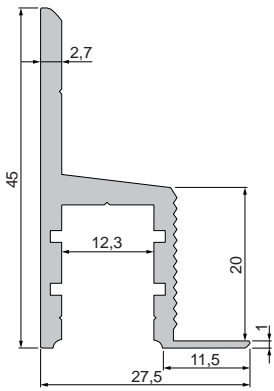

item	colour	dimensions L	price
975483	aluminium anodized	2m	59,95 €
975486	aluminium anodized	3m	94,95 €
975485	white	2,5m	79,95 €



covers | PMMA [polymethylmethacrylat]
for 10 mm profiles

clear mat milky



				
1m	983010	983012	983014	7,95 €
2m	983011	983013	983015	17,95 €
3m	983016	983017	983018	25,95 €
4m	983060	983061	983062	33,95 €

				
1m	984012	984014	984014	7,95 €
2m	984013	984015	984015	17,95 €
3m	984017	984018	984018	25,95 €
4m	984010	984011	984011	33,95 €

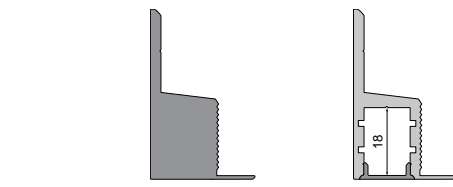

				
1m	984512	984514	984514	7,95 €
2m	984513	984515	984515	17,95 €
3m	984517	984518	984518	25,95 €
4m	984510	984511	984511	33,95 €

end caps set | right + left **4,95 €**



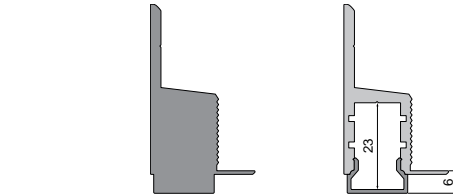

 white **978270**
 grey **978271**

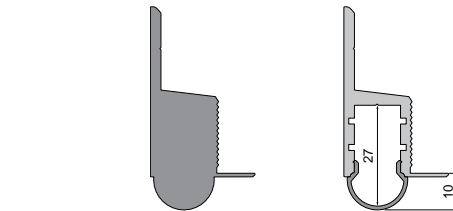

 white **979210**
 grey **979211**



 white **979710**
 grey **979711**

970762 carrier profile for LED stripes
aluminium natural | 1,25m
to reduce the insertion depth of the LED stripe

7,95 €

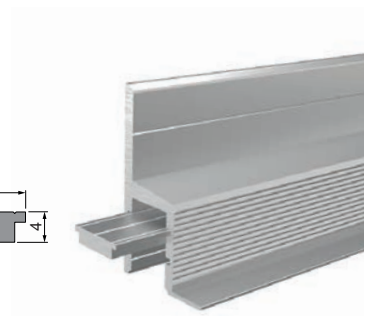
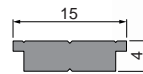

930650 screws set, incl. each 10 pieces
6 x 35 mm nylon dowels
4,5 x 45 mm stainless steel screw

7,95 €



EU-01-36

dry construction-built-in-U-profile | 35 mm
for LED stripes up to 36 mm width

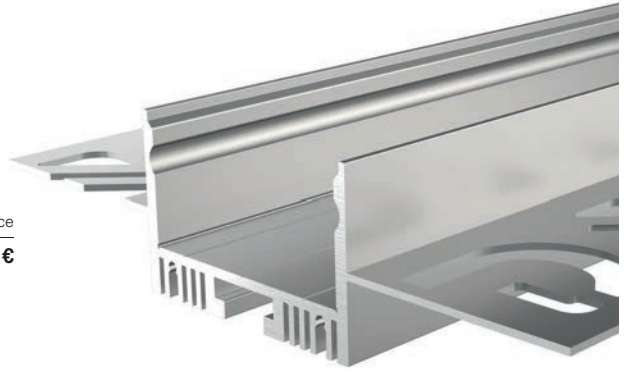

item	colour	dimensions L	price
975501	■ aluminium natural	3m	124,95 €

- optimised and designed for the built-in of 12.5 mm gypsum plasterboards
- easy to plaster thanks to optional inlay for protection
- increased passive cooling of the stripes due to cooling fins
- optimal for homogeneous bright light lines

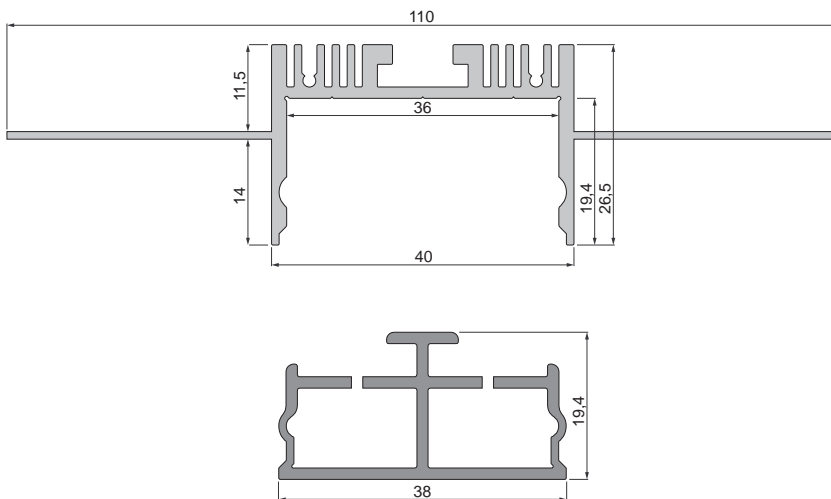
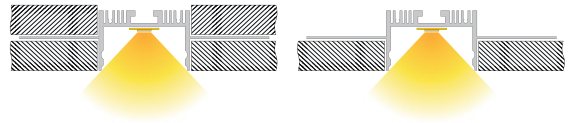

covers | PMMA [polymethylmethacrylat]
for 35 mm profiles

clear mat milky



3m

985601 42,95 €

end caps set | 2 pieces | aluminium **21,95 €**



■ silver

978175

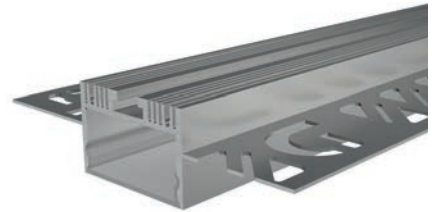
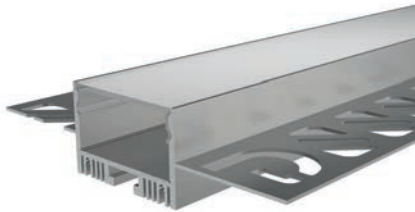
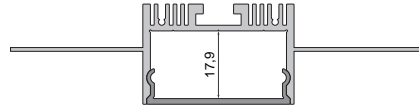

PROTECTION COVER

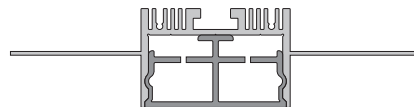
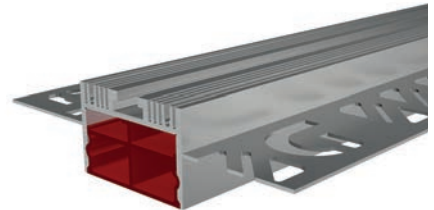
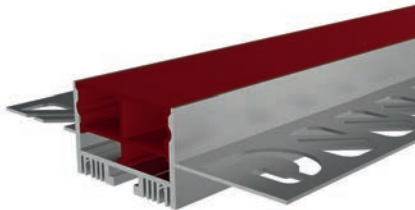

985605 inlay / dummy [reusable]
plastic | red | 3m
to protect against soiling during plastering

30,95 €



With the kind support of BEST Bellemann Elektro Service Team GmbH, Rauenberg-Malschenberg



tile profiles

Tile profiles play to every corner and closing area. Do away with conventional tile end profiles and set a new standard with linear light.

EL-01-08

tile profile | 8 mm
for LED stripes up to 9,3 mm width



item	colour	dimensions L	price
975331	aluminium anodized	2,5m	53,95 €
975334	aluminium anodized	3m	64,95 €

designed for tile thickness up to max. 9 mm

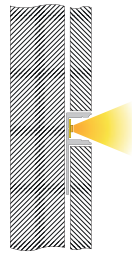
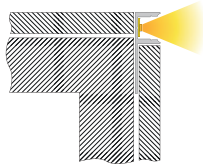
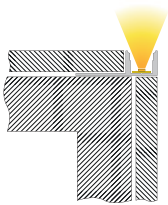
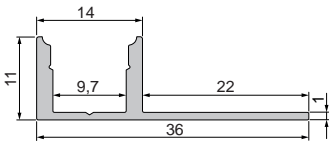

covers | PMMA [polymethylmethacrylat]
for 8 mm profiles

clear mat milky



1m	983000	983002	983004	7,95 €
2m	983001	983003	983005	17,95 €
3m	983006	983007	983008	25,95 €

end caps set | 2 pieces **4,95 €**
for 8 mm profiles



 grey **978211**



With the kind support of BEST Bellemann Elektro Service Team GmbH, Reuenberg-Malschenberg



EL-03-12

tile profile | 12 mm

for LED stripes up to 13,3 mm width



item	colour	dimensions L	price
975360	■ aluminium anodized	1,25m	28,95 €
975361	■ aluminium anodized	2,5m	59,95 €
975365	□ white	2,5m	59,95 €

designed for tile thickness up to max. 12 mm

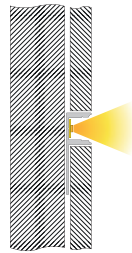
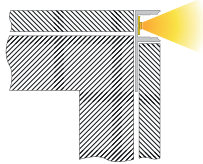
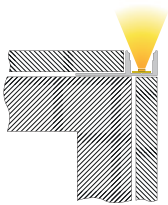
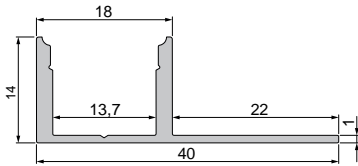

covers | PMMA [polymethylmethacrylat]
for 12 mm profiles

clear mat milky



1m	983020	983022	983024	7,95 €
2m	983021	983023	983025	17,95 €
3m	983028	983027	983026	25,95 €



1m		984022	984024	7,95 €
2m		984023	984025	17,95 €
3m			984026	25,95 €

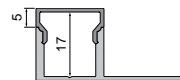

With the kind support of BEST Bellemann Elektro Service Team GmbH, Raunberg-Malschenberg



EA-03-12

tile-closing-profile | 12 mm
for LED stripes up to 13 mm width

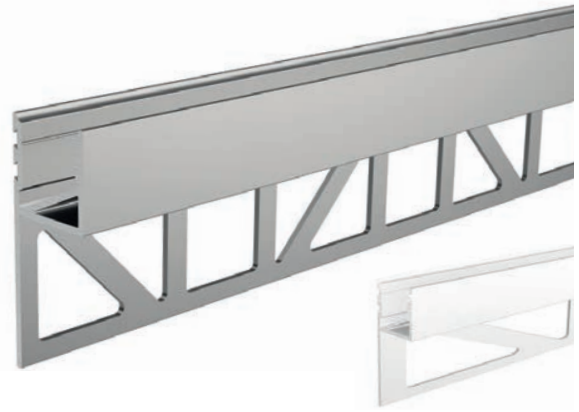

item	colour	dimensions L	price
975390	■ aluminium anodized	2m	38,95 €
975391	■ aluminium anodized	3m	59,95 €
975394	□ white	2m	38,95 €
975395	□ white	3m	59,95 €

designed for tile thickness up to max. 12 mm

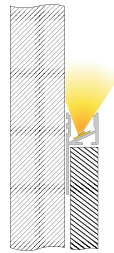
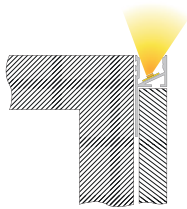
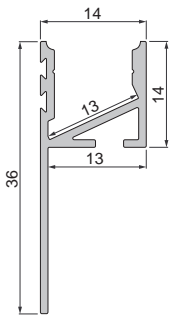

covers | PMMA [polymethylmethacrylat]
for 12 mm profiles

clear mat milky



1m	983000	983002	983004	7,95 €
2m	983001	983003	983005	17,95 €
3m	983006	983007	983008	25,95 €



1m		984002	984004	7,95 €
2m		984003	984005	17,95 €



EV-01-08

tile-inside-corner-profile | 8 mm
for LED stripes up to 9,3 mm width

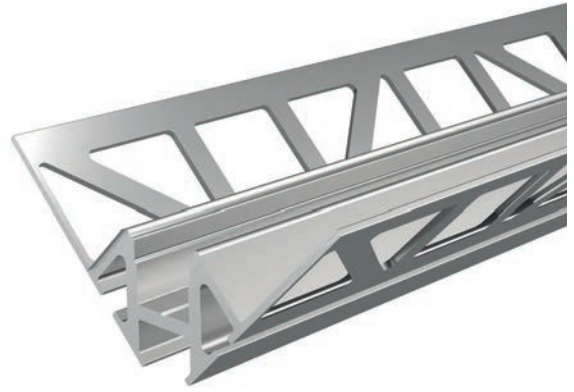

item	colour	dimensions L	price
975341	■ aluminium anodized	2,5m	79,95 €
975344	■ aluminium anodized	3m	99,95 €

designed for tile thickness up to max. 9 mm

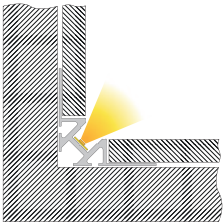
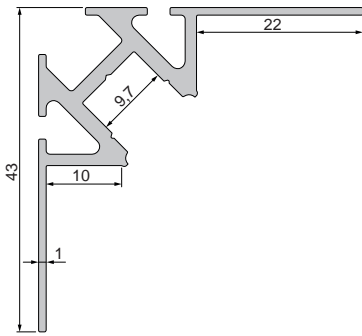

covers | PMMA [polymethylmethacrylat]
for 8 mm profiles

clear mat milky



1m	983000	983002	983004	7,95 €
2m	983001	983003	983005	17,95 €
3m	983006	983007	983008	25,95 €



1m		985504	7,95 €
2m		985505	17,95 €
3m		985508	25,95 €

end caps set | 2 pieces **4,95 €**
for 8 mm profiles

grey



978221

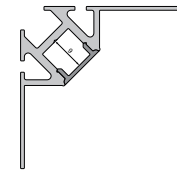

grey



980501

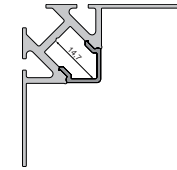

EV-01-12

tile-inside-corner-profile | 12 mm
for LED stripes up to 13,3 mm width

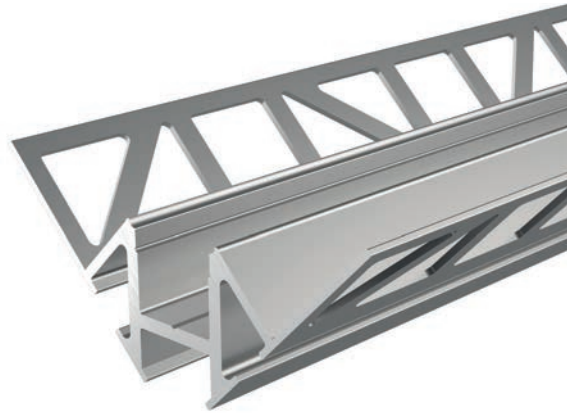

item	colour	dimensions L	price
975371	■ aluminium anodized	2,5m	99,95 €
975375	□ white	2,5m	99,95 €

designed for tile thickness up to max. 12 mm

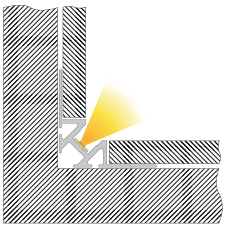
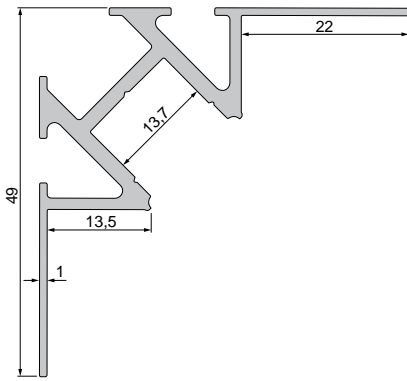

covers | PMMA [polymethylmethacrylat]
for 12 mm profiles

clear mat milky



1m	983020	983022	983024	7,95 €
2m	983021	983023	983025	17,95 €
3m	983028	983027	983026	25,95 €

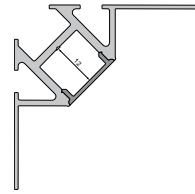

EV-02-08

tile-outside-corner-profile | 8 mm
for LED stripes up to 9,3 mm width



item	colour	dimensions L	price
975351	aluminium anodized	2,5m	79,95 €
975353	aluminium anodized	3m	99,95 €

designed for tile thickness up to max. 9 mm

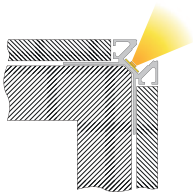
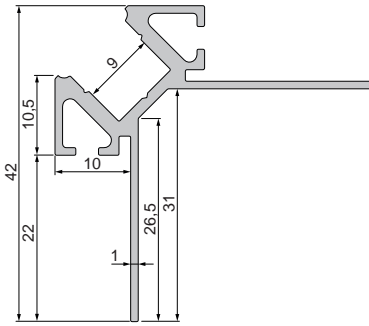

covers | PMMA [polymethylmethacrylat]
for 8 mm profiles

clear mat milky



1m	983000	983002	983004	7,95 €
2m	983001	983003	983005	17,95 €
3m	983006	983007	983008	25,95 €



1m		985504	7,95 €
2m		985505	17,95 €
3m		985508	25,95 €

end caps set | 2 pieces **4,95 €**
for 8 mm profiles

■ grey



978231

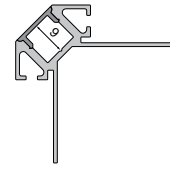

■ grey



980511

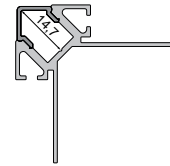

EV-02-12

tile-outside-corner-profile | 12 mm
for LED stripes up to 13,3 mm width

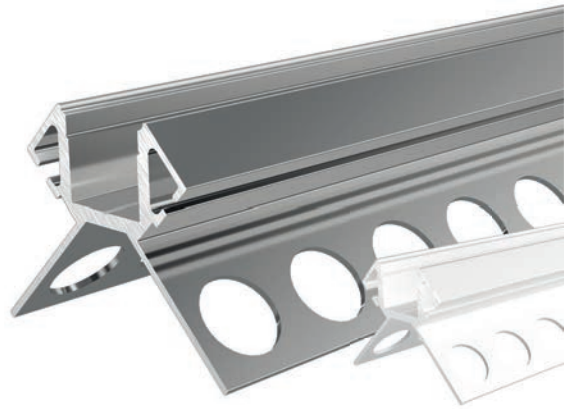

item	colour	dimensions L	price
975381	■ aluminium anodized	2,5m	99,95 €
975385	□ white	2,5m	99,95 €

designed for tile thickness up to max. 12 mm

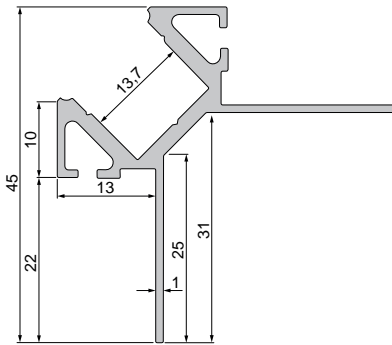

covers | PMMA [polymethylmethacrylat]
for 12 mm profiles

clear mat milky

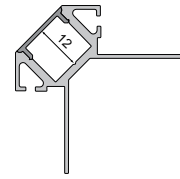

1m	983020	983022	983024	7,95 €
2m	983021	983023	983025	17,95 €
3m	983028	983027	983026	25,95 €





With the kind support of BEST Bellemann Elektro Service Team GmbH, Rauenberg-Malschenberg



profiles for outdoor use

Outdoor areas have different requirements than indoor areas. Our IP profiles are walkable and passable and inspire as a highlight in any outdoor design.

AU-04-12

IP-profile | walkable | 12 mm
for LED stripes up to 12,3 mm width



item	colour	dimensions L	price
970723	aluminium anodized	2m	23,95 €
970724	aluminium anodized	3m	35,95 €

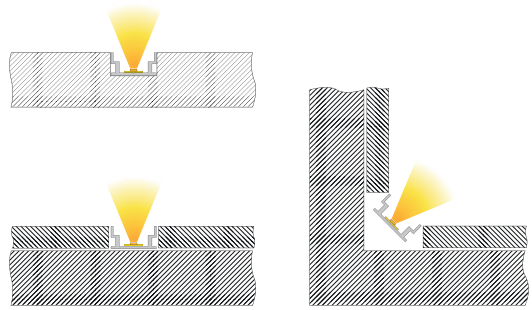
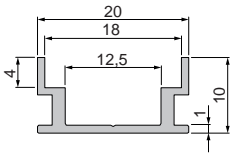

covers | Makrolon [polycarbonate]
 for 12 mm profiles
 walkable | material strength: 4mm
 optimum light diffusion | extremely impact resistant

end caps set | 2 pieces **4,95 €**
 for 12 mm profiles

clear mat milky



2m	988025	19,95 €
3m	988028	28,95 €

 grey



981001



! With professional processing, a protection class of up to IP65 can be achieved.

930104 natural stone sealant | 310ml cartridge
 transparent | for adhesion of cover **39,95 €**



930103 sealant smoothing agent | 400ml tin
 for clean stripping and to improve the surface of the sealant **39,95 €**



ET-05-12

IP-built-in-profile | walkable | 12 mm
for LED stripes up to 12,3 mm width

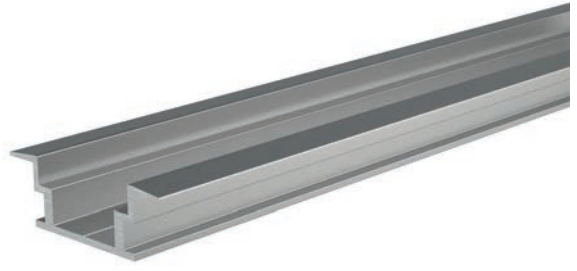

item	colour	dimensions L	price
975723	aluminium anodized	2m	23,95 €
975724	aluminium anodized	3m	35,95 €

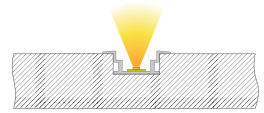
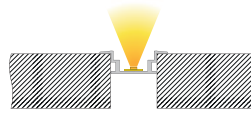
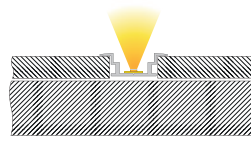
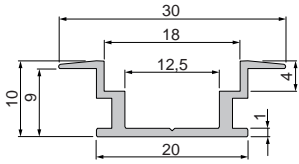

With the kind support of Oktec, Eisingen

covers | Makrolon [polycarbonate]
 for 12 mm profiles
 walkable | material strength: 4mm
 optimum light diffusion | extremely impact resistant

end caps set | 2 pieces **4,95 €**
 for 12 mm profiles

clear mat milky



2m	988025	19,95 €
3m	988028	28,95 €

 grey

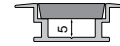

981011

! With professional processing, a protection class of up to IP65 can be achieved.

930104 natural stone sealant | 310ml cartridge
 transparent | for adhesion of cover

39,95 €



930103 sealant smoothing agent | 400ml tin
 for clean stripping and to improve the surface of the sealant

39,95 €



AU-05-15

IP-profile | walkable | 15 mm
for LED stripes up to 15,6 mm width



item	colour	dimensions L	price
970741	aluminium natural	2m	42,95 €

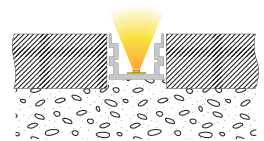
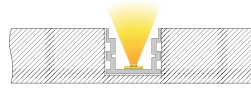
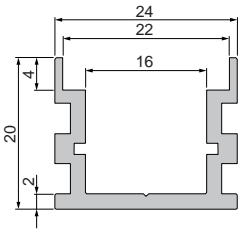

With the kind support of Elektro Grün, Neustadt an der Weinstraße

covers | Makrolon [polycarbonate]
 for 15 mm profiles
 walkable | material strength: 4mm
 optimum light diffusion | extremely impact resistant

clear mat milky



1m	988084	11,50 €
2m	988085	21,95 €

end caps set | 2 pieces **4,95 €**
 for 15 mm profiles

 grey



981031

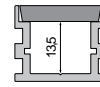

970764 carrier profile for LED stripes
 aluminium natural | 1m
 to reduce the insertion depth of the LED stripe

7,95 €

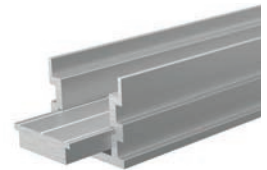

! With professional processing, a protection class of up to IP65 can be achieved.

930104 natural stone sealant | 310ml cartridge
 transparent | for adhesion of cover

39,95 €



930103 sealant smoothing agent | 400ml tin
 for clean stripping and to improve the surface of the sealant

39,95 €



ET-05-15

IP-built-in-T-profile | walkable | 15 mm
for LED stripes up to 15,6 mm width

item	colour	dimensions L	price
975741	aluminium natural	2m	42,95 €

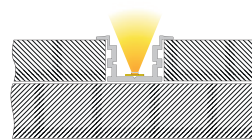
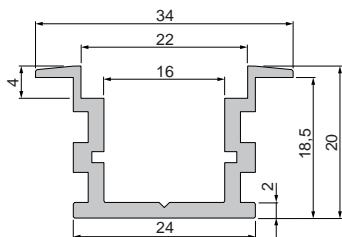
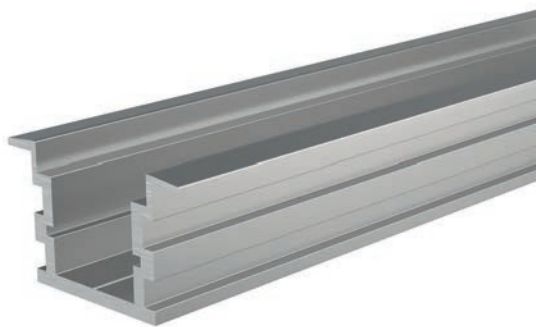

With the kind support of LED-TEC, Gira/Italien | Foto: fotoeichhorn

covers | Makrolon [polycarbonate]
 for 15 mm profiles
 walkable | material strength: 4mm
 optimum light diffusion | extremely impact resistant

clear mat milky



1m	988084	11,50 €
2m	988085	21,95 €

end caps set | 2 pieces **4,95 €**
 for 15 mm profiles

 grey

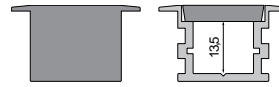

981041

970764 carrier profile for LED stripes
 aluminium natural | 1m
 to reduce the insertion depth of the LED stripe

7,95 €

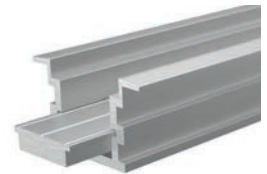
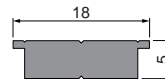

! With professional processing, a protection class of up to IP65 can be achieved.

930104 natural stone sealant | 310ml cartridge
 transparent | for adhesion of cover

39,95 €



930103 sealant smoothing agent | 400ml tin
 for clean stripping and to improve the surface of the sealant

39,95 €



EU-01-12

IP-built-in-profile | passable | 12 mm
for LED stripes up to 12 mm width

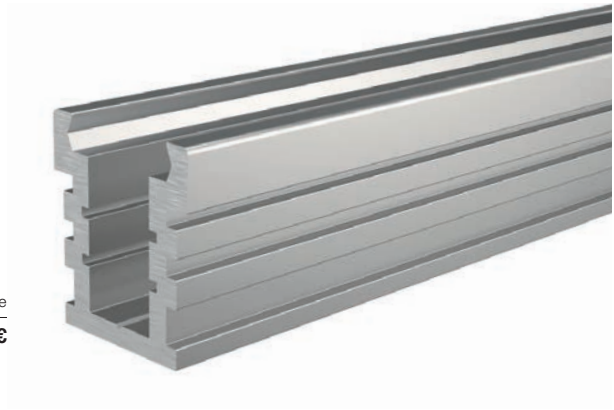

item	colour	dimensions L	price
975781	■ aluminium natural	2m	79,95 €

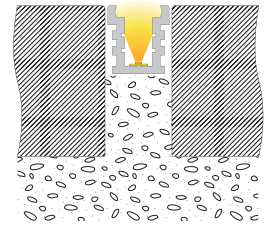
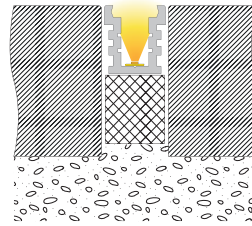
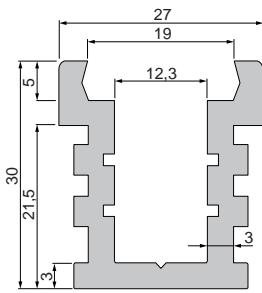

covers | Makrolon [polycarbonate]
 for 12 mm profiles
 passable | material strength: 5mm
 optimum light diffusion | extremely impact resistant

clear mat milky



1m	988054	11,50 €
2m	988055	21,95 €

end caps set | 2 pieces **4,95 €**
 for 12 mm profiles

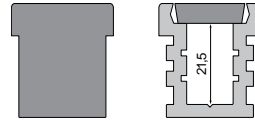

 grey **981021**

970762 carrier profile for LED stripes
 aluminium natural | 1,25m
 to reduce the insertion depth of the LED stripe

7,95 €

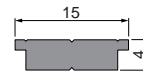

990109 foam support | 123,5 x 3,3 x 3 cm
 plastic | hard foam
 for relining the profile

7,95 €



! With professional processing, a protection class of up to IP65 can be achieved.
 Can be driven over with a maximum load of 1 tonne. We recommend our matching foam underlay.

930104 natural stone sealant | 310ml cartridge
 transparent | for adhesion of cover

39,95 €



930103 sealant smoothing agent | 400ml tin
 for clean stripping and to improve the surface of the sealant

39,95 €





LED STRIPES

- 630 LED stripes | overview
- 632 technical information
- 634 quick finder
- 638 COB | 1CH / 2CH / 3CH | 24V
- 646 standard | 1CH | 12V / 24V / 48V
- 656 standard | 2CH | 12V / 24V
- 662 standard | 3CH | 24V
- 666 standard | 4CH | 24V
- 670 D FLEX LINE top-view | 1CH / 3CH / 4CH | 24V
- 678 D FLEX LINE side-view | 1CH / 4CH | 24V
- 684 230V | 1CH



WW NW

COB stripes

1CH | 24V

from page 638



WW CW

COB stripes

2CH | 24V

from page 642



RGB

COB stripes

3CH | 24V

from page 644



WW NW CW

standard stripes

1CH | 12V

from page 646



WW NW CW

standard stripes

1CH | 24V

from page 648



WW NW

standard stripes

1CH | 48V

from page 654



WW CW

standard stripes

2CH | 12V

from page 656



WW CW

standard stripes

2CH | 24V

from page 658



RGB

standard stripes

3CH | 24V

from page 662



RGB WW NW

standard stripes

4CH | 24V

from page 666



ww

D FLEX LINE TOP-VIEW
1CH | 24V
from page 671



RGB

D FLEX LINE TOP-VIEW
3CH | 24V
page 675



RGB ww

D FLEX LINE TOP-VIEW
4CH | 24V
page 677



ww

D FLEX LINE SIDE-VIEW
1CH | 24V
from page 679



RGB ww

D FLEX LINE SIDE-VIEW
4CH | 24V
page 683



ww nw

230V stripes
1CH
page 685

LED stripes

THINGS TO KNOW ABOUT LED STRIPES

Which LED chips and sizes are most commonly installed in our company?

On these two pages, we focus on LED stripes, or more precisely on the LED chips installed on them. These are installed in a wide variety of sizes, power classes, quantities and distances for a wide variety of stripes in 12V, 24V, 48V and 230V.

quality promise

Our LED stripes are subjected to constant quality control during production. Thus, we can guarantee the high quality of our LED stripes.

STRUCTURE OF A STANDARD LED CHIP

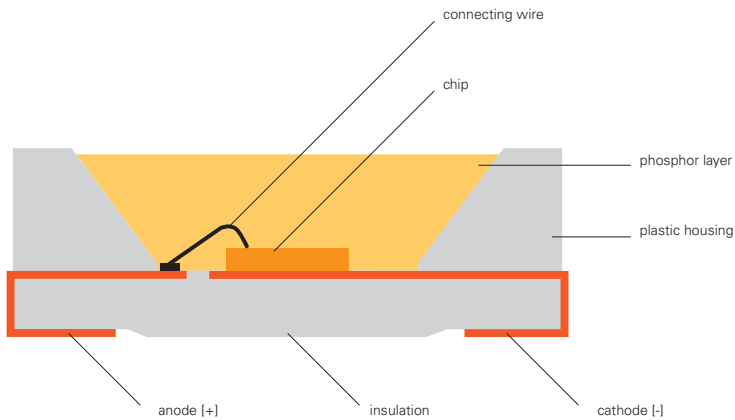

WHAT DO THE NUMBERS MEAN FOR A LED STRIPE?

The numbers clearly indicate the size [width and length] and shape of the LED chips installed on a carrier [stripe]. For example, the LED chip 5050 – one of the world's most

frequently used LED chips – has a width of LED chips – each with a length and width of 5 mm. A 2835 LED chip therefore has a width of 2.8 mm and a length of 3.5 mm.

SMD 5050 | single
chip dimensions: 5 x 5 mm

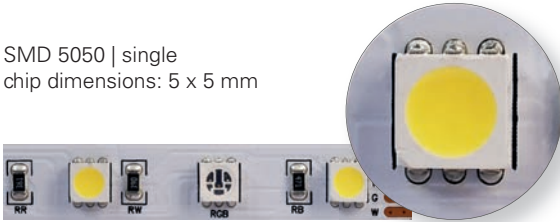

SMD 2835 | single
chip dimensions: 2,8 x 3,5 mm

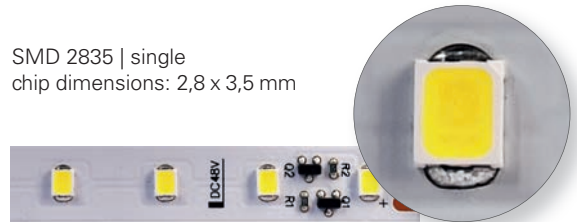

SMD 5050 | RGB
chip dimensions: 5 x 5 mm

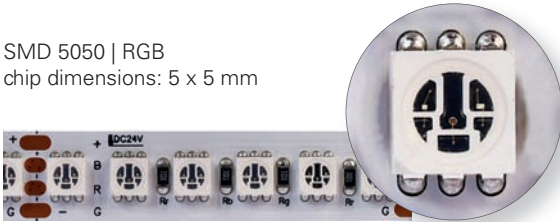

SMD 2835 | WW / CW
chip dimensions: 2,8 x 3,5 mm



SMD 5050 | WW / CW
chip dimensions: 5 x 5 mm



SMD 2216 | single
chip dimensions: 1,6 x 2,2 mm

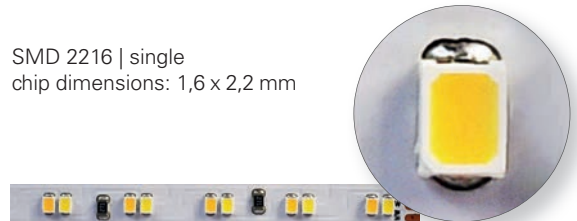

SMD 3528 | single
chip dimensions: 2,8 x 3,5 mm

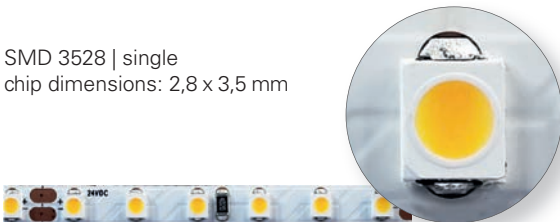

SMD 1808 | single
chip dimensions: 0,8 x 1,8 mm

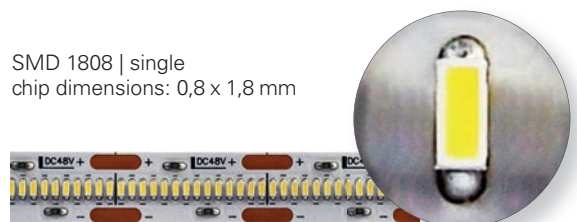



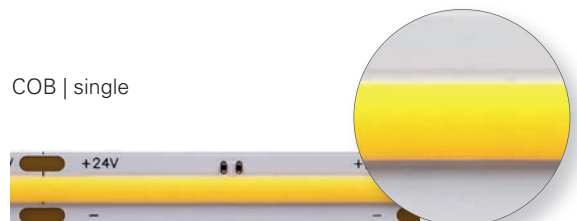















COB | single



width in mm	voltage [DC]	W / m	type	light colour	colour temperature	lm / m	LED / m	length in mm	protection class	item number	page
4,0	24V	11,0	standard	ww	2700K	995	266	5000	IP20	840175	650
4,0	24V	11,0	standard	ww	3000K	1090	266	5000	IP20	840210	650
4,0	24V	11,5	standard	nw	4000K	1100	266	5000	IP20	840267	650
5,0	24V	8,5	standard	ww	2700K	680	120	5000	IP20	840158	649
5,0	24V	10,5	standard	ww	3000K	730	120	5000	IP20	840159	649
5,0	24V	11,0	standard	RGB		500	120	5000	IP20	840276	663
6,5	24V	9,5	D FLEX side view	ww	3000K	287	120	5000	IP44	840376	679
7,0	24V	8,0	D FLEX side view	ww	3000K	295	120	5000	IP68	840283	680
7,0	24V	12,5	standard	ww cw	3000-6500K	1070	196	5000	IP67	840349	660
8,0	12V	6,5	standard	ww	3000K	555	120	5000	IP20	840165	647
8,0	12V	7,0	standard	ww	2700K	570	120	5000	IP20	840164	647
8,0	12V	7,0	standard	cw	6500K	630	120	5000	IP20	840167	647
8,0	12V	7,0	standard	nw	4000K	670	120	5000	IP20	840166	647
8,0	12V	10,0	standard	ww cw	3000-6500K	760	120	5000	IP20	840097	657
8,0	24V	11,0	standard	ww cw	3000-6500K	1025	196	5000	IP20	840350	659
8,0	24V	13,5	standard	ww	3000K	1100	180	5000	IP20	840179	650
8,0	24V	13,5	standard	ww	3000K	1100	180	50000	IP20	930512	650
8,0	24V	13,5	standard	nw	4000K	1220	180	5000	IP20	840180	650
8,0	24V	13,5	standard	nw	4000K	1225	180	50000	IP20	930513	650
8,0	24V	14,0	standard	ww	2700K	1110	180	5000	IP20	840178	650
9,5	24V	10,0	D FLEX top view	RGB		315	120	5000	IP68	840286	675
9,5	24V	10,5	D FLEX top view	ww	3000K	730	144	5000	IP68	840285	671
10,0	24V	17,2	standard	ww cw	2700-6500K	1765	140	5000	IP20	840378	659
10,0	24V	14,0	standard	ww cw	2700-6500K	1470	140	5000	IP44	840379	660
10,0	48V	4,0	standard	ww	3000K	400	78	15000	IP44	840317	655
10,0	48V	4,0	standard	ww	3000K	405	78	50000	IP44	840338	655
10,0	48V	4,0	standard	nw	4000K	455	78	15000	IP44	840319	655
10,0	48V	4,0	standard	nw	4000K	455	78	50000	IP44	840340	655

width in mm	voltage [DC]	W / m	type	light colour	colour temperature	lm / m	LED / m	length in mm	protection class	item number	page
10,0	48V	4,0	standard	ww	3000K	485	78	15000	IP20	840318	655
10,0	48V	4,0	standard	ww	3000K	485	78	50000	IP20	840337	655
10,0	48V	4,0	standard	nw	4000K	530	78	15000	IP20	840320	655
10,0	48V	4,0	standard	nw	4000K	530	78	50000	IP20	840339	655
10,0	24V	9,5	standard	ww	3000K	705	120	10000	IP20	840291	649
10,0	24V	10,5	COB	ww cw	2700-6500K	960	576	5000	IP20	840374	643
10,0	12V	10,5	standard	ww cw	3000-6500K	1025	120	5000	IP20	840142	657
10,0	24V	12,0	COB	nw	4000K	1130	480	5000	IP20	840304	639
10,0	24V	12,5	COB	ww	3000K	1120	480	5000	IP20	840296	639
10,0	24V	13,0	standard	rgb		580	60	5000	IP20	840254	663
10,0	24V	14,0	standard	rgb		665	96	5000	IP20	840147	664
10,0	24V	14,5	standard	rgb		665	96	50000	IP20	930516	664
10,0	24V	16,0	COB	ww	3000K	2230	480	5000	IP20	840323	639
10,0	24V	16,0	COB	nw	4000K	2565	480	5000	IP20	840324	639
10,0	24V	16,0	standard	rgb ww	3000K	820	60	5000	IP20	840236	667
10,0	24V	16,0	standard	rgb ww	3000K	820	60	50000	IP20	930517	667
10,0	24V	16,5	standard	rgb nw	4000K	775	60	5000	IP20	840353	668
10,0	24V	16,5	COB	rgb		660	840	5000	IP20	840375	645
10,0	24V	16,0	standard	rgb nw	4000K	765	60	5000	IP44	840373	669
10,0	24V	18,5	standard	ww	2700K	1215	240	5000	IP20	840192	651
10,0	24V	19,0	standard	ww	3000K	1605	240	5000	IP20	840193	651
10,0	24V	19,0	standard	ww	3000K	1605	240	50000	IP20	930514	651
10,0	24V	20,0	standard	nw	4000K	1770	240	5000	IP20	840194	651
10,0	24V	20,0	standard	nw	4000K	1770	240	50000	IP20	930515	651
10,0	24V	20,0	standard	cw	6000K	1720	120	5000	IP20	840124	652
10,0	24V	21,0	standard	ww	3000K	1595	120	5000	IP20	840122	652
10,0	24V	22,5	standard	ww	3000K	2520	160	5000	IP44	840333	653
10,0	24V	22,5	standard	nw	4000K	2555	160	5000	IP44	840334	653

width in mm	voltage [DC]	W / m	type	light colour	colour temperature	lm / m	LED / m	length in mm	protection class	item number	page
10,0	24V	22,5	standard		4000K	2815	160	5000	IP20	840332	652
10,0	24V	22,5	standard		3000K	2570	160	5000	IP20	840331	652
10,5	12V	7,0	standard		2700K	550	120	5000	IP67	840172	647
10,5	24V	11,5	standard		2700K	900	180	5000	IP67	840186	653
10,5	24V	11,0	standard		3000K	930	180	5000	IP67	840187	653
12,0	24V	10,5	D FLEX side view		3000K	368	144	5000	IP68	840287	681
12,0	24V	10,5	D FLEX side view		3200K	210	84	5000	IP68	840290	683
12,0	24V	14,0	standard		3000K	585	96	5000	IP20	840144	667
12,0	24V	22,0	standard		3000K	955	192	5000	IP20	840308	668
12,0	24V	22,0	standard		4000K	985	192	5000	IP20	840309	668
12,0	24V	27,5	standard			1045	120	5000	IP44	840351	665
12,0	24V	28,0	standard			1055	120	5000	IP20	840352	664
12,5	24V	12,5	standard			530	60	5000	IP67	840256	665
12,5	24V	15,0	COB		3000K	2225	480	5000	IP67	840321	640
12,5	24V	15,0	COB		4000K	2455	480	5000	IP67	840322	640
12,5	24V	15,0	standard		3000K	735	60	5000	IP67	840239	669
16,0	24V	10,5	D FLEX top view		3200K	320	84	5000	IP68	840289	677
16,5	24V	10,5	D FLEX top view		3000K	515	144	5000	IP68	840288	673
17,2	230V	14,0			2700K	1442	84	15000	IP65	840390	685
17,2	230V	14,0			2700K	1442	84	50000	IP65	840391	685
17,2	230V	14,0			3000K	1470	84	15000	IP65	840386	685
17,2	230V	14,0			3000K	1470	84	50000	IP65	840387	685
17,2	230V	14,0			4000K	1596	84	15000	IP65	840388	685
17,2	230V	14,0			4000K	1596	84	50000	IP65	840389	685

quick finder sorted in ascending order by width and performance



COB | 1CH | 24V

COB stripes in warm white 3000K und neutral white 4000K
These LED stripes are ideal when the focus is on a homogeneous light pattern.



COB-480-24V-3000K / 4000K-5M

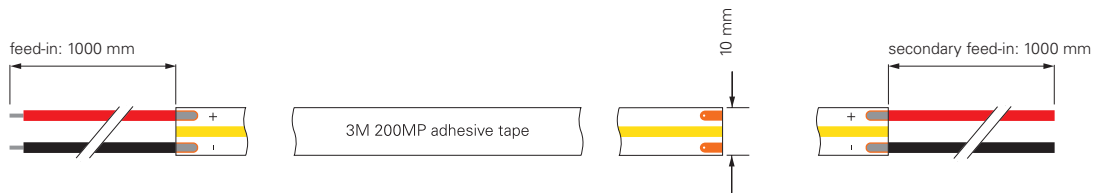
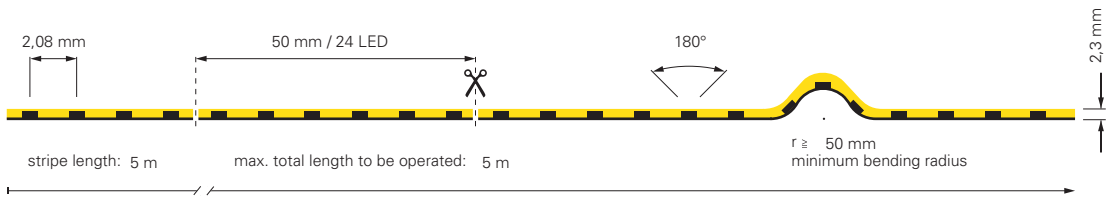

item	colour temperature	efficiency	light current	dimensions L	power	light source	price
840296	WW 3000K	90 lm/W	1120 lm/m	5000 mm	12,5 W/m	480 LED/m	179,95 €
840304	NW 4000K	94 lm/W	1130 lm/m	5000 mm	12,0 W/m	480 LED/m	179,95 €



COB-480-24V-3000K / 4000K-5M

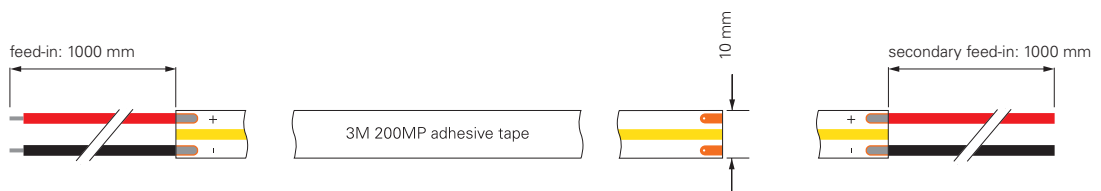
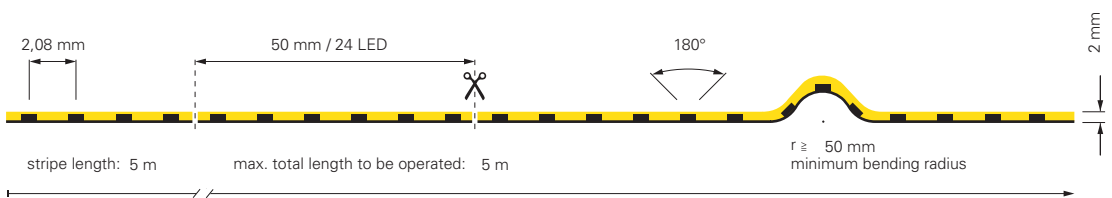

item	colour temperature	efficiency	light current	dimensions L	power	light source	price
840323	WW 3000K	139 lm/W	2230 lm/m	5000 mm	16 W/m	480 LED/m	199,95 €
840324	NW 4000K	160 lm/W	2565 lm/m	5000 mm	16 W/m	480 LED/m	199,95 €



COB-480-24V-3000K / 4000K-5M-SILIKON

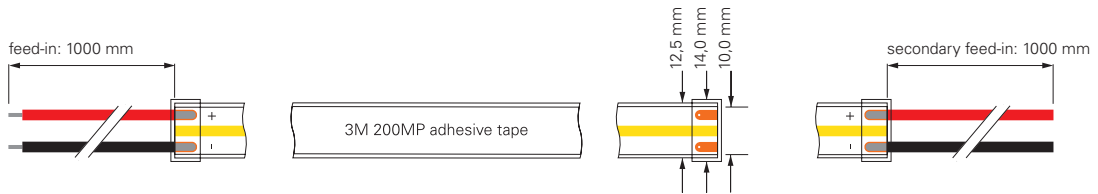
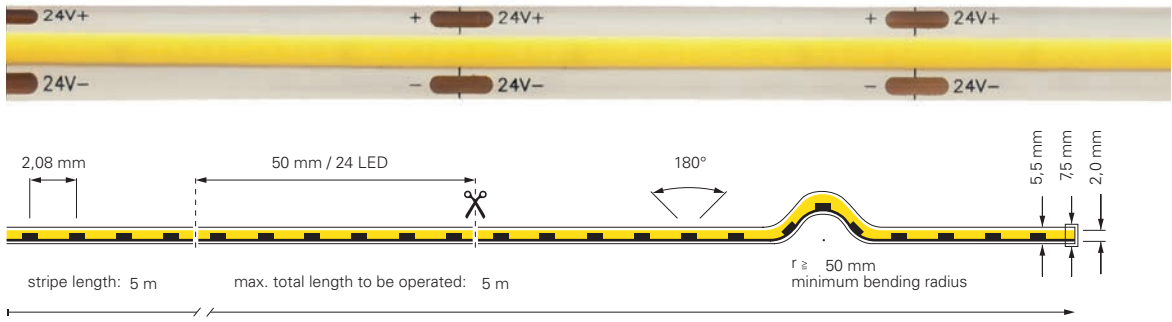

item	colour	temperature	efficiency	light current	dimensions L	power	light source	price
840321	ww	3000K	148 lm/W	2225 lm/m	5000 mm	15 W/m	480 LED/m	229,95 €
840322	nw	4000K	164 lm/W	2455 lm/m	5000 mm	15 W/m	480 LED/m	229,95 €



incl. accessories: 10x retaining bracket, 20x stainless steel screw, 2x endcap



COB | 2CH | 24V

COB stripe in warm white 2700K – cold white 6500K
These LED stripes are ideal when the focus is on a homogeneous light pattern. With these COB stripes, you have the option of mixing white tones between 2700K and 6500K through flexible control.





COB-576-24V-2700-6500K-5M

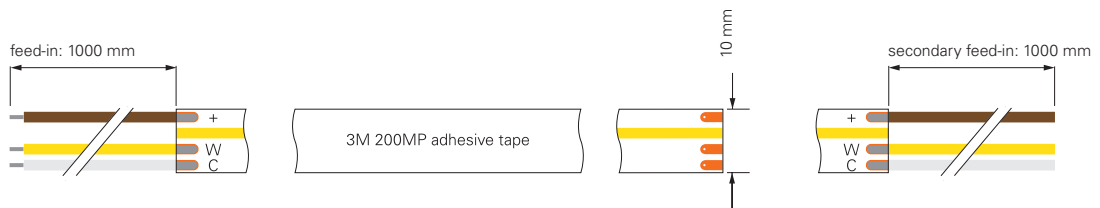
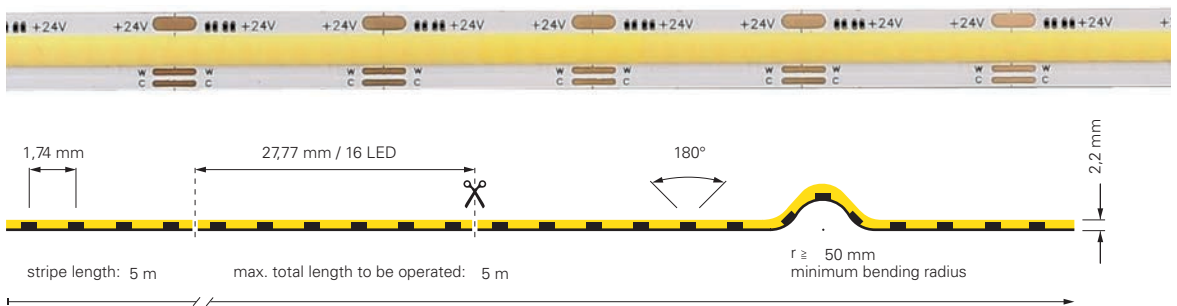

item	colour temperature	efficiency	light current	dimensions L	power	light source	price
840374	WW CW 2700-6500K	91 lm/W	960 lm/m	5000 mm	10,5 W/m	576 LED/m	339,95 €

CV	24 Volt	COB	Ra 90		IP20	-15°C +50°C
----	---------	-----	-------	--	------	----------------

COB | 3CH | 24V

COB stripe in RGB

These LED stripes are ideal when the focus is on a homogeneous light pattern. With these COB stripes, you have the option of setting individual colours or mixed colours as desired through flexible control.



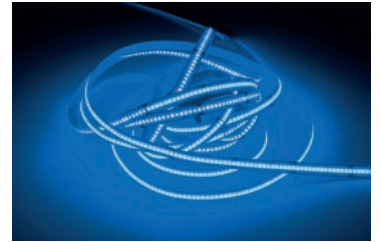
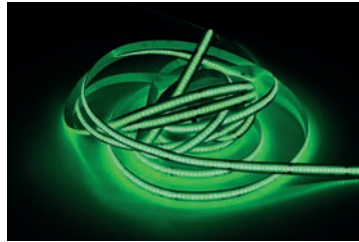
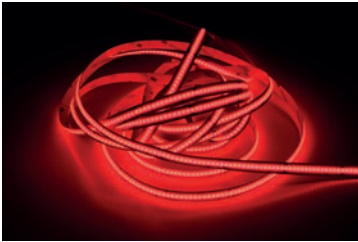

COB-840-24V-RGB-5M

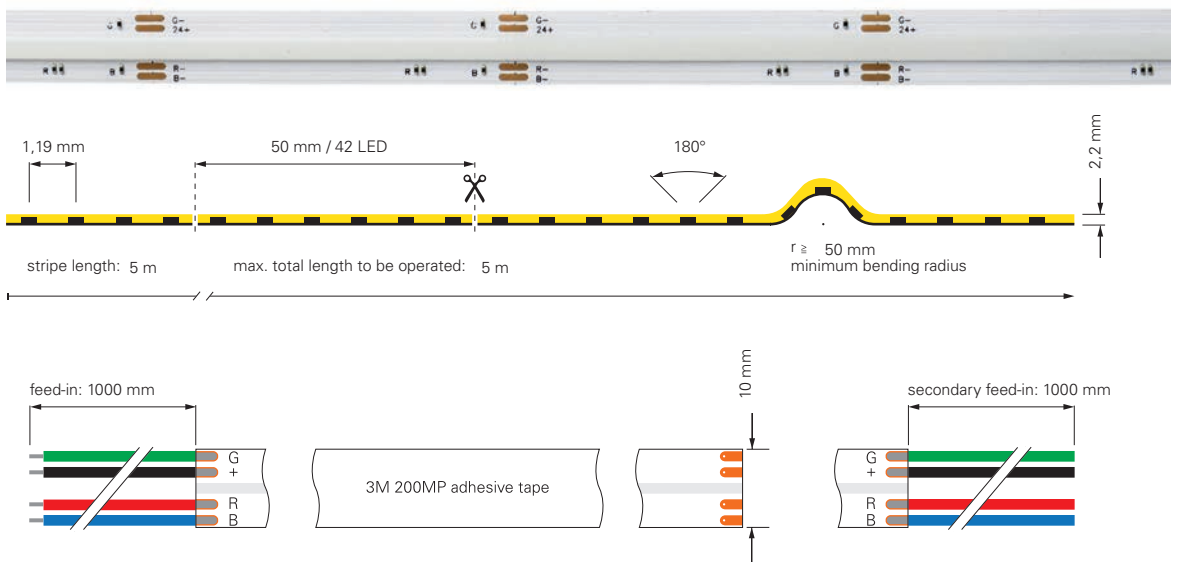

item	colour temperature	efficiency	light current	dimensions L	power	light source	price
840375	RGB 460-620 nm	40 lm/W	660 lm/m	5000 mm	16,5 W/m	840 LED/m	449,95 €

CV	24 Volt	COB	+ -	3 CH	IP20	-15°C +50°C
----	---------	-----	-----	------	------	----------------

STANDARD | 1CH | 12V

LED stripes in warm white 2700K + 3000K, neutral white 4000K and cold white 6500K
These LED stripes are ideally suited for all standard applications and special assemblies with the most diverse requirements. With voltages of 12V, different protection classes, lumens, number of LEDs, power and much more, you will find the right LED stripe for your application.



3528-120-12V-2700K / 3000K / 4000K / 6500K-5M

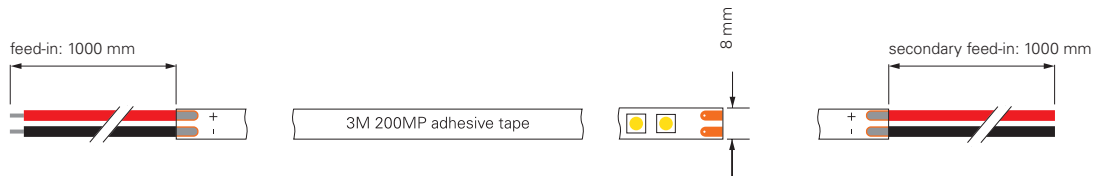
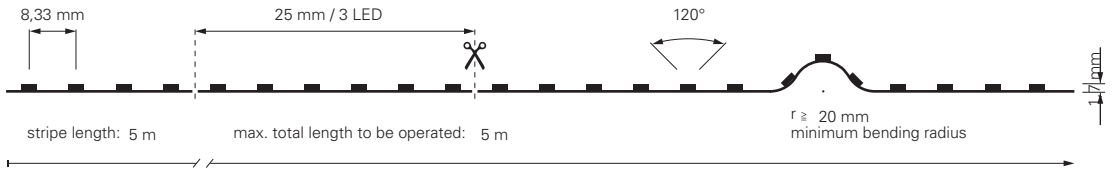

item	colour temperature	efficiency	light current	dimensions L	power	light source	price
840164	ww 2700K	81 lm/W	570 lm/m	5000 mm	7,0 W/m	120 LED/m	99,95 €
840165	ww 3000K	85 lm/W	555 lm/m	5000 mm	6,5 W/m	120 LED/m	99,95 €
840166	nw 4000K	96 lm/W	670 lm/m	5000 mm	7,0 W/m	120 LED/m	99,95 €
840167	cw 6500K	90 lm/W	630 lm/m	5000 mm	7,0 W/m	120 LED/m	99,95 €



3528-120-12V-2700K-5M-SILIKON

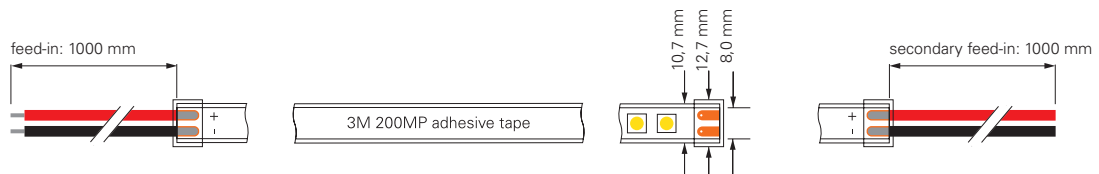
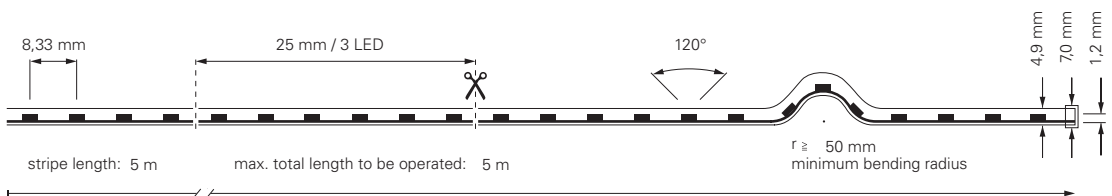

item	colour temperature	efficiency	light current	dimensions L	power	light source	price
840172	ww 2700K	79 lm/W	550 lm/m	5000 mm	7 W/m	120 LED/m	159,95 €



incl. accessories: 10x retaining bracket, 20x stainless steel screw, 2x endcap

STANDARD | 1CH | 24V

LED stripes in warm white 2700K + 3000K, neutral white 4000K and cold white 6500K
These LED stripes are ideally suited for all standard applications and special assemblies with the most diverse requirements. With voltages of 24V, different protection classes, lumens, number of LEDs, power and much more, you will find the right LED stripe for your application.



3528-120-24V-2700K / 3000K-5M

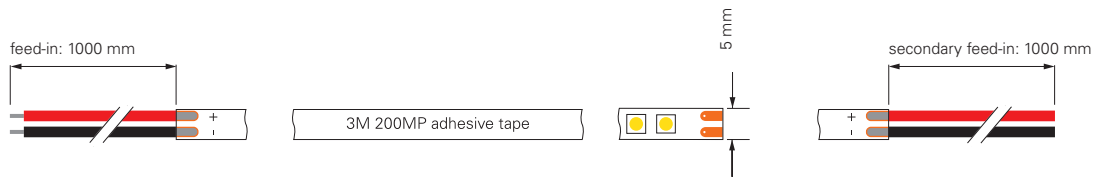
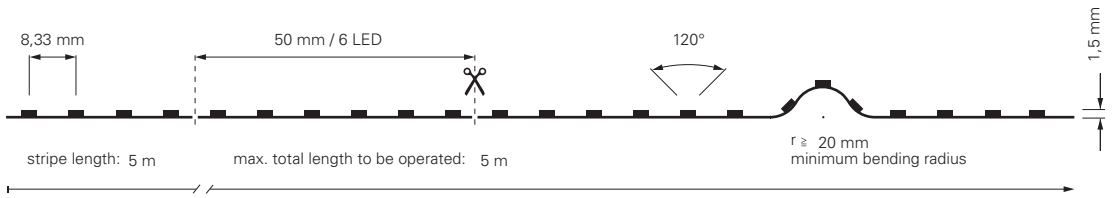

item	colour temperature	efficiency	light current	dimensions L	power	light source	price
840158	ww 2700K	80 lm/W	680 lm/m	5000 mm	8,5 W/m	120 LED/m	89,95 €
840159	ww 3000K	70 lm/W	730 lm/m	5000 mm	10,5 W/m	120 LED/m	89,95 €



2835-120-24V-3000K-10M

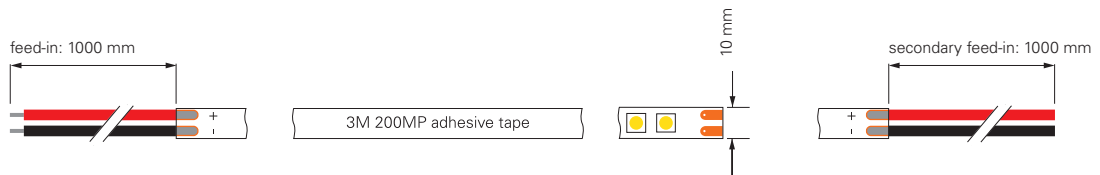
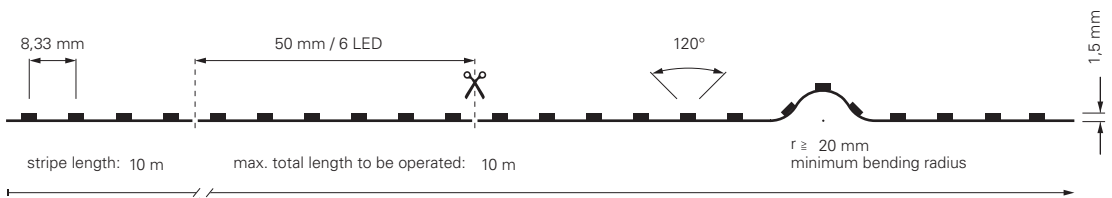

item	colour temperature	efficiency	light current	dimensions L	power	light source	price
840291	ww 3000K	74 lm/W	705 lm/m	10000 mm	9,5 W/m	120 LED/m	449,95 €



2216-266-24V-2700K / 3000K / 4000K-5M

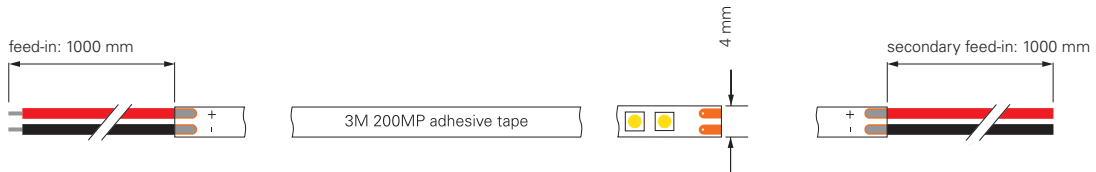
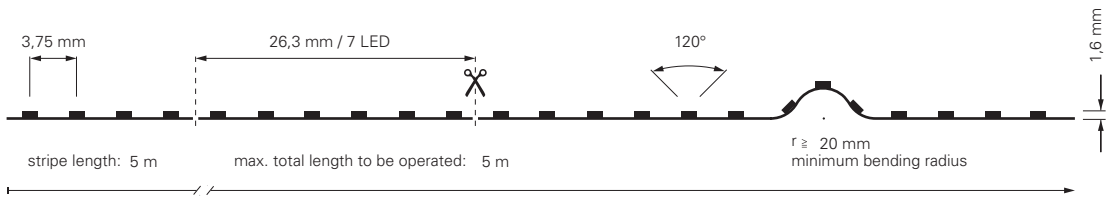

item	colour	temperature	efficiency	light current	dimensions L	power	light source	price
840175	ww	2700K	90 lm/W	995 lm/m	5000 mm	11,0 W/m	266 LED/m	189,95 €
840210	ww	3000K	99 lm/W	1090 lm/m	5000 mm	11,0 W/m	266 LED/m	189,95 €
840267	nw	4000K	96 lm/W	1100 lm/m	5000 mm	11,5 W/m	266 LED/m	189,95 €



3528-180-24V-2700K-5M / 3000K-5M / 3000K-50M / 4000K-5M / 4000K-50M

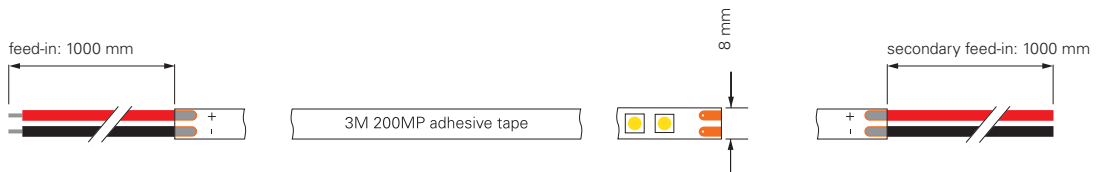
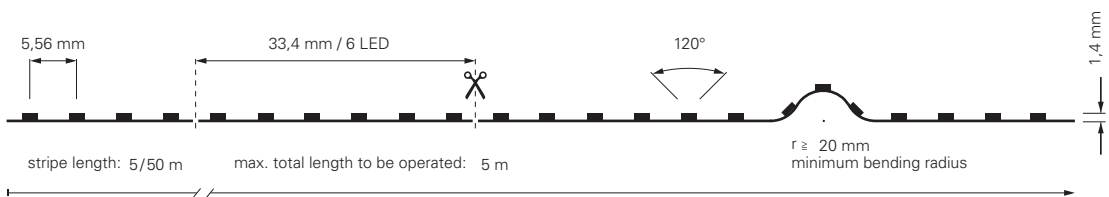

item	colour	temperature	efficiency	light current	dimensions L	power	light source	price
840178	ww	2700K	79 lm/W	1110 lm/m	5000 mm	14,0 W/m	180 LED/m	139,95 €
840179	ww	3000K	81 lm/W	1100 lm/m	5000 mm	13,5 W/m	180 LED/m	139,95 €
930512	ww	3000K	81 lm/W	1100 lm/m	50000 mm	13,5 W/m	180 LED/m	1.299,95 €
840180	nw	4000K	90 lm/W	1220 lm/m	5000 mm	13,5 W/m	180 LED/m	139,95 €
930513	nw	4000K	91 lm/W	1225 lm/m	50000 mm	13,5 W/m	180 LED/m	1.299,95 €



3528-240-24V-2700K-5M / 3000K-5M / 3000K-50M / 4000K-5M / 4000K-50M

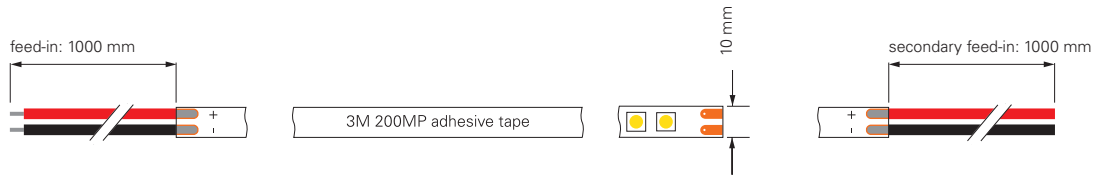
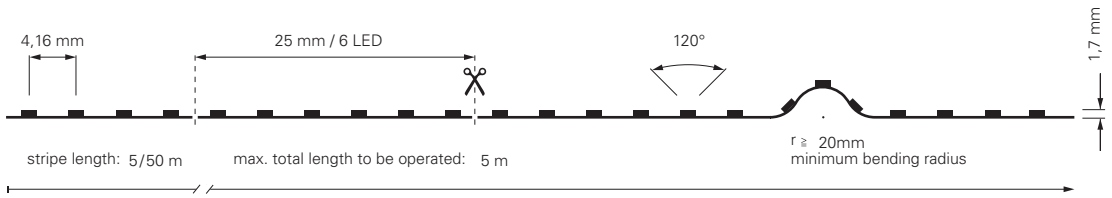

item	colour temperature	efficiency	light current	dimensions L	power	light source	price
840192	ww 2700K	66 lm/W	1215 lm/m	5000 mm	18,5 W/m	240 LED/m	181,95 €
840193	ww 3000K	84 lm/W	1605 lm/m	5000 mm	19,0 W/m	240 LED/m	181,95 €
930514	ww 3000K	84 lm/W	1605 lm/m	50000 mm	19,0 W/m	240 LED/m	1.629,95 €
840194	nw 4000K	89 lm/W	1770 lm/m	5000 mm	20,0 W/m	240 LED/m	181,95 €
930515	nw 4000K	89 lm/W	1770 lm/m	50000 mm	20,0 W/m	240 LED/m	1.629,95 €

CV

24 Volt

SMD 3528

Ra 90

+

-

1 CH

IP20

- 15°C
+ 50°C

2835-120-24V-3000K / 6000K-5M

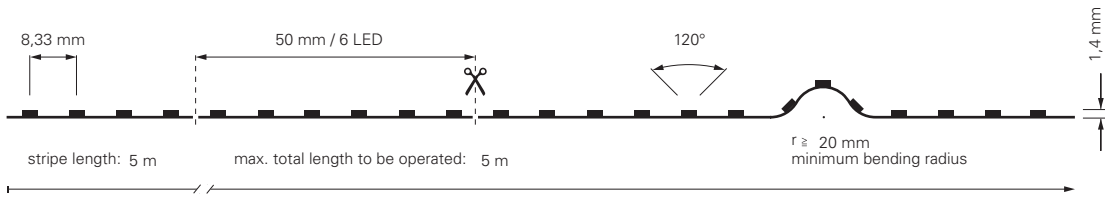

item	colour temperature	efficiency	light current	dimensions L	power	light source	price
840122	ww 3000K	76 lm/W	1595 lm/m	5000 mm	21 W/m	120 LED/m	215,95 €
840124	cw 6000K	86 lm/W	1720 lm/m	5000 mm	20 W/m	120 LED/m	215,95 €



2835-160-24V-3000K / 4000K-5M

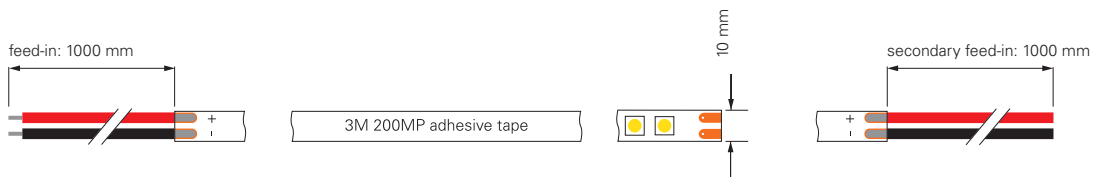
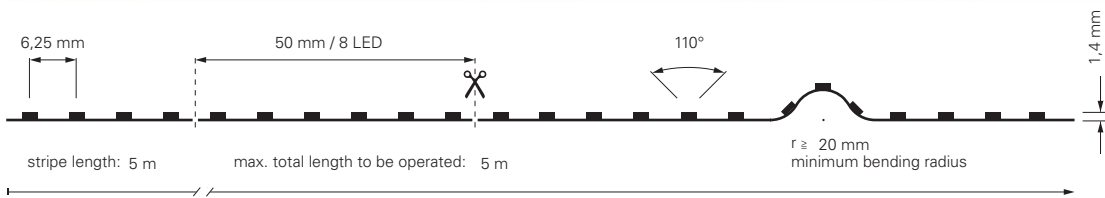

item	colour temperature	efficiency	light current	dimensions L	power	light source	price
840331	ww 3000K	114 lm/W	2570 lm/m	5000 mm	22,5 W/m	160 LED/m	279,95 €
840332	nw 4000K	125 lm/W	2815 lm/m	5000 mm	22,5 W/m	160 LED/m	279,95 €



2835-160-24V-3000K / 4000K-5M-SILIKON

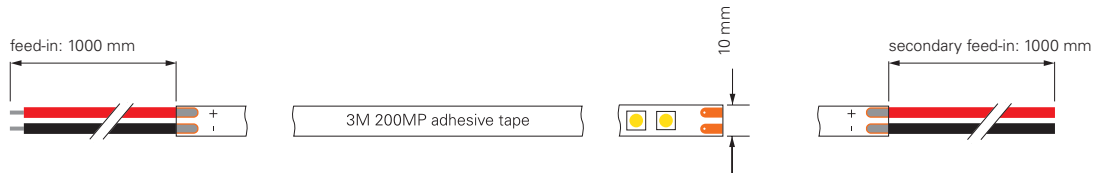
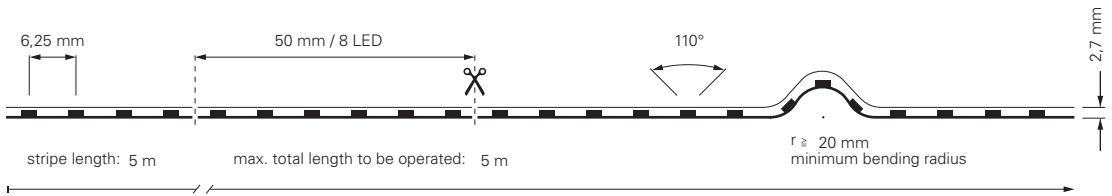

item	colour temperature	efficiency	light current	dimensions L	power	light source	price
840333	ww 3000K	112 lm/W	2520 lm/m	5000 mm	22,5 W/m	160 LED/m	289,95 €
840334	nw 4000K	114 lm/W	2555 lm/m	5000 mm	22,5 W/m	160 LED/m	289,95 €



3528-180-24V-2700K / 3000K-5M-SILIKON

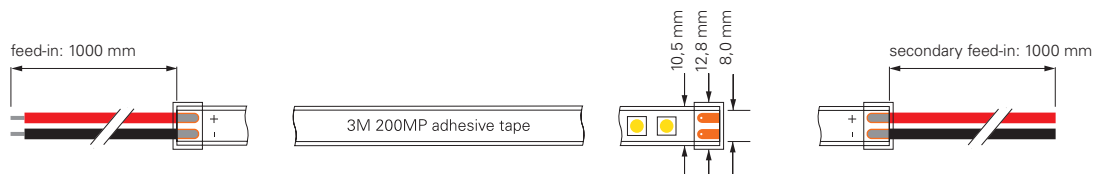
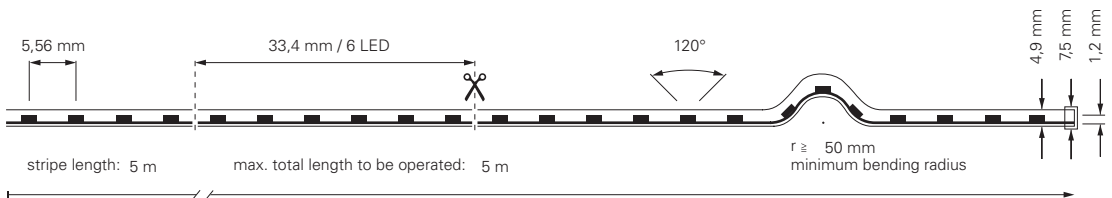

item	colour temperature	efficiency	light current	dimensions L	power	light source	price
840186	ww 2700K	78 lm/W	900 lm/m	5000 mm	11,5 W/m	180 LED/m	205,95 €
840187	ww 3000K	85 lm/W	930 lm/m	5000 mm	11,0 W/m	180 LED/m	205,95 €



incl. accessories: 10x retaining bracket, 20x stainless steel screw, 2x endcap

STANDARD | 1CH | 48V

48V LED stripes in warm white 3000K, neutral white 4000K
These LED stripes are ideally suited when the focus is on long distances to be illuminated. Due to the voltage of 48V, distances of up to 50m can be operated at a stretch.



2835-78-48V-3000K-15M / 3000K-50M / 4000K-15M / 4000K-50M

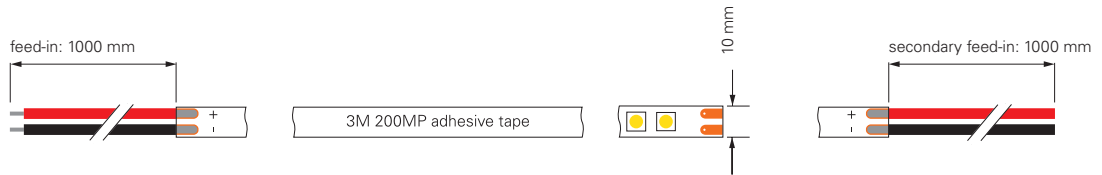
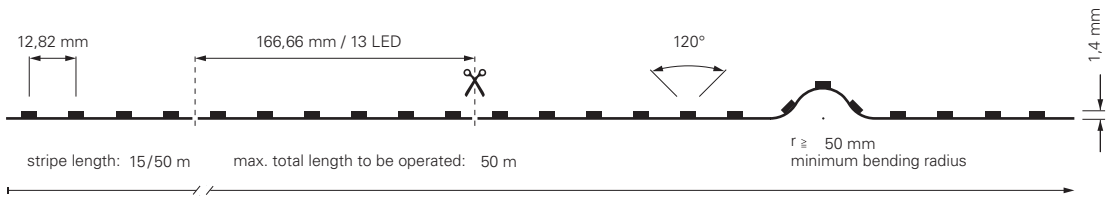

item	colour temperature	efficiency	light current	dimensions L	power	light source	price
840318	ww 3000K	121 lm/W	485 lm/m	15000 mm	4 W/m	78 LED/m	489,95 €
840337	ww 3000K	121 lm/W	485 lm/m	50000 mm	4 W/m	78 LED/m	1.499,95 €
840320	nw 4000K	133 lm/W	530 lm/m	15000 mm	4 W/m	78 LED/m	499,95 €
840339	nw 4000K	133 lm/W	530 lm/m	50000 mm	4 W/m	78 LED/m	1.525,95 €



2835-78-48V-3000K-15M / 3000K-50M / 4000K-15M / 4000K-50M-SILIKON

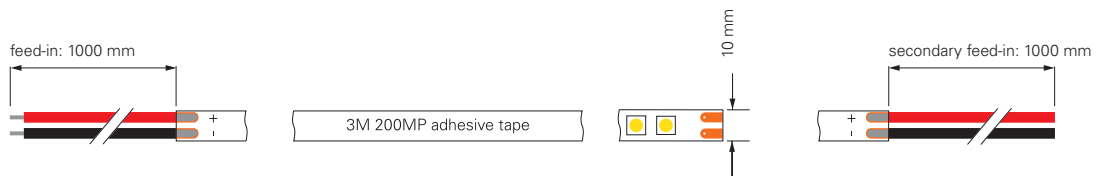
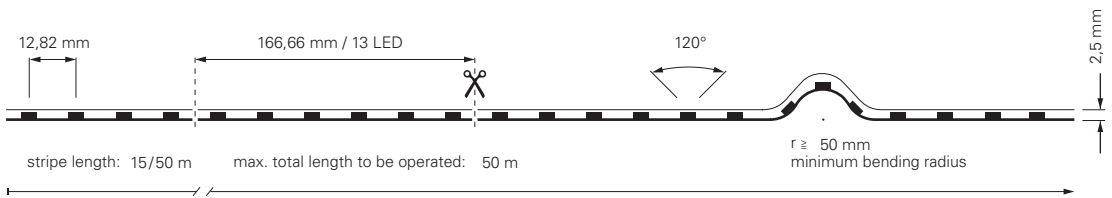

item	colour temperature	efficiency	light current	dimensions L	power	light source	price
840317	ww 3000K	100 lm/W	400 lm/m	15000 mm	4 W/m	78 LED/m	549,95 €
840338	ww 3000K	100 lm/W	400 lm/m	50000 mm	4 W/m	78 LED/m	1.725,95 €
840319	nw 4000K	114 lm/W	455 lm/m	15000 mm	4 W/m	78 LED/m	549,95 €
840340	nw 4000K	114 lm/W	455 lm/m	50000 mm	4 W/m	78 LED/m	1.799,95 €



STANDARD | 2CH | 12V

standard stripes in warm white 2700K - cold white 6500K,
warm white 3000K - cold white 6500K

With these standard stripes you have the possibility to mix
white tones between 2700K and 6500K / 3000K and 6500K
through a flexible control.



3528-120-12V-3000K+6500K-5M

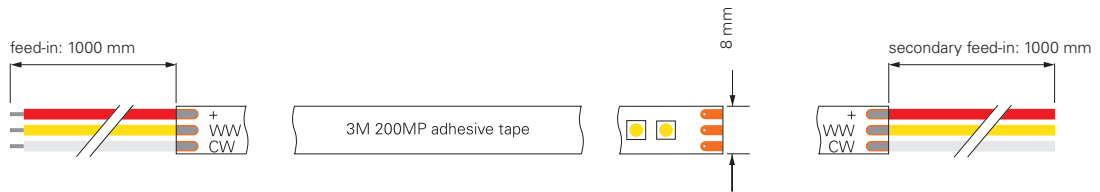
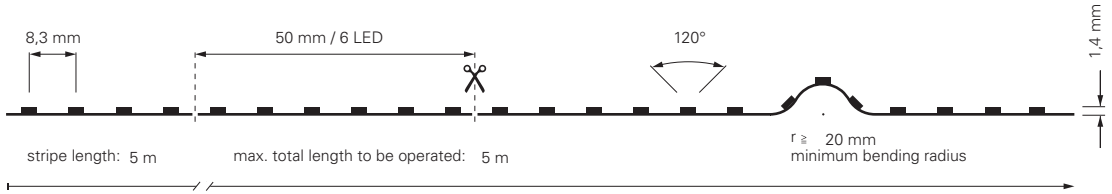

item	colour temperature	efficiency	light current	dimensions L	power	light source	price
840097	WW CW 3000-6500K	76 lm/W	760 lm/m	5000 mm	10 W/m	120 LED/m	139,95 €



3528-120-12V-3000K-6500K-5M

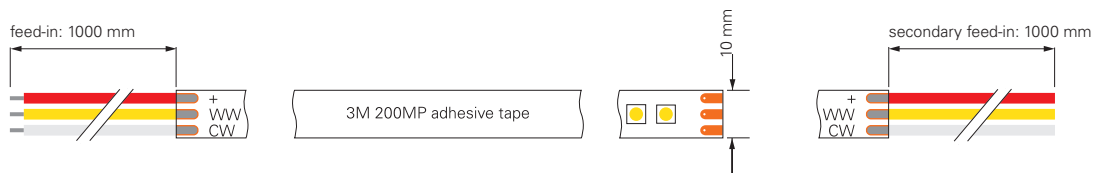
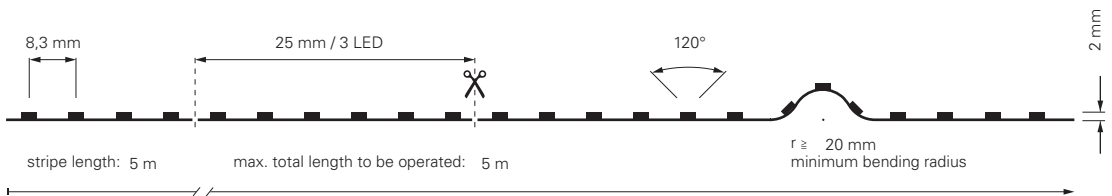

item	colour temperature	efficiency	light current	dimensions L	power	light source	price
840142	WW CW 3000-6500K	98 lm/W	1025 lm/m	5000 mm	10,5 W/m	120 LED/m	219,95 €



STANDARD | 2CH | 24V

standard stripes in warm white 2700K - cold white 6500K,
warm white 3000K - cold white 6500K

These LED stripes are ideally suited for all standard applications and special assemblies with the most diverse requirements. With these standard stripes, you have the option of mixing white tones between 2700K and 6500K /3000K and 6500K through flexible control.



2216-196-24V-3000-6500K-5M

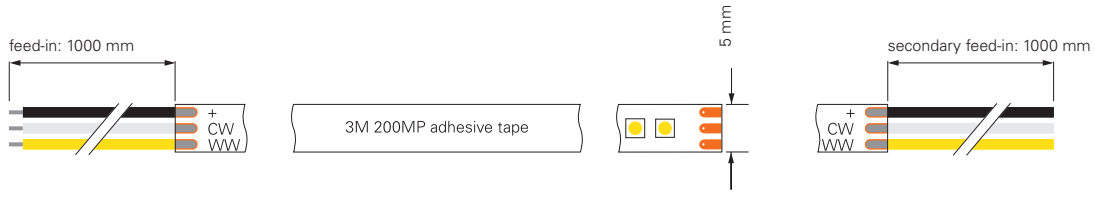
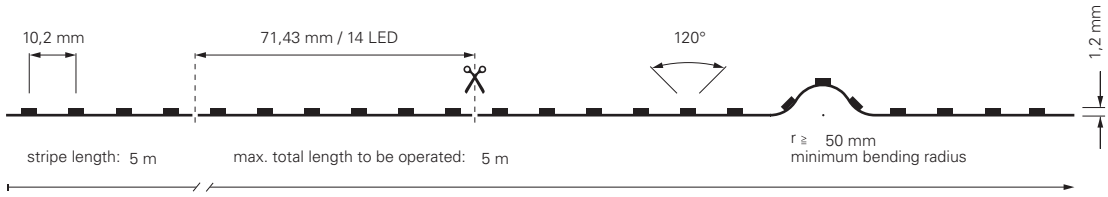

item	colour temperature	efficiency	light current	dimensions L	power	light source	price
840350	WW CW 3000-6500K	93 lm/W	1025 lm/m	5000 mm	11 W/m	196 LED/m	139,95 €

CV

24 Volt

SMD 2216

Ra 90

2 CH

IP20

- 15°C
+ 50°C

2835-120-24V-2700-6500K-5M

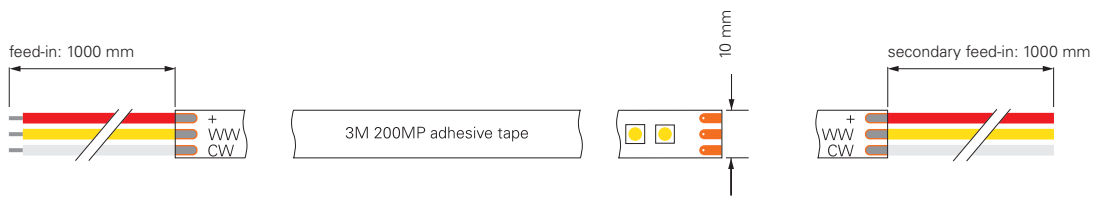
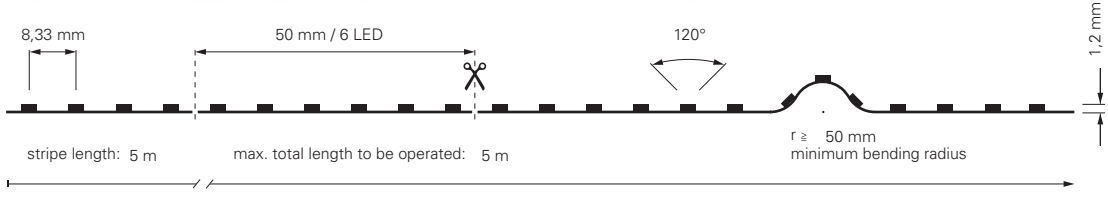

item	colour temperature	efficiency	light current	dimensions L	power	light source	price
840378	WW CW 2700-6500K	103 lm/W	1765 lm/m	5000 mm	17,2 W/m	140 LED/m	199,95 €

CV

24 Volt

SMD 2835

Ra 90

2 CH

IP20

- 15°C
+ 50°C

2835-120-24V-2700-6500K-5M-SILIKON

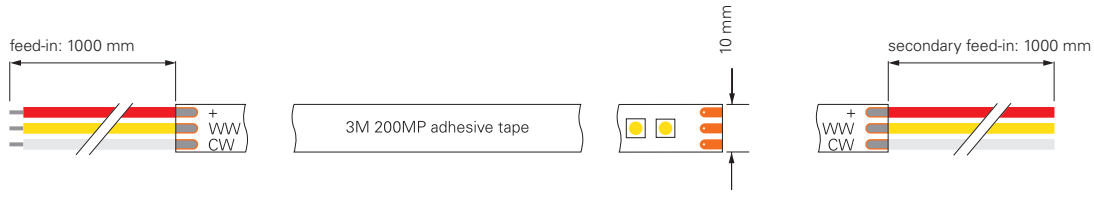
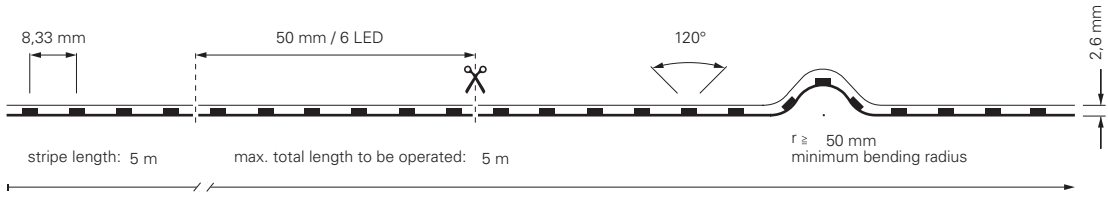

item	colour	temperature	efficiency	light current	dimensions L	power	light source	price	
840379	WW	CW	2700-6500K	105 lm/W	1470 lm/m	5000 mm	14 W/m	140 LED/m	219,95 €

CV

24 Volt

SMD 2835

Ra 90

2 CH

IP44

-15°C
+50°C

2216-196-24V-3000-6500K-5M-SILIKON

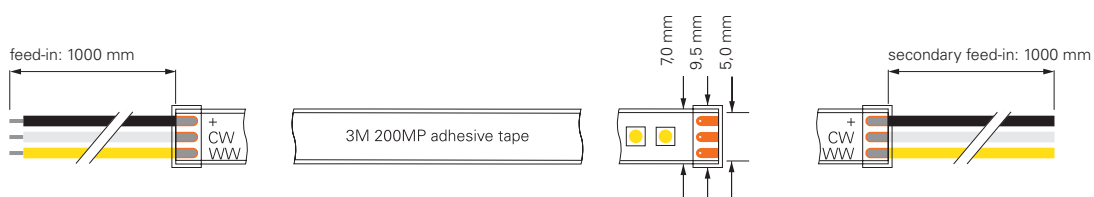
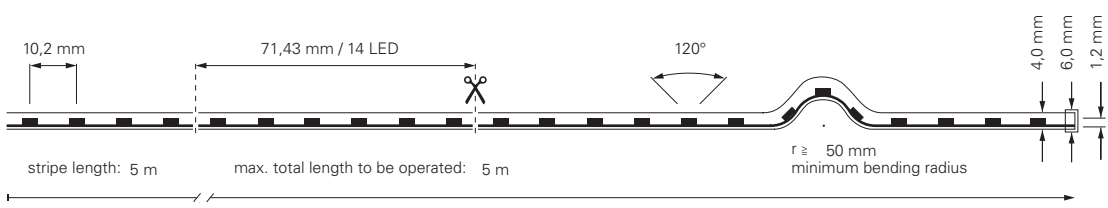

item	colour	temperature	efficiency	light current	dimensions L	power	light source	price	
840349	WW	CW	3000-6500K	86 lm/W	1070 lm/m	5000 mm	12,5 W/m	196 LED/m	196,95 €

CV

24 Volt

SMD 2216

Ra 90

2 CH

IP65

-15°C
+50°C

incl. accessories: 10x retaining bracket, 20x stainless steel screw, 2x endcap



STANDARD | 3CH | 24V

These LED stripes in RGB are ideally suited for all standard applications and special assemblies with the most diverse requirements. With these standard stripes, you have the option of setting individual colours or flexible control to set individual colours or mixed colours as desired.



3535-120-24V-RGB-5M

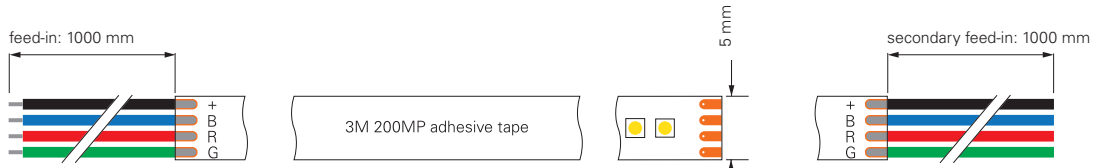
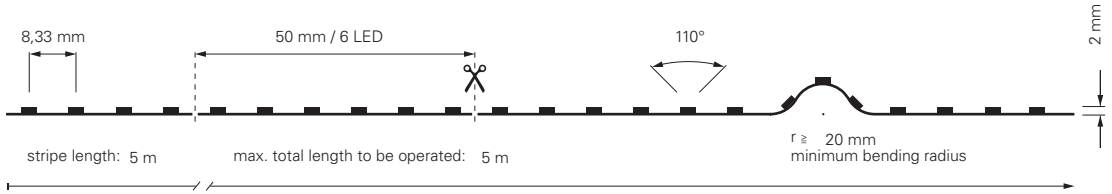

item	colour temperature	efficiency	light current	dimensions L	power	light source	price
840276	RGB 470-630 nm	45 lm/W	500 lm/m	5000 mm	11 W/m	120 LED/m	119,95 €

CV

24 Volt

SMD 3535

3 CH

IP20

-15°C
+50°C

5050-60-24V-RGB-5M

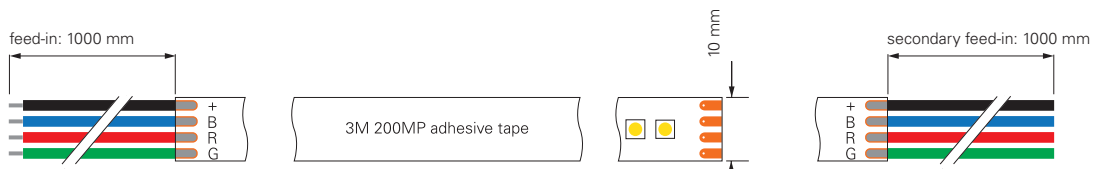
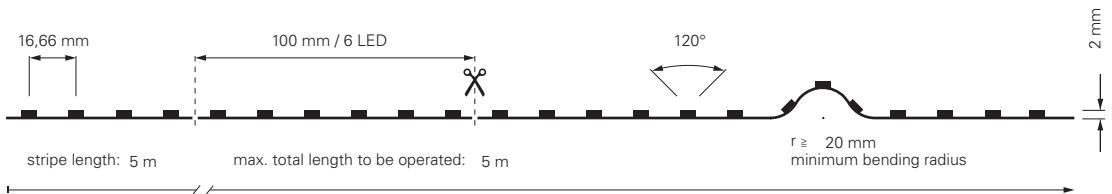

item	colour temperature	efficiency	light current	dimensions L	power	light source	price
840254	RGB 470-630 nm	45 lm/W	580 lm/m	5000 mm	13 W/m	60 LED/m	149,95 €

CV

24 Volt

SMD 5050

3 CH

IP20

-15°C
+50°C

5050-96-24V-RGB-5M / RGB-50M

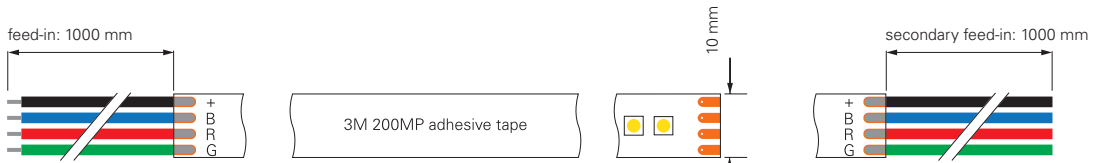
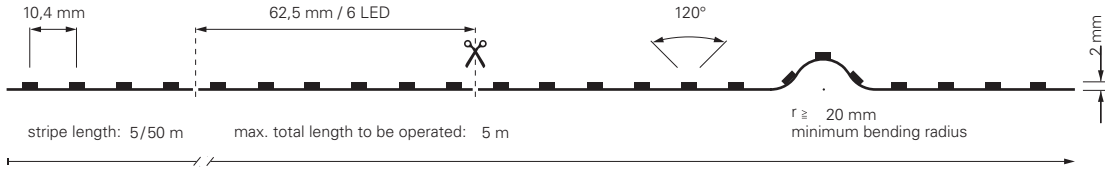

item	colour temperature	efficiency	light current	dimensions L	power	light source	price
840147	450-630 nm	48 lm/W	665 lm/m	5000 mm	14,0 W/m	96 LED/m	189,95 €
930516	450-630 nm	46 lm/W	665 lm/m	50000 mm	14,5 W/m	96 LED/m	1.749,95 €



5050-120-24V-RGB-5M

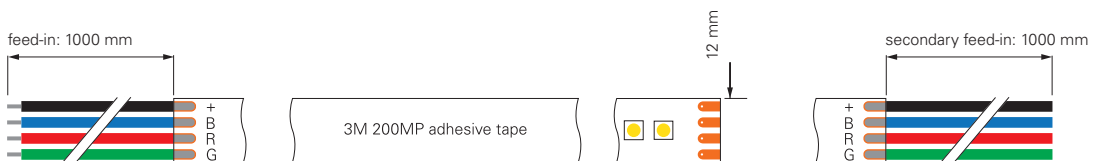
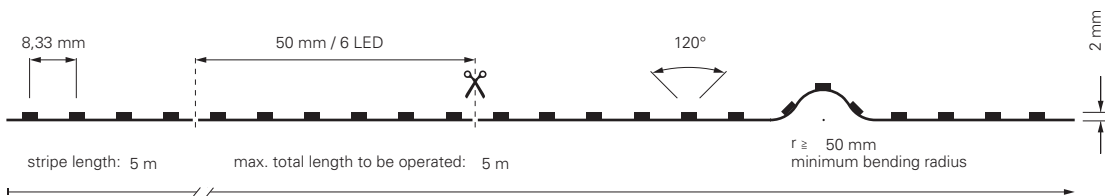

item	colour temperature	efficiency	light current	dimensions L	power	light source	price
840352	460-620 nm	38 lm/W	1055 lm/m	5000 mm	28 W/m	120 LED/m	209,95 €



5050-120-24V-RGB-5M-SILIKON

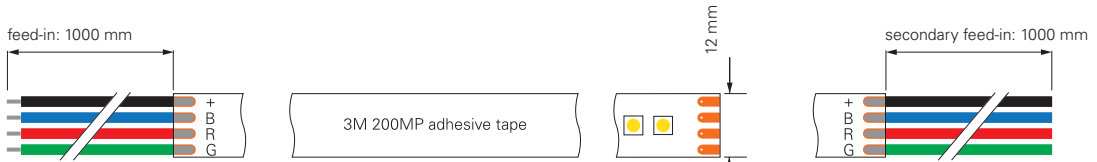
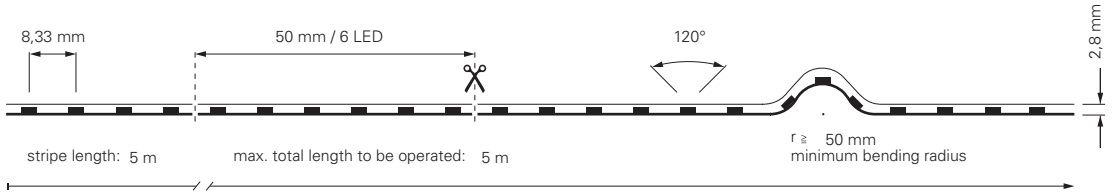

item	colour temperature	efficiency	light current	dimensions L	power	light source	price
840351	RGB 460-620 nm	38 lm/W	1045 lm/m	5000 mm	27,5 W/m	120 LED/m	239,95 €



5050-60-24V-RGB-5M-SILIKON

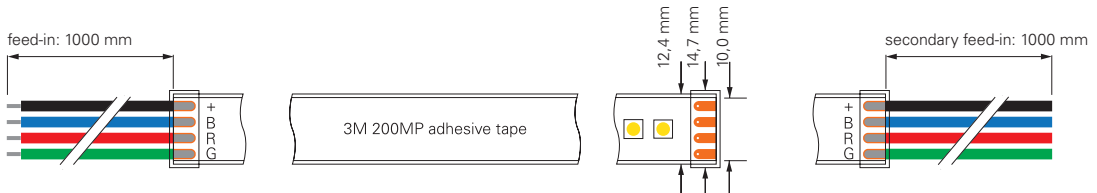
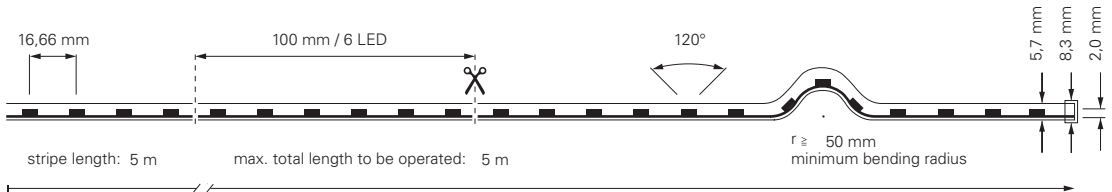

item	colour temperature	efficiency	light current	dimensions L	power	light source	price
840256	RGB 470-630 nm	42 lm/W	530 lm/m	5000 mm	12,5 W/m	60 LED/m	179,95 €



incl. accessories: 10x retaining bracket, 20x stainless steel screw, 2x endcap

STANDARD | 4CH | 24V

LED stripes in RGB + 3000K, 4000K, 6500K

These LED stripes are ideally suited for all standard applications and special assemblies with the most diverse requirements. With these LED stripes, you have the option of setting single colours, warm white, neutral white, cold white or mixed colours as desired through flexible control.



5050-96-24V-RGB+3000K-5M

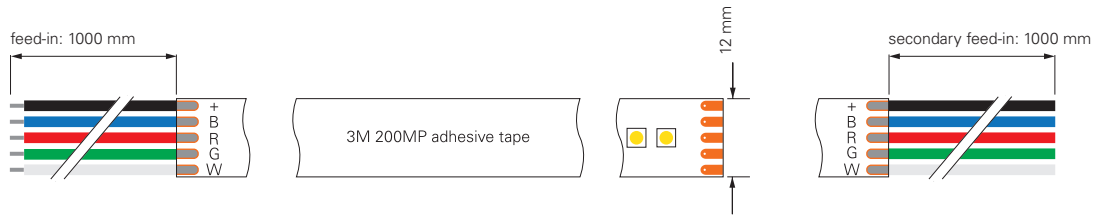
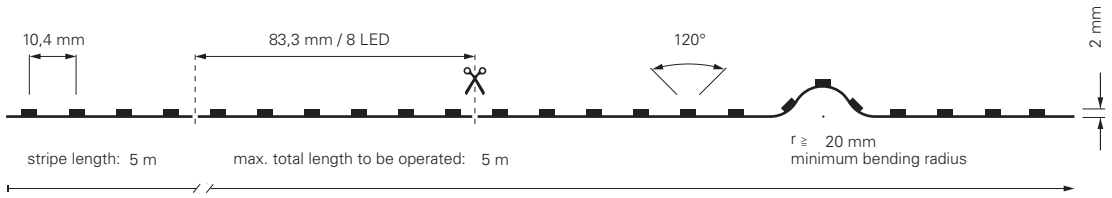

item	colour temperature	efficiency	light current	dimensions L	power	light source	price
840144	RGB WW 450-630 nm + 3000K	42 lm/W	585 lm/m	5000 mm	14W/m	96 LED/m	189,95 €



5050-60-24V-RGB+3000K-5M + 5050-60-24V-RGB+3000K-50M

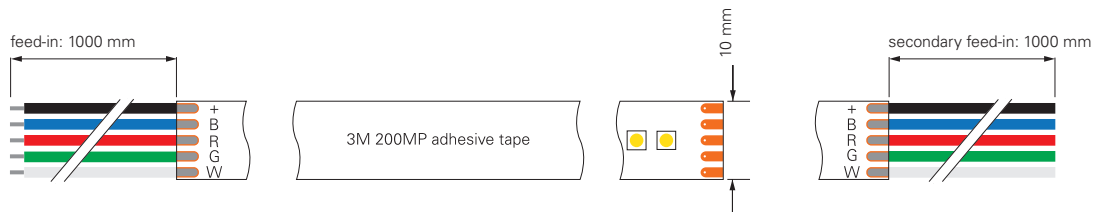
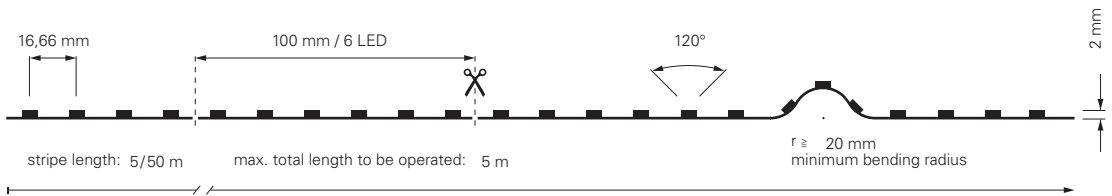

item	colour temperature	efficiency	light current	dimensions L	power	light source	price
840236	RGB WW 450-630 nm + 3000K	51 lm/W	820 lm/m	5000 mm	16 W/m	60 LED/m	160,95 €
930517	RGB WW 450-630 nm + 3000K	51 lm/W	820 lm/m	50000 mm	16 W/m	60 LED/m	1.445,95 €



5050-60-24V-RGB+4000K-5M

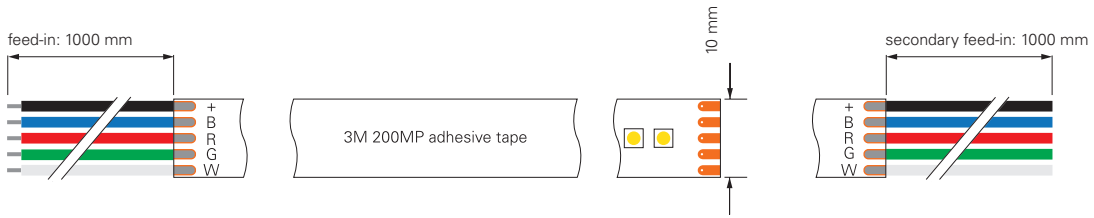
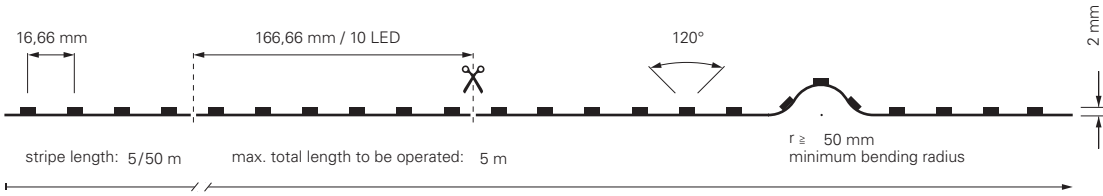

item	colour temperature	efficiency	light current	dimensions L	power	light source	price
840353	RGB NW 450-630 nm + 4000K	47 lm/W	775 lm/m	5000 mm	16,5 W/m	60 LED/m	169,95 €



3535-192-24V-RGB+3000K-5M / RGB+4000K-5M

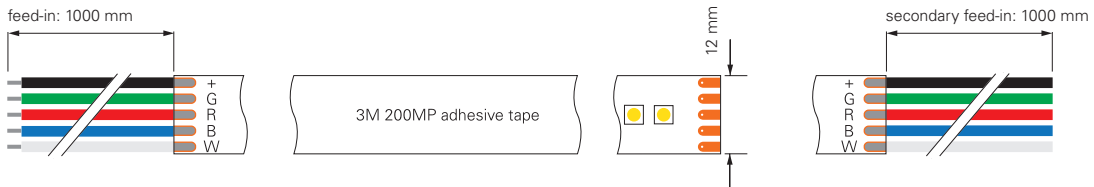
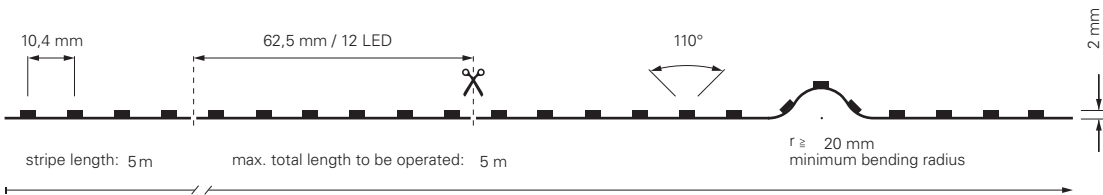

item	colour temperature	efficiency	light current	dimensions L	power	light source	price
840308	RGB WW 470-630 nm + 3000K	43 lm/W	955 lm/m	5000 mm	22 W/m	192 LED/m	199,95 €
840309	RGB NW 470-630 nm + 4000K	45 lm/W	985 lm/m	5000 mm	22 W/m	192 LED/m	199,95 €



5050-60-24V-RGB+4000K-5M-SILIKON

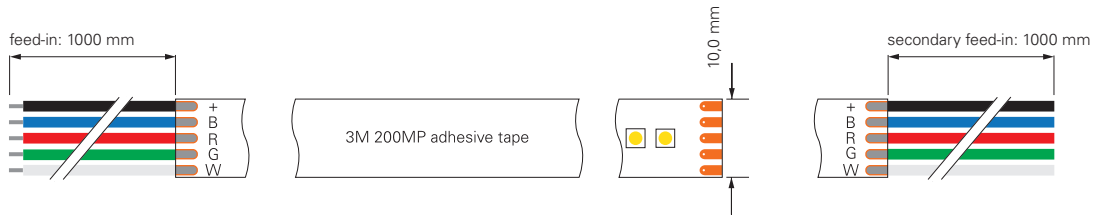
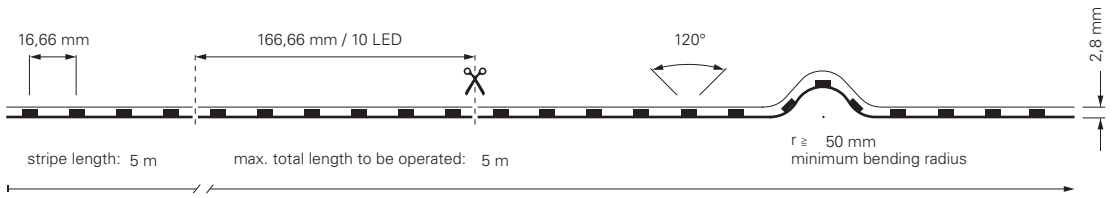

item	colour temperature	efficiency	light current	dimensions L	power	light source	price
840373	RGB NW 450-630 nm + 4000K	48 lm/W	765 lm/m	5000 mm	16,0 W/m	60 LED/m	179,95 €



5050-60-24V-RGB+3000K-5M-SILIKON

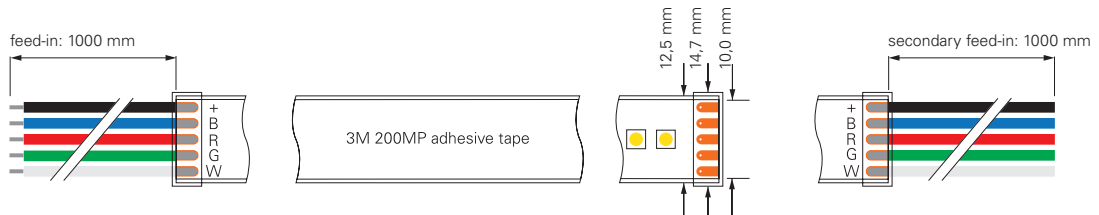
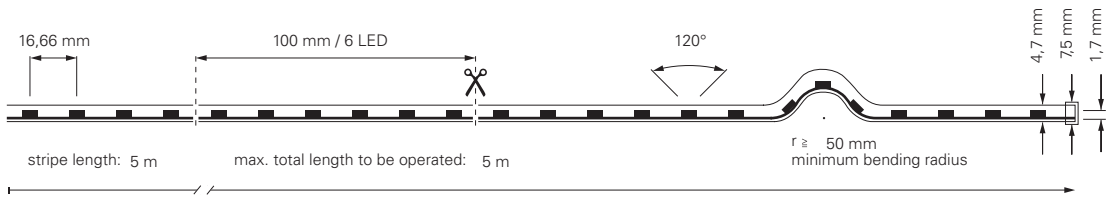

item	colour temperature	efficiency	light current	dimensions L	power	light source	price
840239	RGB WW 450-630 nm + 3000K	49 lm/W	735 lm/m	5000 mm	15 W/m	60 LED/m	193,95 €



incl. accessories: 10x retaining bracket, 20x stainless steel screw, 2x endcap

D FLEX LINE – FLEXIBLE IN MANY WAYS

Are you looking for a flexible, water-protected and homogeneously illuminated LED stripe? With our D FLEX LINE series, we combine all requirements in one continuous row. Our D Flex Line stripes are available in two basic versions, as Top View and Side View. The difference lies in the built-in positioning of the LED stripes, because this results in two significant differences in the possible mounting / placement of the stripes.

Due to a completely flexible potting, the D FLEX LINE achieve a degree of protection of up to IP68 as well as a completely homogeneous light pattern in the different LED stripes versions warm white, RGB and RGB + warm white due to the respective placement of the LED stripe. The shape and encapsulation also have a significant influence on the radiation behaviour of our strips, allowing you to achieve a beam angle of up to 180°.

The maximum total length to be operated is 5m. You can shorten the continuous rooflights at the and marked points. Each D Flex Line stripe is supplied with a feed and secondary feed of 3m each. This ensures a flexible, convenient and simple installation is guaranteed. The feed is supplied with tinned wire ends. In addition, our D FLEX LINE tapes are flame retardant and resistant to UV, chlorinated water, alt water and commercial cleaners [note content concentrations, not sea water resistant].



TOP VIEW

The LED stripe is arranged / installed horizontally, which means that the flex stripe can be bent up and down. [note the respective minimum bending radius]

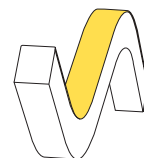

D FLEX LINE TOP VIEW IP68 3000K

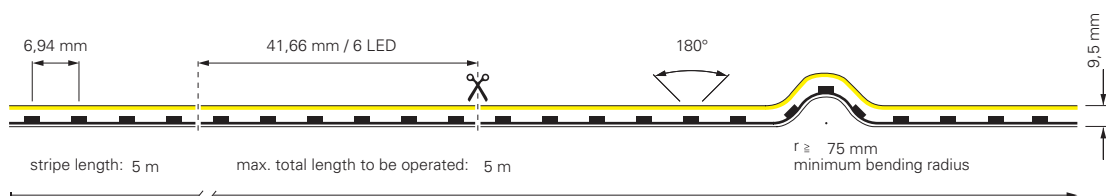

item	colour	temperature	efficiency	light current	dimensions L	power	light source	price
840285	ww	3000K	70 lm/W	730 lm/m	5000 mm	10,5 W/m	144 LED/m	479,95 €

CV	24 Volt	SMD 3014	Ra 80	1 CH	IP68	-15°C +50°C
----	---------	----------	-------	------	------	----------------

incl. accessories: 10x retaining clip, 10x screw, 2x endcap

930446	profile for D Flex Line MINI aluminium anodized L x W x H: 1000 x 12 x 13 mm	14,94 €
930445	profile for D Flex Line MINI plastic transparent L x W x H: 1000 x 12 x 13 mm	10,95 €
930531	assembly set for D Flex Line 10 x 10 mm	10,95 €
930593	gel glue for gluing the end caps 3g	5,95 €

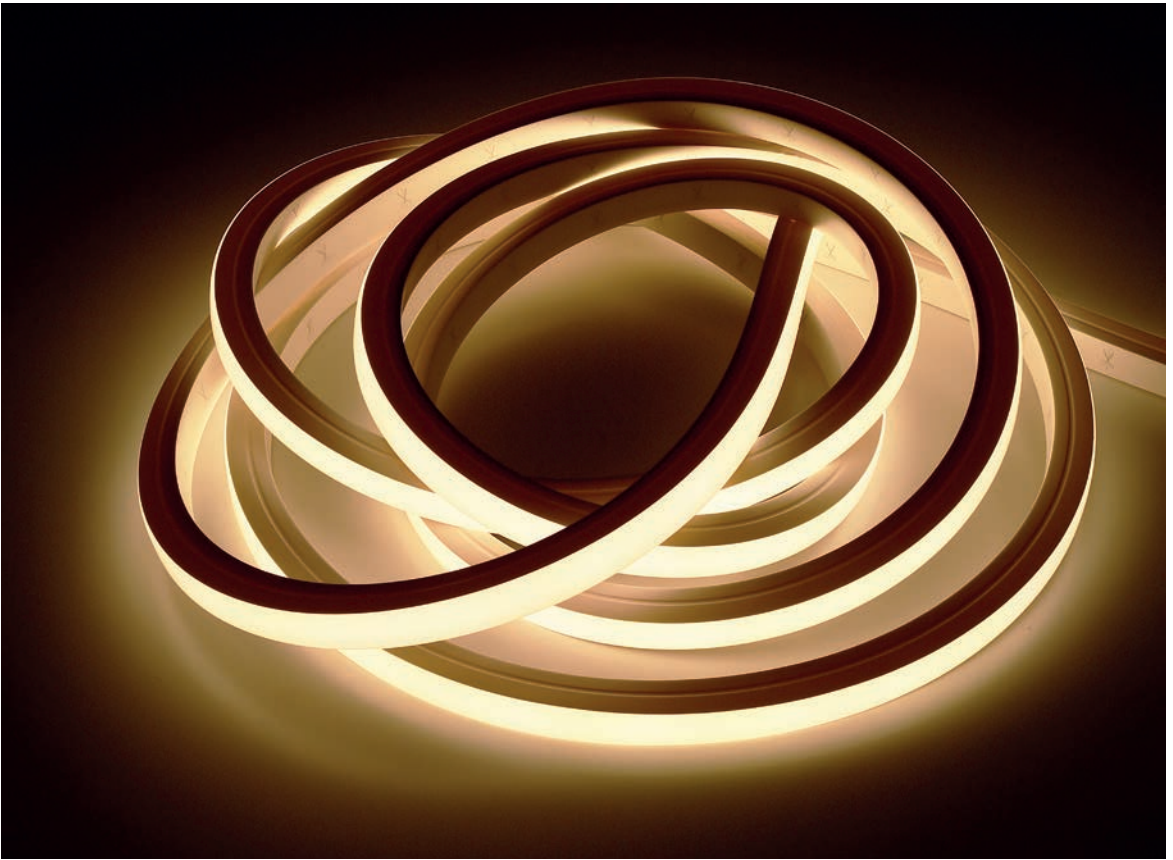

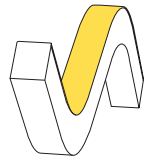

D FLEX LINE MINITOP VIEW IP68 3000K

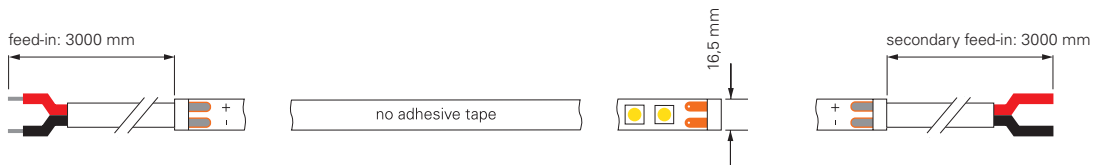
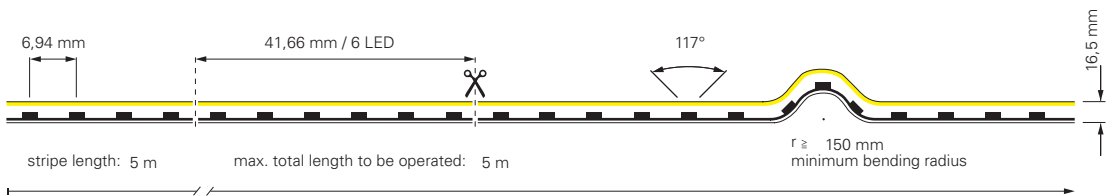

item	colour	temperature	efficiency	light current	dimensions L	power	light source	price
840288	ww	3000K	49 lm/W	515 lm/m	5000 mm	10,5 W/m	144 LED/m	749,95 €



incl. accessories: 10x retaining clip, 10x screw, 2x endcap

930448	profile for D Flex Line TOP aluminium anodized L x W x H: 1000 x 19 x 18 mm	14,94 €
930449	profile for D Flex Line TOP plastic transparent L x W x H: 1000 x 19 x 18 mm	11,95 €
930533	assembly set for D Flex Line 16 x 15 mm	10,95 €
930593	gel glue for gluing the end caps 3g	5,95 €

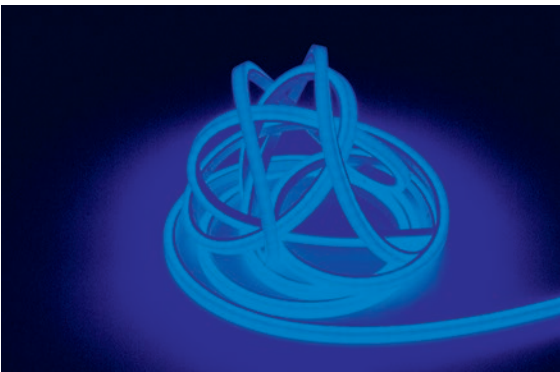
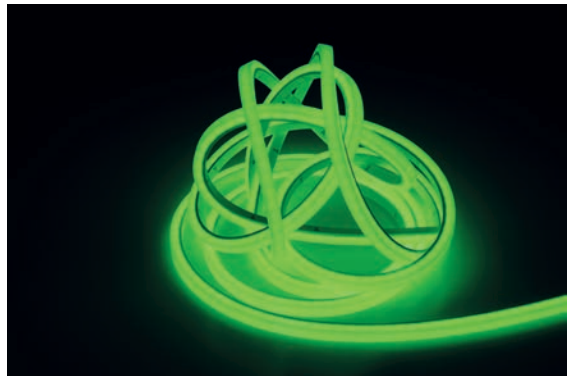
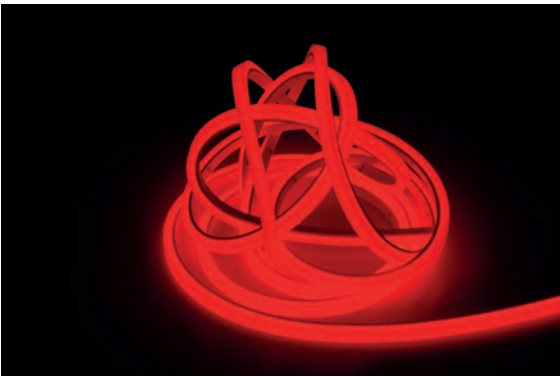
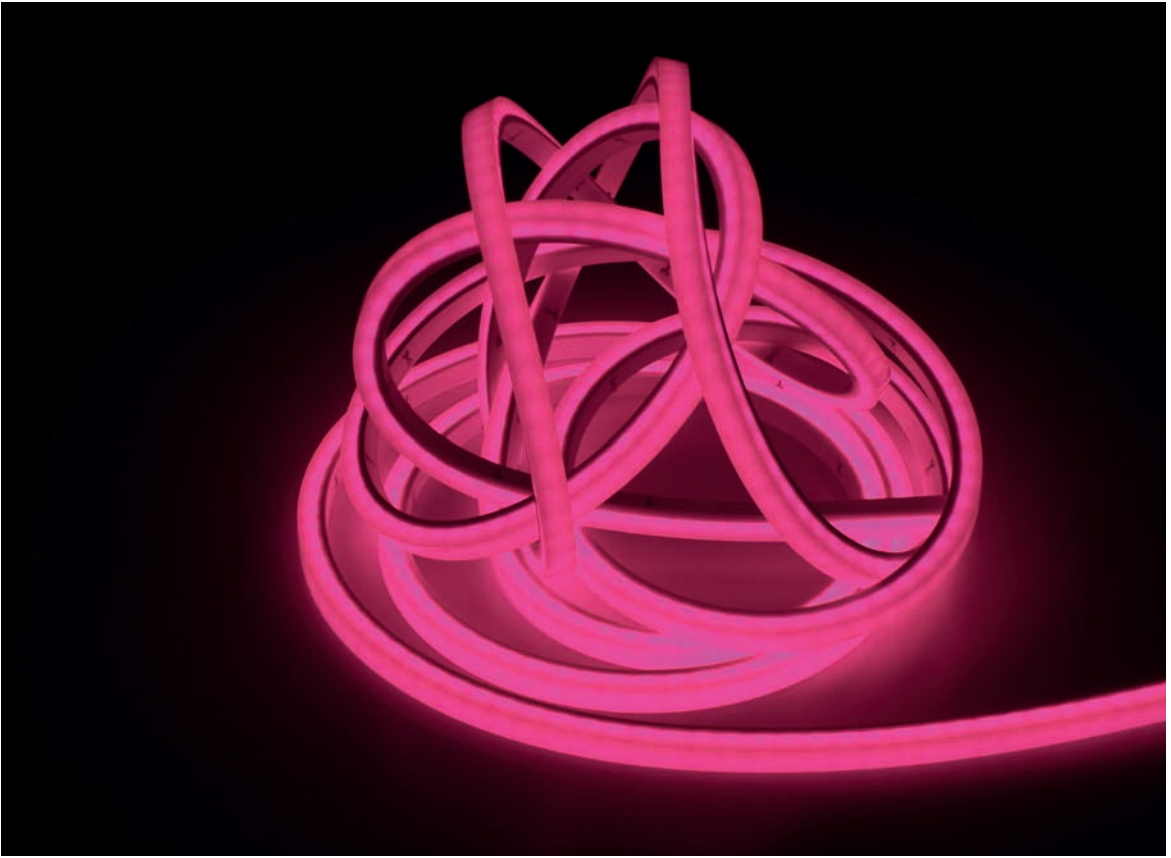



D FLEX LINE TOP VIEW IP68 RGB

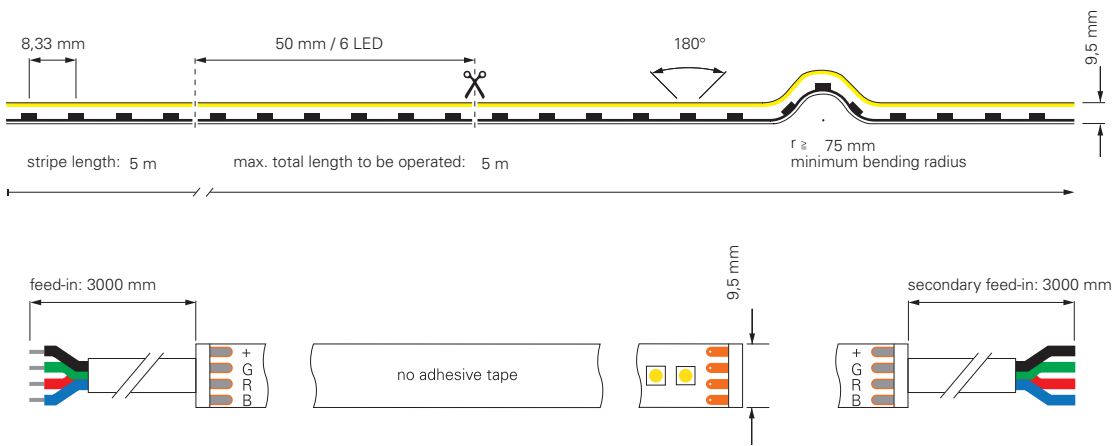

item	colour temperature	efficiency	light current	dimensions L	power	light source	price
840286	460-620 nm	32 lm/W	315 lm/m	5000 mm	10 W/m	120 LED/m	519,95 €



incl. accessories: 10x retaining clip, 10x screw, 2x endcap

930446	profile for D Flex Line MINI aluminium anodized L x W x H: 1000 x 12 x 13 mm	14,94 €
930445	profile for D Flex Line MINI plastic transparent L x W x H: 1000 x 12 x 13 mm	10,95 €
930531	assembly set for D Flex Line 10 x 10 mm	10,95 €
930593	gel glue for gluing the end caps 3g	5,95 €



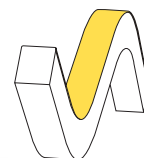

D FLEX LINE TOP VIEW IP68 RGBW

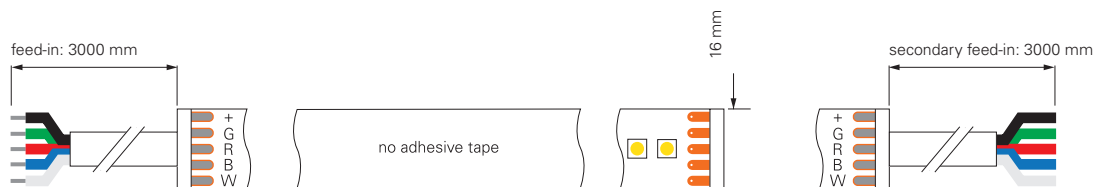
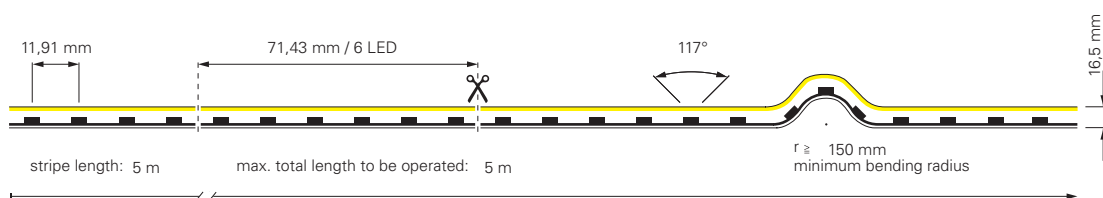

item	colour temperature	efficiency	light current	dimensions L	power	light source	price
840289	470-620 nm	30 lm/W	320 lm/m	5000 mm	10,5 W/m	84 LED/m	779,95 €



incl. accessories: 10x retaining clip, 10x screw, 2x endcap

930448	profile for D Flex Line TOP aluminium anodized L x W x H: 1000 x 19 x 18 mm	14,94 €
930449	profile for D Flex Line TOP plastic transparent L x W x H: 1000 x 19 x 18 mm	11,95 €
930533	assembly set for D Flex Line 16 x 15 mm	10,95 €
930593	gel glue for gluing the end caps 3g	5,95 €



SIDE VIEW

The LED stripe is arranged / installed vertically, which means that the flex stripe can be bent to the left and right. [note the respective minimum bending radius]

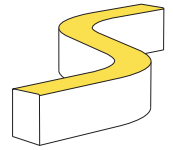

D FLEX LINE MINI SIDE VIEW IP44 3000K

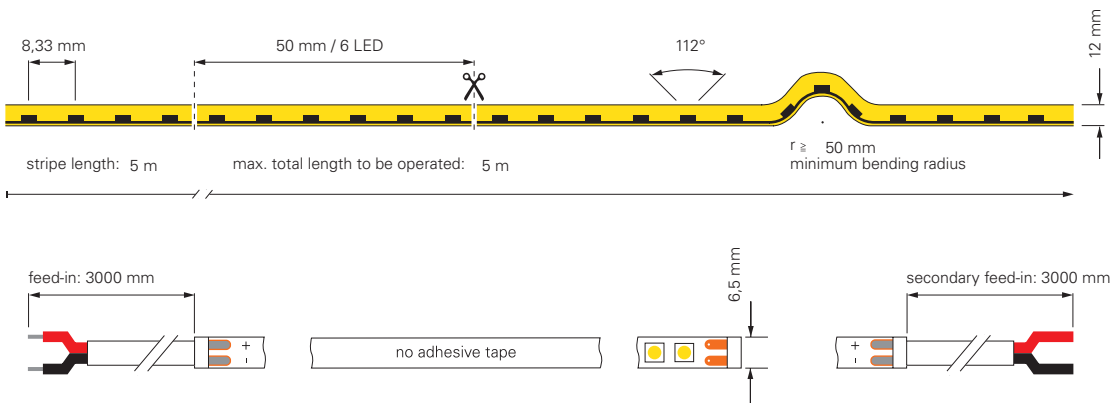

item	colour	temperature	efficiency	light current	dimensions L	power	light source	price
840376	ww	3000K	30 lm/W	285 lm/m	5000 mm	9,5 W/m	120 LED/m	359,95 €

CV	24 Volt	SMD 3014	Ra 90	1 CH	IP44	-15°C +50°C
----	---------	----------	-------	------	------	----------------

incl. accessories: 10x retaining clip, 10x screw, 2x endcap

930443	profile for D Flex Line aluminium anodized L x W x H: 1000 x 9 x 13 mm	12,95 €
930444	Flex profile for D Flex Line aluminium L x W x H: 500 x 9 x 12 mm	21,95 €
930530	assembly set for D Flex Line 6,5 x 12 mm	9,95 €
930593	gel glue for gluing the end caps 3g	5,95 €



D FLEX LINE MINI SIDE VIEW IP68 3000K

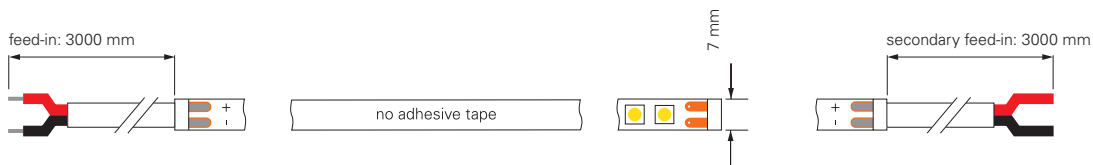
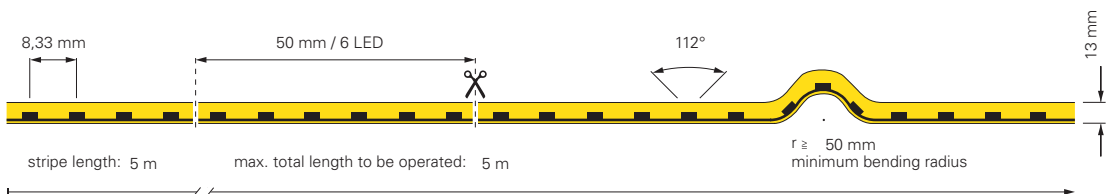

item	colour	temperature	efficiency	light current	dimensions L	power	light source	price
840283	ww	3000K	37 lm/W	295 lm/m	5000 mm	8 W/m	120 LED/m	559,95 €



incl. accessories: 10x retaining clip, 10x screw, 2x endcap

930443	profile for D Flex Line aluminium anodized L x W x H: 1000 x 9 x 13 mm	12,95 €
930444	Flex profile for D Flex Line aluminium L x W x H: 500 x 9 x 12 mm	21,95 €
930530	assembly set for D Flex Line 6,5 x 12 mm	9,95 €
930593	gel glue for gluing the end caps 3g	5,95 €



D FLEX LINE MINI SIDE VIEW IP68 3000K

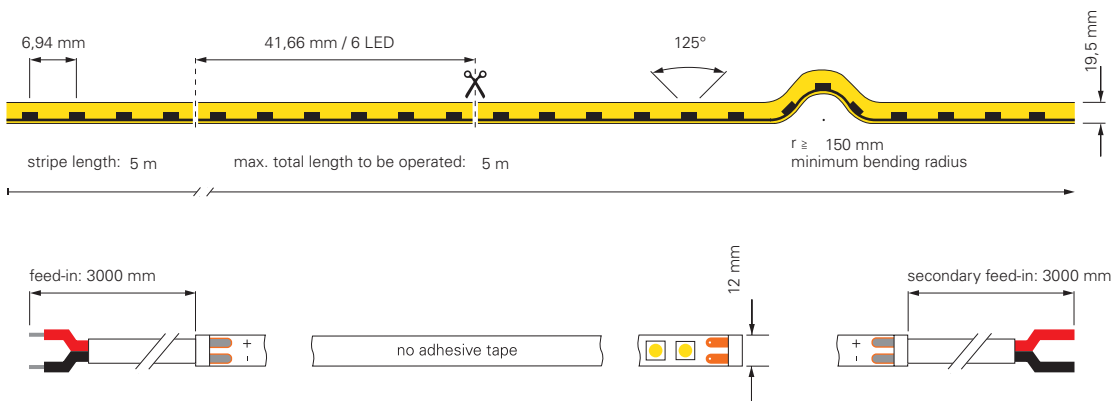

item	colour	temperature	efficiency	light current	dimensions L	power	light source	price
840287	ww	3000K	36 lm/W	368 lm/m	5000 mm	10,5 W/m	144 LED/m	799,95 €



incl. accessories: 10x retaining clip, 10x screw, 2x endcap

930447	profile for D Flex Line SIDE aluminium anodized L x W x H: 1000 x 15 x 21 mm	14,95 €
930451	Flex profile for D Flex Line Side aluminium L x W x H: 500 x 15 x 20 mm	26,95 €
930532	assembly set for D Flex Line 12 x 20 mm	9,95 €
930593	gel glue for gluing the end caps 3g	5,95 €

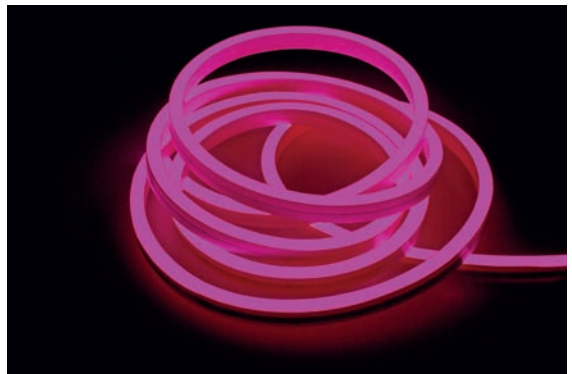
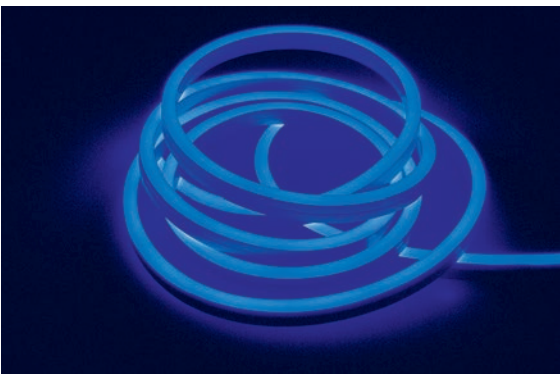
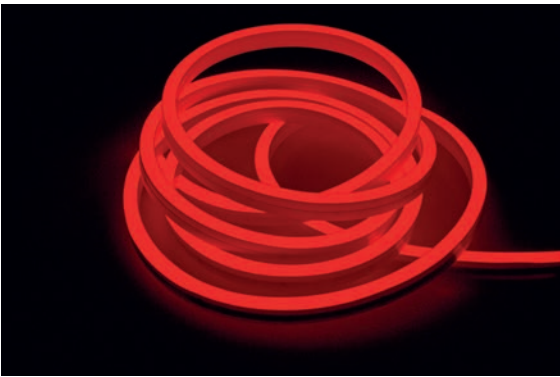
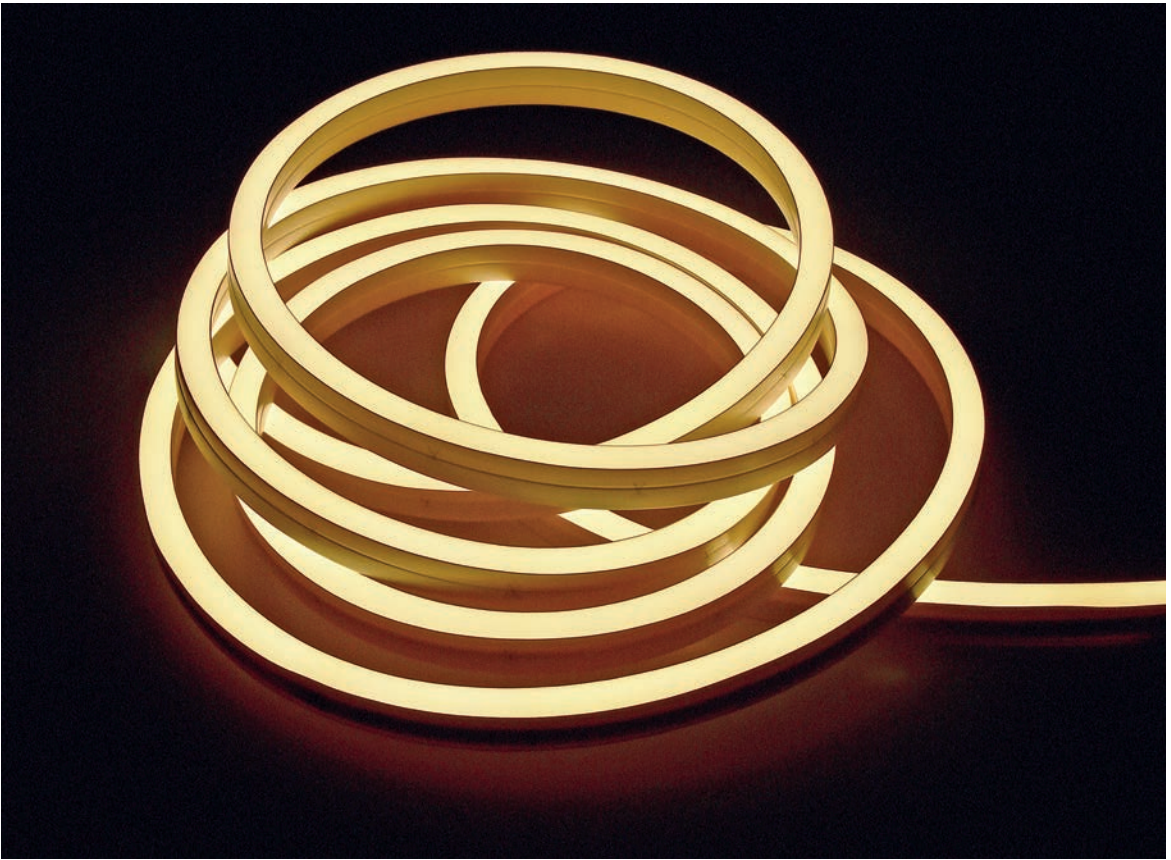



D FLEX LINE SIDE VIEW IP68 RGBW

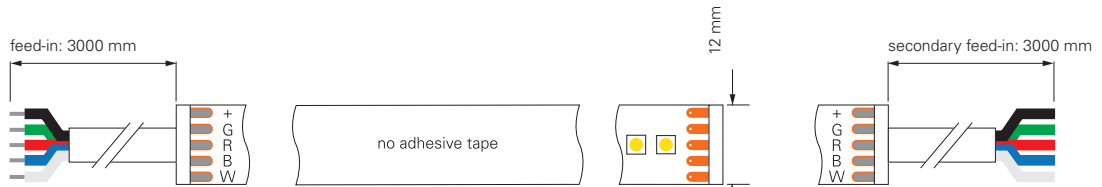
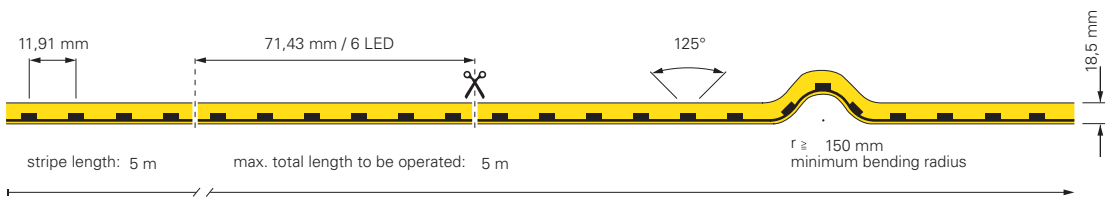

item	colour temperature	efficiency	light current	dimensions L	power	light source	price
840290	470-630 nm	20 lm/W	210 lm/m	5000 mm	10,5 W/m	84 LED/m	799,95 €

CV						
----	--	--	--	--	--	--

incl. accessories: 10x retaining clip, 10x screw, 2x endcap

930447	profile for D Flex Line SIDE aluminium anodized L x W x H: 1000 x 15 x 21 mm	14,95 €
930451	Flex profile for D Flex Line Side aluminium L x W x H: 500 x 15 x 20 mm	26,95 €
930532	assembly set for D Flex Line 12 x 20 mm	9,95 €
930593	gel glue for gluing the end caps 3g	5,95 €

230V | 1CH

This LED stripe is ideally suited if the requirements and focus are on flexible, water-protected and long-lasting lighting routes in indoor and outdoor areas.

Due to the voltage of 230V, no additional power supply unit is required. The delivery is ready for connection with mounted Schuko plug and moulded endcap.

The LED stripe can be dimmed from 100% to 40% by a phase on/phase off dimmer to suit the requirement or ambient lighting.

Applications of large distances, such as on buildings or hotel corridors can be operated in one piece up to 50m.





2835-84-230V-2700K-15M / 2700K-50M / 3000K-15M / 3000K-50M / 4000K-15M / 4000K-50M PVC-EXTRUSION

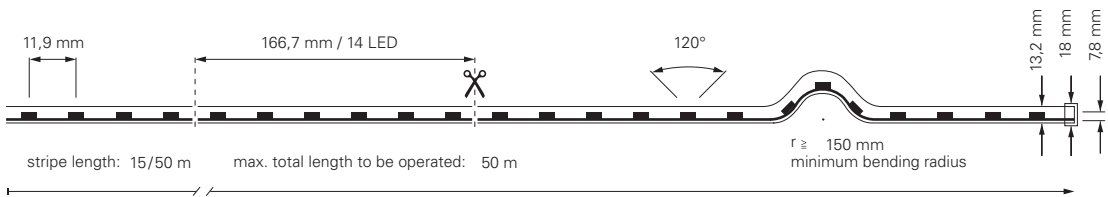

item	colour temperature	efficiency	light current	dimensions L	power	light source	price
840390	ww 2700K	103 lm/W	1442 lm/m	15000 mm	14 W/m	84 LED/m	769,95 €
840391	ww 2700K	103 lm/W	1442 lm/m	50000 mm	14 W/m	84 LED/m	2.499,95 €
840386	ww 3000K	105 lm/W	1470 lm/m	15000 mm	14 W/m	84 LED/m	769,95 €
840387	ww 3000K	105 lm/W	1470 lm/m	50000 mm	14 W/m	84 LED/m	2.499,95 €
840388	nw 4000K	114 lm/W	1596 lm/m	15000 mm	14 W/m	84 LED/m	769,95 €
840389	nw 4000K	114 lm/W	1596 lm/m	50000 mm	14 W/m	84 LED/m	2.499,95 €

230 Volt

SMD 2835

Ra 80

1 CH

IP65

-20°C +40°C

840390, 840386, 840388 incl. 30 brackets with screws and dowels
840391, 840387, 840389 incl. 100 brackets with screws and dowels

930689	end caps set 2 pieces	4,95 €
930690	feed-in cable 300cm with IP44 contour plug	34,95 €
930691	flexible-connector 60cm	24,95 €
930692	mounting clamps set 10 pieces	9,95 €
930693	plastic mounting profile 100cm	14,95 €
930593	gel glue for gluing the end caps 3g	5,95 €



POWER SUPPLIES

- 688 power supplies | overview
- 690 technical information
- 692 DC | CV | quick finder
- 696 DC | CV
- 708 DC | CC | quick finder
- 710 DC | CC
- 722 DC | CC/CV
- 724 AC | CV | quick finder
- 725 AC | CV
- 727 gear units for metal vapour lamps



DC | CV
not dimmable
from page 696



DC | CV
not dimmable | IP
from page 698



DC | CV
dimmable via phase
control or phase cut-off
from page 700



DC | CV
dimmable via 1-10V
from page 702



DC | CV |
dimmable via DALI /
DALI+ 1-10V / Touch-Dim
from page 704



DC | CV
dimmable via KNX
page 706



DC | CV
dimmable via CASAMBI
page 706



DC | CV
dimmable via DMX
page 707



DC | CC
not dimmable
from page 711



DC | CC
dimmable via
phase cut-off
from page 714



DC | CC
dimmable via phase
control or phase cut-off
page 717



DC | CC
dimmable via DALI /
DALI + Intelli-Touch-Dim
from page 718



DC | CC
dimmable via KNX
page 721



DC | CC
dimmable via CASAMBI
page 722



DC | CC/CV
dimmable via phase
control or Touch-Dim
page 723



AC | CV
dimmable via phase
control or phase cut-off
page 725



AC | CV | dimmable via
leading edge
page 726



gear units for
metal vapour lamps
page 727



power supplies



PLANNING ELECTRICAL INSTALLATIONS EVEN BETTER

You will certainly notice the new technical data when browsing through our power supplies and ask yourself what it is all about? In future, we would like to support you even better in the planning and dimensioning of your installations. The background to this is that more and more power supplies for lighting are already being installed in standard buildings [directly in the luminaires or as an external power supply].

Due to the inrush currents inherent in the design, e.g. after a power failure and the subsequent simultaneous start of all power supplies, an overload of the circuit breakers may occur. In order to be able to take this into account during the planning stage, we provide you with the necessary data for all our power supplies.

INRUSH CURRENT

In future, you will find the specification of the maximum inrush current directly with our power supply units. The maximum current value [amperes/A], is specified in connection with the respective time [microseconds/ μ s] and defines when exactly the highest current consumption occurs after the mains voltage is applied. You will find this limit value again with many manufacturers in the data sheets of corresponding components, as this can lead to an overload/damage.

DEKO-LIGHT POWER SUPPLIES | DESIGN FLAT

- plastic housing
- suitable for indoor use
- flicker free
- short-circuit proof and overload protection
- overheat control

872629	12V	6W	0-500mA	7A/300 μ s	98 x 46 x 11 mm	18,95 €
862231	12V	12W	0-1000mA	8A/300 μ s	128 x 50 x 13 mm	22,95 €
862232	12V	20W	0-1670mA	12A/300 μ s	128 x 50 x 14 mm	26,95 €
862121	12V	50W	0-4160mA	15A/300 μ s	185 x 62 x 22 mm	59,95 €

HOW MANY POWER SUPPLY UNITS PER CIRCUIT BREAKER?

The maximum number of power supply units that may be connected to the respective circuit breaker is directly dependent on the inrush current. In our quick finders you will find the number for the most common types of circuit breaker [B10A, B16A, C10A, C16A].

CAPACITIVE LOAD OF POWER SUPPLIES

Due to their design, power supplies sometimes represent very different capacitive loads. Especially in combination with motion detectors, twilight switches or switching/dimming actuators, this value [as with the capacitor in nF/pF], which is available for many power supplies and specified in our quick finders, plays an important role with regard to the suitability and durability of all components. Please also refer to the manufacturer's data sheets.

electr. data		dimmable via						usage / design		electrical limit values		power supply			
voltage	power	leading edge / cut-off	1 - 10V	touch dimmer [push]	DMX	DALI	KNX	CASAMBI-App	indoor	outdoor	design	capacitive load	max. quantity per automatic circuit breaker	item number	page
12V	2,5-25 W	x							x		basic	31.16nF	B10=35, B16=56, C10=35, C16=56	862240	701
12V	40 W								x		basic	251.7nF	B10A=11, B16A=18, C10A=24, C16A=39	862162	698

WIRE CROSS SECTION

When installing voltage-stable [CV] or current-stable [CC] power supply units and associated components, always ensure that the cable cross-sections are sufficiently dimensioned, especially with regard to the dependence of the cable length.

12 V	2 m	5 m	10 m	12 m
25 W	0,25	0,75	1,50	[2,50]
50 W	0,75	1,50	4,00	[4,00]
75 W	1,00	2,50	4,00	[6,00]
100 W	1,50	4,00	6,00	[10,00]
125 W	1,50	4,00	10,00	[10,00]
150 W	2,50	6,00	10,00	-
200 W	2,50	6,00	-	-
300 W	4,00	10,00	-	-
400 W	6,00	-	-	-

The specified cable cross-sections [mm²] were adapted to the commercially available cross-sections. The maximum cable length of 10 m should not be exceeded. »Red values« must be avoided urgently.

24 V	2 m	5 m	10 m	12 m
25 W	0,25	0,25	0,50	[0,50]
50 W	0,25	0,50	0,75	[1,00]
75 W	0,25	0,75	1,00	[1,50]
100 W	0,50	0,75	1,50	[2,50]
125 W	0,50	1,00	2,50	[2,50]
150 W	0,50	1,50	2,50	[4,00]
200 W	0,75	1,50	4,00	[4,00]
300 W	1,00	2,50	6,00	-
400 W	1,50	4,00	6,00	-

48 V	2 m	5 m	10 m	12 m
25 W	0,25	0,25	0,25	[0,25]
50 W	0,25	0,25	0,25	[0,25]
75 W	0,25	0,25	0,50	[0,50]
100 W	0,25	0,25	0,50	[0,50]
125 W	0,25	0,25	0,50	[0,75]
150 W	0,25	0,50	0,75	[0,75]
200 W	0,25	0,50	1,00	[1,00]
300 W	0,25	0,75	1,50	[1,50]
400 W	0,50	1,00	2,50	[2,50]

DO YOU ALREADY KNOW OUR LONG-FLAT POWER SUPPLIES?

These power supplies have a lot of power up to 150 watts of concentrated power with a cross-section of just 30 x 22 mm! This power supply unit therefore fits in almost all ceiling coves, shadow gaps or in all other installation situations with little space.



electr. data		dimmable via								usage / design			electrical limit values		power supply	
voltage	power	leading edge / cut-off	1 - 10V	touch dimmer [push]	DMX	DALI	KNX	CASAMBI-App	indoor	outdoor	design	capacitive load	max. quantity per automatic circuit breaker	item number	page	
		x	x	x	x	x	x	x	x	x	x					
12V	4 W								x	x	mini		B10A=17, B16A=28, C10A=37, C16A=59	872127	696	
12V	6 W								x		flat	38.83nF	B10A=17, B16A=28, C10A=37, C16A=59	872629	697	
12V	12 W								x	x	octo	101uF	B10A=17, B16A=27, C10A=36, C16A=58	862229	696	
12V	12 W								x		flat		B10A=17, B16A=28, C10A=37, C16A=59	872632	697	
12V	20 W								x		flat	938uF	B10A=17, B16A=27, C10A=36, C16A=58	862232	697	
12V	2,5-25 W	x							x		basic	31.16nF	B10=35, B16=56, C10=35, C16=56	862240	701	
12V	40 W								x		basic	251.7nF	B10A=11, B16A=18, C10A=24, C16A=39	862162	698	
12V	40 W								x	x	IP	621.5nF	B10A=5, B16A=9, C10A=12, C16A=19	872082	698	
12V	40 W								x	x	IP		B10A=6, B16A=9, C10A=10, C16A=16	872097	699	
12V	40 W		x	x		x			x		basic		B10A=18, B16A=28, C10A=36, C16A=56	862253	704	
12V	45 W								x		long-flat	462.1nF	B10A=5, B16A=9, C10A=12, C16A=19	862123	697	
12V	50 W								x		flat	485.5nF	B10A=11, B16A=18, C10A=24, C16A=39	862121	697	
12V	12-50 W	x							x		basic	1924uF	B10A=17, B16A=28, C10A=17, C16A=28	862220	701	
12V	60 W								x		long-flat	462.1nF	B10A=5, B16A=9, C10A=12, C16A=19	862093	697	
12V	60 W								x	x	IP		B10A=6, B16A=9, C10A=10, C16A=16	872098	699	
12V	60 W						x		x	x	IP		B10A=6, B16A=9, C10A=10, C16A=16	872109	706	
12V	60 W							x	x		basic		B10A=6, B16A=9, C10A=10, C16A=16	862249	706	
12V	75 W								x		basic	870nF	B10A=11, B16A=18, C10A=24, C16A=39	862127	698	
12V	75 W								x	x	IP	621.5nF	B10A=5, B16A=8, C10A=10, C16A=16	872084	698	
12V	75 W		x	x		x			x		basic		B10A=10, B16A=16, C10A=20, C16A=32	862254	704	
12V	90 W								x	x	IP		B10A=2, B16A=3, C10A=3, C16A=6	872099	699	
12V	100 W								x		basic	842.2nF	B10A=3, B16A=5, C10A=7, C16A=11	862165	698	
12V	100 W								x	x	IP	621.5nF	B10A=3, B16A=5, C10A=7, C16A=11	872093	698	
12V	100 W								x		long-flat	462.1nF	B10A=3, B16A=5, C10A=7, C16A=11	862125	697	
12V	33-100 W	x							x	x	IP	93,14nF	B10=7, B16=15, C10=7, C16=15	872135	701	
12V	34-100 W	x							x		basic	146,34nF	B10=7, B16=15, C10=7, C16=15	862241	701	

electr. data		dimmable via							usage / design			electrical limit values		power supply	
voltage	power	leading edge / cut-off		touch dimmer [push]	DIMX	DALI	KNX	CASAMBI-App	indoor	outdoor	design	capacitive load	max. quantity per automatic circuit breaker	item number	page
		1 - 10V													
12V	120 W								x	x	IP		B10A=2, B16A=4, C10A=4, C16A=6	872100	699
12V	120 W						x		x		IP		B10A=2, B16A=4, C10A=4, C16A=6	872110	706
12V	120 W							x	x		IP		B10A=2, B16A=4, C10A=4, C16A=6	862250	706
12V	135 W				x				x		*		B10A=7, B16A=12, C10A=16, C16A=25	843274	707
12V	150 W								x		long-flat	462.1nF	B10A=3, B16A=5, C10A=6, C16A=10	862172	697
12V	150 W								x		basic	591.2nF	B10A=2, B16A=4, C10A=6, C16A=9	862167	698
12V	150 W								x	x	IP	621.5nF	B10A=2, B16A=4, C10A=6, C16A=9	872086	698
12V	150 W		x						x	x	IP		B10A=3, B16A=5, C10A=6, C16A=10	872011	702
12V	200 W		x	x		x			x		basic		B10A=3, B16A=5, C10A=5, C16A=9	862160	703
12V	66-200 W	x							x	x	IP	148,64nF	B10=3, B16=7, C10=3, C16=7	872137	701
12V	200 W								x	x	IP	621.5nF	B10A=2, B16A=3, C10A=4, C16A=7	872088	698
12V	200 W						x		x		IP		B10A=2, B16A=4, C10A=4, C16A=6	872111	706
24V	4 W								x	x	mini		B10A=59, B16A=94, C10A=123, C16A=197	872128	696
24V	6 W								x		flat	43.5nF	B10A=17, B16A=28, C10A=37, C16A=59	872630	697
24V	12 W								x	x	octo	620uF	B10A=17, B16A=27, C10A=36, C16A=58	862230	696
24V	12 W								x		flat	311uF	B10A=17, B16A=27, C10A=36, C16A=58	862233	697
24V	20 W								x		flat	446uF	B10A=17, B16A=27, C10A=36, C16A=58	862234	697
24V	2,5-25 W	x							x		basic	9520uF	B10=35, B16=56, C10=35, C16=56	862221	701
24V	40 W								x		basic	762nF	B10A=11, B16A=18, C10A=24, C16A=39	862163	698
24V	40 W								x	x	IP	626.3nF	B10A=5, B16A=9, C10A=12, C16A=19	872083	698
24V	40 W								x	x	IP		B10A=6, B16A=9, C10A=10, C16A=16	872101	699
24V	40 W		x	x		x			x		basic		B10A=18, B16A=28, C10A=36, C16A=56	862255	704
24V	45 W								x		long-flat	451.2nF	B10A=5, B16A=9, C10A=12, C16A=19	862124	697
24V	12-50 W	x							x		basic	10520uF	B10A=17, B16A=28, C10A=17, C16A=28	862222	701
24V	50 W								x		flat	604.5nF	B10A=11, B16A=18, C10A=24, C16A=39	862122	697
24V	60 W		x						x		*		B10A=10, B16A=16, C10A=10, C16A=16	872817	702

electr. data		dimmable via							usage / design			electrical limit values		power supply	
voltage	power	leading edge / cut-off	1 - 10V	touch dimmer [push]	DMX	DALI	KNX	CASAMBI-App	indoor	outdoor	design	capacitive load	max. quantity per automatic circuit breaker	item number	page
		x	x	x	x	x	x	x	x	x	x				
24V	60 W								x		long-flat	451.2nF	B10A=5, B16A=9, C10A=12, C16A=19	862094	697
24V	60 W								x	x	IP		B10A=6, B16A=9, C10A=10, C16A=16	872102	699
24V	60 W						x		x		IP		B10A=6, B16A=9, C10A=10, C16A=16	872112	706
24V	12-60 W	x							x	x	*			872045	700
24V	60 W							x	x		basic		B10A=6, B16A=9, C10A=10, C16A=16	862251	706
24V	75 W								x		basic	760nF	B10A=11, B16A=18, C10A=24, C16A=39	862164	698
24V	75 W								x	x	IP	626.3nF	B10A=5, B16A=8, C10A=10, C16A=16	872085	698
24V	75 W		x	x		x			x		basic		B10A=10, B16A=16, C10A=20, C16A=32	862256	704
24V	90 W								x	x	IP		B10A=2, B16A=3, C10A=3, C16A=6	872103	699
24V	100 W								x		basic	724.2nF	B10A=3, B16A=5, C10A=7, C16A=11	862166	698
24V	33-100 W	x							x		IP	94,13nF	B10=7, B16=15, C10=7, C16=15	872136	701
24V	34-100 W	x							x		basic	140.74nF	B10=7, B16=15, C10=7, C16=15	862242	701
24V	100 W								x		long-flat	451.2nF	B10A=3, B16A=5, C10A=7, C16A=11	862126	703
24V	100 W								x	x	IP	626.3nF	B10A=3, B16A=5, C10A=7, C16A=11	872094	698
24V	120 W								x	x	IP		B10A=2, B16A=4, C10A=4, C16A=6	872104	699
24V	120 W						x		x	x	IP		B10A=2, B16A=4, C10A=4, C16A=6	872113	706
24V	120 W							x	x		basic		B10A=2, B16A=4, C10A=4, C16A=6	862252	706
24V	135 W				x				x		*		B10A=7, B16A=12, C10A=16, C16A=25	843275	707
24V	150 W								x		basic	591.2nF	B10A=2, B16A=4, C10A=6, C16A=9	862168	698
24V	150 W								x		long-flat	451.2nF	B10A=3, B16A=5, C10A=6, C16A=10	862173	697
24V	150 W								x	x	IP	626.3nF	B10A=2, B16A=4, C10A=6, C16A=9	872087	698
24V	30-150 W	x							x	x	*			872046	700
24V	200 W		x	x		x			x		basic		B10A=4, B16A=6, C10A=7, C16A=12	862161	703
24V	200 W						x		x		IP		B10A=2, B16A=4, C10A=4, C16A=6	872114	706
24V	66-200 W	x							x	x	IP	148.64nF	B10=3, B16=7, C10=3, C16=7	872138	701
24V	240 W								x	x	IP	626.3nF	B10A=2, B16A=3, C10A=4, C16A=7	872089	698

electr. data		dimmable via							usage / design			electrical limit values		power supply	
voltage	power	leading edge / cut-off		touch dimmer [push]	DMX	DALI	KNX	CASAMBI+App	indoor	outdoor	design	capacitive load	max. quantity per automatic circuit breaker	item number	page
		1 - 10V													
24V	320 W								x	x	IP	626.3nF	B10A=2, B16A=3, C10A=4, C16A=6	872091	698
48V	40 W								x	x	IP		B10A=6, B16A=9, C10A=10, C16A=16	872105	699
48V	60 W								x	x	IP		B10A=6, B16A=9, C10A=10, C16A=16	872106	699
48V	75 W								x	x	IP		B10A=4, B16A=7, C10A=7, C16A=11	872116	699
48V	75 W		x						x	x	IP		B10A=4, B16A=7, C10A=7, C16A=11	872117	703
48V	75 W					x			x	x	IP		B10A=4, B16A=7, C10A=7, C16A=11	872118	705
48V	90 W								x	x	IP		B10A=2, B16A=3, C10A=3, C16A=6	872107	699
48V	120 W								x	x	IP		B10A=2, B16A=4, C10A=4, C16A=6	872108	699
48V	150 W								x	x	IP		B10A=2, B16A=3, C10A=3, C16A=5	872119	699
48V	150 W		x						x	x	IP		B10A=2, B16A=3, C10A=3, C16A=5	872120	703
48V	150 W					x			x	x	IP		B10A=2, B16A=3, C10A=3, C16A=5	872121	705
48V	200 W						x		x		IP		B10A=2, B16A=4, C10A=4, C16A=6	872115	706
48V	240 W								x	x	IP		B10A=2, B16A=4, C10A=4, C16A=6	872122	699
48V	240 W		x						x	x	IP		B10A=2, B16A=4, C10A=4, C16A=6	872123	703
48V	240 W					x			x	x	IP		B10A=2, B16A=4, C10A=4, C16A=6	872124	705
48V	600 W								x	x	IP		B10A=1, B16A=1, C10A=1, C16A=2	872125	699

power supplies design



mini



round / octo



flat



basic



long-flat



IP

* special design

POWER SUPPLIES

DC | CV

not dimmable

DEKO-LIGHT POWER SUPPLIES | DESIGN MINI

- plastic housing
- suitable for indoor and outdoor use
- flicker free
- short-circuit proof and overload protection



item	colour	voltage	power	electricity	max. inrush current	dimensions L x W x H	price
872127	■ black	12V	4W	0-330mA	5A/260µs	38 x 27 x 21 mm	13,95 €
872128	■ black	24V	4W	0-170 mA	5A/260µs	38 x 27 x 21 mm	13,95 €



DEKO-LIGHT POWER SUPPLIES | DESIGN OCTO

- plastic housing
- suitable for indoor and outdoor use
- flicker free
- short-circuit proof and overload protection



item	colour	voltage	power	electricity	max. inrush current	dimensions L x W x H	price
862229	■ black	12V	12W	0-1000mA	15A/200µs	50 x 48 x 24 mm	24,95 € NEW
862230	■ black	24V	12W	0-500mA	15A/200µs	50 x 48 x 24 mm	24,95 € NEW



POWER SUPPLIES

DC | CV
not dimmable

DEKO-LIGHT POWER SUPPLIES | DESIGN FLAT

- plastic housing
- suitable for indoor use
- ideal for concealed mounting in ceiling coving
- flicker free
- short-circuit proof and overload protection
- overheat control



design example

item	colour	voltage	power	electricity	max. inrush current	dimensions L x W x H	price
872629	■ black	12V	6W	0-500mA	7A/300µs	98 x 46 x 11 mm	18,95 €
872632	■ black	12V	12W	0-1000mA	8A/300µs	128 x 50 x 13 mm	22,95 €
862232	■ black	12V	20W	0-1670mA	20A/100µs	128 x 50 x 13 mm	26,95 € NEW
862121	■ black	12V	50W	0-4160mA	15A/300µs	185 x 62 x 22 mm	59,95 €
872630	■ black	24V	6W	0-250mA	7A/300µs	98 x 46 x 11 mm	18,95 €
862233	■ black	24V	12W	0-500mA	15A/200µs	128 x 50 x 13 mm	22,95 € NEW
862234	■ black	24V	20W	0-830mA	20A/100µs	128 x 50 x 13 mm	26,95 € NEW
862122	■ black	24V	50W	0-2100mA	15A/300µs	185 x 62 x 22 mm	59,95 €



design example

DEKO-LIGHT POWER SUPPLIES | DESIGN LONG-FLAT

- plastic housing
- suitable for indoor use
- ideal for concealed mounting in ceiling coving
- flicker free
- short-circuit proof and overload protection
- overheat control

item	colour	voltage	power	electricity	max. inrush current	dimensions L x W x H	price
862123	■ black	12V	45W	0-3750mA	30A/300µs	251 x 30 x 16 mm	55,95 €
862093	□ white	12V	60W	0-5000mA	30A/300µs	305 x 30 x 17 mm	69,95 €
862125	■ black	12V	100W	0-8340mA	50A/300µs	312 x 30 x 18 mm	109,95 €
862172	■ black	12V	150W	0-12500mA	60A/300µs	335 x 30 x 22 mm	149,95 €
862124	■ black	24V	45W	0-1870mA	30A/300µs	251 x 30 x 16 mm	55,95 €
862094	■ black	24V	60W	0-2500mA	30A/300µs	305 x 30 x 17 mm	69,95 €
862126	■ black	24V	100W	0-4170mA	50A/300µs	312 x 30 x 18 mm	109,95 €
862173	■ black	24V	150W	0-6250mA	60A/300µs	335 x 30 x 22 mm	149,95 €



POWER SUPPLIES

DC | CV

not dimmable

DEKO-LIGHT POWER SUPPLIES | DESIGN BASIC

- plastic housing
- suitable for indoor use
- flicker free
- short-circuit proof and overload protection
- overheat control



design example

item	colour	voltage	power	electricity	max. inrush current	dimensions L x W x H	price
862162	■ black	12V	40W	0-3000 mA	15A/300µs	166 x 52 x 24 mm	54,95 €
862127	■ black	12V	75W	0-6300 mA	15A/300µs	184 x 61 x 32 mm	82,95 €
862165	■ black	12V	100W	0-8300 mA	50A/300µs	184 x 61 x 32 mm	104,95 €
862167	■ black	12V	150W	0-12500 mA	60A/300µs	210 x 67 x 34 mm	144,95 €
862163	■ black	24V	40W	0-1700 mA	15A/300µs	166 x 52 x 24 mm	54,95 €
862164	■ black	24V	75W	0-3100 mA	15A/300µs	184 x 61 x 32 mm	82,95 €
862166	■ black	24V	100W	0-4200 mA	50A/300µs	184 x 61 x 32 mm	104,95 €
862168	■ black	24V	150W	0-6250 mA	60A/300µs	210 x 67 x 34 mm	144,95 €



DEKO-LIGHT POWER SUPPLIES | DESIGN IP

- aluminium housing
- suitable for indoor and outdoor use
- flicker free
- short-circuit proof and overload protection
- overheat control



design example

item	colour	voltage	power	electricity	max. inrush current	dimensions L x W x H	price
872082	■ anthrazit	12V	40W	0-3340 mA	30A/300µs	182 x 58 x 30,5 mm	79,95 €
872084	■ anthrazit	12V	75W	0-6250 mA	35A/300µs	186 x 64 x 39 mm	99,95 €
872093	■ anthrazit	12V	100W	0-8340 mA	50A/300µs	186 x 64 x 39 mm	119,95 €
872086	■ anthrazit	12V	150W	0-12500 mA	60A/300µs	191 x 70 x 40 mm	164,95 €
872088	■ anthrazit	12V	200W	0-16600 mA	75A/300µs	249 x 72 x 41 mm	184,95 €
872083	■ anthrazit	24V	40W	0-1670 mA	30A/300µs	182 x 58 x 30,5 mm	79,95 €
872085	■ anthrazit	24V	75W	0-3125 mA	35A/300µs	199 x 67 x 35 mm	99,95 €
872094	■ anthrazit	24V	100W	0-4170 mA	50A/300µs	186 x 64 x 39 mm	119,95 €
872087	■ anthrazit	24V	150W	0-6250 mA	60A/300µs	191 x 70 x 40 mm	164,95 €
872089	■ anthrazit	24V	240W	0-10000 mA	75A/300µs	249 x 72 x 41 mm	194,95 €
872091	■ anthrazit	24V	320W	0-13340 mA	85A/300µs	252 x 90 x 44 mm	239,95 €



POWER SUPPLIES

DC | CV

not dimmable

MEANWELL POWER SUPPLIES NPF-SERIES

- plastic housing
- suitable for indoor and outdoor use
- flicker free
- short-circuit proof and overload protection
- overheat control



design example

item	colour	voltage	power	electricity	max. inrush current	dimensions L x W x H	price
872097	■ black	12V	40W	0-3340mA	50A/270µs	150 x 53 x 35 mm	84,95 €
872098	■ black	12V	60W	0-5000mA	50A/270µs	150 x 53 x 35 mm	94,95 €
872099	■ black	12V	90W	0-7500mA	60A/550µs	171 x 63 x 38 mm	119,95 €
872100	■ black	12V	120W	0-10000mA	60A/520µs	191 x 63 x 38 mm	139,95 €
872101	■ black	24V	40W	0-1670mA	50A/270µs	150 x 53 x 35 mm	84,95 €
872102	■ black	24V	60W	0-2500mA	50A/270µs	150 x 53 x 35 mm	94,95 €
872103	■ black	24V	90W	0-3750mA	60A/550µs	171 x 63 x 38 mm	119,95 €
872104	■ black	24V	120W	0-5000mA	60A/520µs	191 x 63 x 38 mm	139,95 €
872105	■ black	48V	40W	0-840mA	50A/270µs	150 x 53 x 35 mm	84,95 €
872106	■ black	48V	60W	0-1250mA	50A/270µs	150 x 53 x 35 mm	94,95 €
872107	■ black	48V	90W	0-1880mA	60A/550µs	171 x 63 x 38 mm	119,95 €
872108	■ black	48V	120W	0-2500mA	60A/520µs	191 x 63 x 38 mm	139,95 €



MEANWELL POWER SUPPLIES ELG/HLG-SERIES

- aluminium housing
- suitable for indoor and outdoor use
- flicker free
- short-circuit proof and overload protection
- overheat control
- output voltage/current adjustable via int. potentiometers



design example

item	colour	voltage	power	electricity	max. inrush current	dimensions L x W x H	price	
872116	□ silver coloured	ELG	48V	75W	0-1600mA	50A/350µs	180 x 63 x 36 mm	99,95 €
872119	□ silver coloured	ELG	48V	150W	0-3130mA	65A/550µs	219 x 63 x 36 mm	169,95 €
872122	□ silver coloured	ELG	48V	240W	0-5000mA	60A/510µs	244 x 71 x 38 mm	199,95 €
872125	□ silver coloured	HLG	48V	600W	0-12500mA	70A/1000µs	280 x 144 x 49 mm	489,95 €





ABN SAFETY ISOLATING TRANSFORMER [DC] ACCORDING TO DIN 2006-7 EN 61558-2-6: 2010-04 PRIMARY DIMMABLE

A safety transformer requires stronger or double insulation and stricter checks apply. It is therefore suitable for applications

according to DIN EN 61558 in the area of increased personal protection, e. g. for the operation of luminaires which are installed in swimming pools, fountains, wet cells or similar.



design example

LED SAFETY ISOLATING TRANSFORMER

- dimmable via leading edge
- maximum load: 80% continuous operation
- suitable for indoor and outdoor use

item	colour	voltage	power	dimensions L x W x H	price
872045	■ black	24V	12 - 60W	150 x 90 x 70 mm	329,95 €
872046	■ black	24V	30 - 150W	176 x 116 x 110 mm	449,95 €



POWER SUPPLIES

DC | CV
dimmissible

DEKO-LIGHT POWER SUPPLIES | DESIGN BASIC PRIMARY DIMMABLE

- plastic housing
- suitable for indoor use
- ideal for upgrade existing installations, as primarily with commercially available rotary / touch dimmers [C-capable, via phase angle or section] dimmable
- cannot be combined with PWM dimmers such as RF, DMX, DALI or KNX
- flicker free
- short-circuit proof and overload protection
- overheat control



design example

item	colour	voltage	power	max. inrush current	dimensions L x W x H	price
862240	■ black	12V	2,5 - 25W	10A/100µs	122 x 52 x 30 mm	64,95 € NEW
862220	■ black	12V	12,0 - 50W	20A/100µs	184 x 61 x 33 mm	84,95 € NEW
862241	■ black	12V	34,0 - 100W	45A/100µs	210 x 67 x 34 mm	164,95 € NEW
862221	■ black	24V	2,5 - 25W	10A/100µs	122 x 52 x 30 mm	64,95 € NEW
862222	■ black	24V	12,0 - 50W	20A/100µs	184 x 61 x 33 mm	84,95 € NEW
862242	■ black	24V	34,0 - 100W	45A/100µs	210 x 67 x 34 mm	164,95 € NEW



DEKO-LIGHT POWER SUPPLIES | DESIGN IP PRIMARY DIMMABLE

- metal housing
- suitable for indoor and outdoor use
- ideal for upgrade existing installations, as primarily with commercially available rotary / touch dimmers [C-capable, via phase angle or section] dimmable
- cannot be combined with PWM dimmers such as RF, DMX, DALI or KNX
- flicker free
- short-circuit proof and overload protection
- overheat control



design example

item	colour	voltage	power	max. inrush current	dimensions L x W x H	price
872135	□ silver coloured	12V	33 - 100W	45A/100µs	191 x 70 x 40 mm	174,95 € NEW
872137	□ silver coloured	12V	66 - 200W	45A/100µs	249 x 72 x 40 mm	224,95 € NEW
872136	□ silver coloured	24V	33 - 100W	45A/100µs	191 x 70 x 40 mm	174,95 € NEW
872138	□ silver coloured	24V	66 - 200W	45A/100µs	249 x 72 x 40 mm	224,95 € NEW



POWER SUPPLIES

DC | CV
dimmable



DEKO-LIGHT POWER SUPPLIES | DESIGN IP

- aluminium housing
- suitable for indoor and outdoor use
- short-circuit proof and overload protection
- overheat control
- dimmable via 1 - 10V

item	colour	voltage	power	electricity	max. inrush current	dimensions L x W x H	price
872011	<input type="checkbox"/> silver coloured	12V	150W	0-12500mA	60A/300µs	223 x 70 x 40 mm	164,95 €



HEP POWER SUPPLY LAV60W

- metal housing
- suitable for indoor use
- short-circuit proof and overload protection
- overheat control
- dimmable via 1 - 10V

item	colour	voltage	power	electricity	max. inrush current	dimensions L x W x H	price
872817	<input type="checkbox"/> white	24V	60W	0-2500 mA	37,4A/171µs	280 x 30 x 27,5 mm	91,95 €



POWER SUPPLIES

DC | CV
dimmissible



DEKO-LIGHT POWER SUPPLIES | DESIGN BASIC

- aluminium housing
- suitable for indoor use
- short-circuit proof and overload protection
- overheat control
- dimmable via 0-10V / 1-10V, Touch-Dim [Push] or DALI Bus according to IEC 62386

item	colour	voltage	power	electricity	max. inrush current	dimensions L x W x H	price
862160	■ black	12V	200W	0-16700 mA	28A/1250μs	310 x 60 x 45 mm	219,95 €
862161	■ black	24V	200W	0-8300 mA	27A/650μs	310 x 60 x 45 mm	219,95 €



design example

MEANWELL POWER SUPPLIES ELG/HLG-SERIES

- aluminium housing
- suitable for indoor and outdoor use
- flicker free
- short-circuit proof and overload protection
- overheat control
- dimmable via 0-10V / 1-10V

item	colour	voltage	power	electricity	max. inrush current	dimensions L x W x H	price
872117	□ silver coloured	ELG	48V 75W	0-1600mA	50A/350μs	180 x 63 x 36 mm	104,95 €
872120	□ silver coloured	ELG	48V 150W	0-3130mA	65A/550μs	219 x 63 x 36 mm	169,95 €
872123	□ silver coloured	ELG	48V 240W	0-5000mA	60A/510μs	244 x 71 x 38 mm	199,95 €
872126	□ silver coloured	HLG	48V 600W	0-12500mA	70A/1000μs	280 x 144 x 49 mm	499,95 €



POWER SUPPLIES

DC | CV
dimmable

DEKO-LIGHT POWER SUPPLIES LCP DALI

- plastic housing
- suitable for indoor use
- short-circuit proof and overload protection
- overheat control
- dimmable via DALI2 or DALI1, 10V / 1-10V or Touch-Dim via 230V Taster
- new Intelli-Push function [key combination synchronises all connected power supplies]



design example

item	colour	voltage	power	electricity	max. inrush current	dimensions L x W x H	price	
862253	<input type="checkbox"/> white	12V	40W	0-3400mA	10A/32µs	185 x 42,5 x 28,5 mm	99,95 €	NEW
862254	<input type="checkbox"/> white	12V	75W	0-6250mA	22A/300µs	295 x 40 x 32 mm	129,95 €	NEW
862255	<input type="checkbox"/> white	24V	40W	0-1700mA	10A/32µs	185 x 42,5 x 28,5 mm	99,95 €	NEW
862256	<input type="checkbox"/> white	24V	75W	0-3125mA	22A/300µs	295 x 40 x 32 mm	129,95 €	NEW



DEKO-LIGHT POWER SUPPLIES | DESIGN BASIC

- aluminium housing
- suitable for indoor use
- short-circuit proof and overload protection
- overheat control
- dimmable via DALI1, 0-10V, 1-10V or Intelli-Push [Touch-Dim via 230V-Taster]

item	colour	voltage	power	electricity	max. inrush current	dimensions L x W x H	price
862160	<input checked="" type="checkbox"/> black	12V	200W	0-16700 mA	28A/1250µs	310 x 60 x 45 mm	219,95 €
862161	<input checked="" type="checkbox"/> black	24V	200W	0-8300 mA	27A/650µs	310 x 60 x 45 mm	219,95 €



POWER SUPPLIES

DC | CV
dimmable



design example

MEANWELL POWER SUPPLIES ELG-DALI

- aluminium housing
- suitable for indoor and outdoor use
- flicker free
- short-circuit proof and overload protection
- overheat control
- dimmable via DALI1

item	colour	voltage	power	electricity	max. inrush current	dimensions L x W x H	price
872118	<input type="checkbox"/> silver coloured	48V	75W	0-1600mA	50A/350µs	180 x 63 x 36 mm	119,95 €
872121	<input type="checkbox"/> silver coloured	48V	150W	0-3130mA	65A/550µs	219 x 63 x 36 mm	179,95 €
872124	<input type="checkbox"/> silver coloured	48V	240W	0-5000mA	60A/510µs	244 x 71 x 38 mm	199,95 €



POWER SUPPLIES

DC | CV
dimmable

MEANWELL POWER SUPPLIES PWM KNX

- plastic housing
- suitable for indoor use
- flicker free
- short-circuit proof and overload protection
- overheat control
- dimmable via KNX-Bus



design example

item	colour	voltage	power	electricity	max. inrush current	dimensions L x W x H	price
872109	■ black	12V	60W	0-5000mA	50A/270µs	150 x 53 x 35 mm	159,95 €
872110	■ black	12V	120W	0-10000mA	60A/520µs	191 x 63 x 38 mm	209,95 €
872111	■ black	12V	200W	0-16600mA	70A/520µs	195 x 68 x 40 mm	244,95 € NEW
872112	■ black	24V	60W	0-2500mA	50A/270µs	150 x 53 x 35 mm	159,95 €
872113	■ black	24V	120W	0-5000mA	60A/520µs	191 x 63 x 38 mm	209,95 €
872114	■ black	24V	200W	0-8300mA	70A/520µs	195 x 68 x 40 mm	244,95 € NEW
872115	■ black	48V	200W	0-4160mA	70A/520µs	195 x 68 x 40 mm	244,95 € NEW



MEANWELL POWER SUPPLIES PWM CASAMBI

- plastic housing
- suitable for indoor use
- flicker free
- short-circuit proof and overload protection
- overheat control
- dimmable via CASAMBI-App



design example

item	colour	voltage	power	electricity	max. inrush current	dimensions L x W x H	price
862249	■ black	12V	60W	0-5000mA	50A/270µs	150 x 53 x 35 mm	259,95 € NEW
862250	■ black	12V	120W	0-10000mA	60A/520µs	191 x 63 x 38 mm	299,95 € NEW
862251	■ black	24V	60W	0-2500mA	50A/270µs	150 x 53 x 35 mm	259,95 € NEW
862252	■ black	24V	120W	0-5000mA	60A/520µs	191 x 63 x 38 mm	299,95 € NEW



POWER SUPPLIES

DC | CV
dimmable

DEKO-LIGHT POWER SUPPLIES HV DMX 2 IN 1

Easy to install and compact DMX unit. A powerful 3 channel dimmer and a 135 Watt power supply are combined in one housing. This makes installation quick and easy. Controllable with all 3 channel control panels and DMX Controllers.

- aluminium housing
- suitable for indoor use
- short-circuit proof and overload protection
- supported DMX 512
- dimmable from 0 - 100%
- flicker free
- with integrated 3-channel DMX dimmer



item	colour	voltage	power	electricity	max. inrush current	dimensions L x W x H	price
843274	■ black	12V	135W	0-11250 mA	23A/320µs	196 x 75 x 40 mm	194,95 €
843275	■ black	24V	135W	0-5630 mA	23A/320µs	196 x 75 x 40 mm	194,95 €

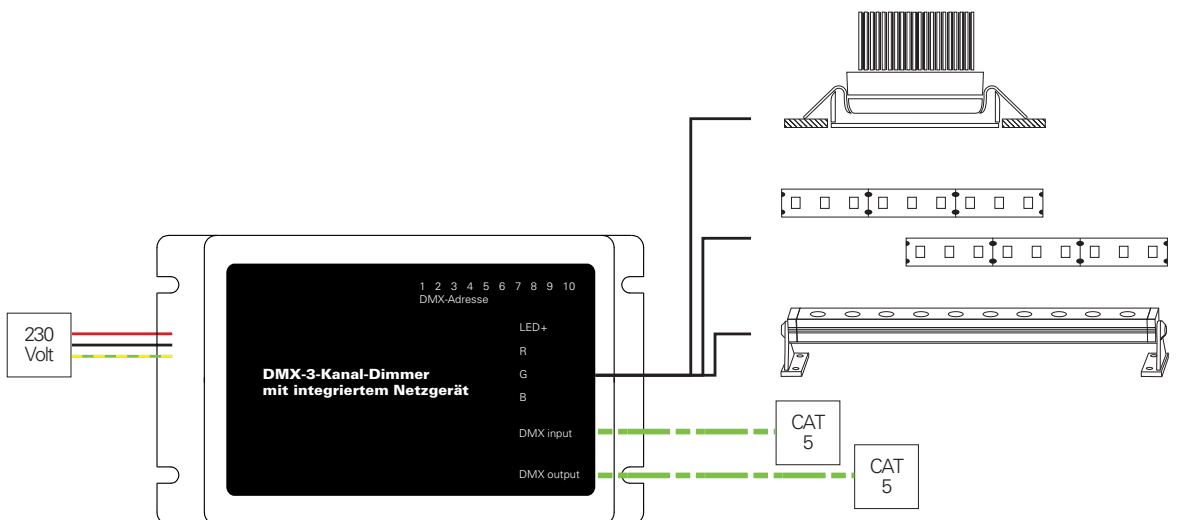

electr. data			dimmable via					usage / design			electrical limit values			power supply	
current strength	power	voltage	leading edge / cut-off	touch dimmer [push]	DALI	KNX	CASAMBI-APP	indoor	outdoor	design	capacitive load	max. quantity per automatic circuit breaker	item number	page	
350 mA	1,1-4,0 W	3-12V						x	x	mini	14.32pF	B10A=17, B16A=28, C10A=37, C16A=59	872026	711	
350 mA	2,1-4,0 W	6-12V	x					x	x	mini	10.00nF	B10A=35, B16A=56, C10A=74, C16A=118	872132	714	
350 mA	0,7-6,0 W	2-18V						x		flat	40.44nF	B10A=17, B16A=28, C10A=37, C16A=59	872628	712	
350 mA	3,2-8,0 W	9-23V						x		round	200uF	B10A=17, B16A=28, C10A=37, C16A=59	862212	711	
350 mA	3,9-9,0 W	11-26V	x					x		basic		B10A=17, B16A=28, C10A=37, C16A=59	862202	715	
350 mA	6,0-10,0 W	17-29V						x		mini		B10A=57, B16A=92, C10A=57, C16A=92	862239	712	
350 mA	6,3-12,0 W	18-35V	x					x		basic	20,65pF	B10A=17, B16A=28, C10A=37, C16A=59	862203	715	
350 mA	0,7-12,0 W	2-35V						x		flat	194,0uF	B10A=11, B16A=18, C10A=24, C16A=39	862223	712	
350 mA	6,3-12,0 W	18-37V	x					x	x	octo	190uF	B10A=35, B16A=56, C10A=74, C16A=118	862235	715	
350 mA	8,8-14,7 W	25-42V	x					x		basic		B10A=29, B16A=47, C10A=29, C16A=47	862142	717	
350 mA	0,7-18,0 W	2-52V						x		basic	147nF	B10A=17, B16A=28, C10A=37, C16A=59	180512	713	
350 mA	9,8-20,0 W	28-57V	x					x		basic		B10A=11, B16A=18, C10A=24, C16A=39	862204	715	
350 mA	0,7-20,0 W	2-57V						x		flat	93.04nF	B10A=11, B16A=18, C10A=24, C16A=39	872634	712	
450 mA	9,9-20,0 W	22-44V	x					x		quick		B10A=11, B16A=18, C10A=24, C16A=39	862257	716	
500 mA	1,0-4,0 W	2-8V						x	x	mini	19.8pF	B10A=17, B16A=28, C10A=37, C16A=59	872065	711	
500 mA	2,0-4,0 W	4-8V	x					x	x	mini	4.75nF	B10A=35, B16A=56, C10A=74, C16A=118	872014	714	
500 mA	1,0-6,0 W	2-12V						x		flat	38.48nF	B10A=17, B16A=28, C10A=37, C16A=59	862130	712	
500 mA	3,0-8,0 W	6-16V						x		round	62.96nF	B10A=11, B16A=18, C10A=24, C16A=39	862128	711	
500 mA	1,0-12,0 W	2-24V						x		flat	298uF	B10A=11, B16A=18, C10A=24, C16A=39	862225	712	
500 mA	6,5-10,0 W	13-20V						x		mini		B10A=57, B16A=92, C10A=57, C16A=92	862238	712	
500 mA	6,0-12,0 W	12-24V	x					x	x	octo	186uF	B10A=35, B16A=56, C10A=74, C16A=118	862236	715	
500 mA	1,0-18,0 W	2-38V						x		basic	147nF	B10A=17, B16A=28, C10A=37, C16A=59	180513	713	
500 mA	1,0-20,0 W	2-40V						x		flat	192.6nF	B10A=11, B16A=18, C10A=24, C16A=39	862132	712	
500 mA	10,0-20,0 W	20-40V	x					x		basic		B10A=11, B16A=18, C10A=24, C16A=39	862205	715	
500 mA	15,0-30,0 W	30-60V						x		basic	366nF	B10A=11, B16A=18, C10A=24, C16A=39	862196	713	
500 mA	20,0-40,0 W	40-80V						x		basic	356nF	B10A=8, B16A=14, C10A=18, C16A=29	862197	713	

electr. data			dimmable via				usage / design			electrical limit values		power supply		
current strength	power	voltage	leading edge / cut-off	touch dimmer (push)	DALI	KNX	CASAMBI-APP	indoor	outdoor	design	capacitive load	max. quantity per automatic circuit breaker	item number	page
500 mA	20,0-40,0 W	40-80V	x					x		basic	29.84nF	B10A=35, B16A=56, C10A=35, C16A=56	862136	715
700 mA	1,7-4,0 W	2-6V						x	x	mini	82pF	B10A=70, B16A=112, C10A=140, C16A=224	872131	711
700 mA	2,0-4,0 W	2,5-6V	x					x	x	mini	10nF	B10A=35, B16A=56, C10A=74, C16A=118	872134	714
700 mA	1,4-6,0 W	2-9V						x		flat	40.44nF	B10A=17, B16A=28, C10A=37, C16A=59	862048	712
700 mA	4,2-8,0 W	6-12V						x		round	46.24nF	B10A=11, B16A=18, C10A=24, C16A=39	862129	711
700 mA	1,4-12,0 W	2-19V						x		flat	190.7nF	B10A=17, B16A=28, C10A=37, C16A=59	862049	712
700 mA	7,0- 12,0 W	10-17V	x					x	x	octo	188uF	B10A=35, B16A=56, C10A=74, C16A=118	862237	715
700 mA	1,4-18,0 W	2-26V						x		basic	147nF	B10A=17, B16A=28, C10A=37, C16A=59	180514	713
700 mA	1,4-20,0 W	2-31V						x		flat	192.6nF	B10A=11, B16A=18, C10A=24, C16A=39	862050	712
700 mA	9,8-20,0 W	14-28V	x					x		basic		B10A=11, B16A=18, C10A=24, C16A=39	862207	715
700 mA	9,1-30,0 W	13-43V						x		basic		B10A=11, B16A=18, C10A=24, C16A=39	862198	713
700 mA	20,3-35,0 W	29-57V						x		basic	359,3nF	B10A=8, B16A=14, C10A=18, C16A=29	862199	713
700 mA	19,6-40,0 W	28-56V	x					x		basic		B10A=35, B16A=56, C10A=35, C16A=56	862208	715
900mA	19,8-40,0 W	22-44V						x		basic	13.5pF	B10A=8, B16A=14, C10A=18, C16A=29	862157	713
1050 mA	9,8-22,0 W	9-20V	x					x		basic	40.72pF	B10A=11, B16A=18, C10A=24, C16A=39	872647	715
1050 mA	9,5-90,0 W	9-28V						x		basic	27.9nF	B10A=35, B16A=56, C10A=35, C16A=56	862133	713
1050 mA	20,0-40,0 W	19-38V						x		basic		B10A=8, B16A=14, C10A=18, C16A=29	862201	713
1050 mA	20,0-40,0 W	19-38V	x					x		basic		B10A=35, B16A=56, C10A=35, C16A=56	862209	715
1050 mA	23,5-45,0 W	22-43V	x					x		basic	33,46nF	B10A=35, B16A=56, C10A=35, C16A=56	862210	715
1050 mA	23,1-45,0 W	22-43V	x					x		quick	33,46nF	B10A=35, B16A=56, C10A=35, C16A=56	862256	704
1300 mA	26,0-50,0 W	20-39V	x					x		basic		B10A=35, B16A=56, C10A=35, C16A=56	862211	715
1400 mA	19,6-40,0 W	14-28V	x					x		basic	20.8nF	B10A=35, B16A=56, C10A=35, C16A=56	862138	715
1500 mA	30,0-60,0 W	20-40V	x					x		quick		B10A=11, B16A=18, C10A=24, C16A=39	862259	716

power supplies design

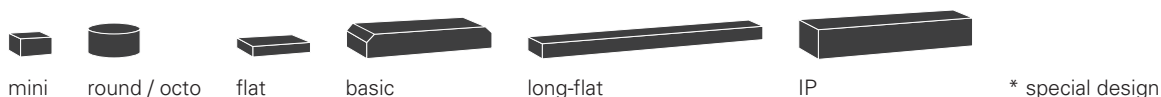

electr. data			dimmable via				usage / design			electrical limit values		power supply	
current strength	power	voltage	leading edge / cut-off	touch dimmer [push]	DALI	KNX	CASAMBI-APP	indoor	outdoor design	capacitive load	max. quantity per automatic circuit breaker	item number	page
MULTI*	3,2-20,0 W	9-40V	x					x	basic		B10A=46, B16A=74, C10A=93, C16A=149	862141	717
MULTI*	3,2-12,0 W	15-54V		x	x			x	basic		B10A=23, B16A=37, C10A=46, C16A=74	862190	719
MULTI*	5,0-25,0 W	20-60V		x	x			x	basic		B10A=23, B16A=37, C10A=46, C16A=74	862191	719
MULTI*	8,75-45,0 W	21-70V		x	x			x	basic		B10A=12, B16A=20, C10A=25, C16A=40	862192	719
MULTI*	14,7-45,0 W	14-43V		x	x			x	basic		B10A=12, B16A=20, C10A=25, C16A=40	862193	719
MULTI*	26,3-75,5 W	25-71V		x	x			x	basic		B10A=3, B16A=5, C10A=6, C16A=10	862194	719
MULTI*	2,1-25,2 W	6-54V		x	x			x	*		B10A=16, B16A=26, C10A=27, C16A=44	862246	720
MULTI*	0,70 - 42,00 W	2-100V		x	x			x	*		B10A=16, B16A=26, C10A=27, C16A=44	862247	720
MULTI*	1,0-60,3 W	2-90V		x	x			x	*		B10A=15, B16A=25, C10A=20, C16A=32	862248	720
MULTI*	2,1-25,2 W	6-54V		x		x		x	*		B10A=16, B16A=26, C10A=27, C16A=44	862174	721
MULTI*	0,7-42,0 W	2-100V		x		x		x	*		B10A=16, B16A=26, C10A=27, C16A=44	862175	721
MULTI*	1,0-60,3 W	2-90V		x		x		x	*		B10A=15, B16A=25, C10A=20, C16A=32	862176	721
MULTI*	2,1-25,2 W	6-54V		x			x	x	*		B10A=16, B16A=26, C10A=27, C16A=44	862243	722
MULTI*	0,7-42,0 W	2-100V		x			x	x	*		B10A=16, B16A=26, C10A=27, C16A=44	862244	722
MULTI*	1,0-60,3 W	2-90V		x			x	x	*		B10A=15, B16A=25, C10A=20, C16A=32	862245	722

* Due to the large number of possible settings, please refer to the detailed technical data on the specified product page.

TIPS AND TRICKS FOR CURRENT-STABLE POWER SUPPLIES

In contrast to voltage-stable power supplies [CV], current-stable power supply units, often abbreviated to CC [constant current], the output current is stable. This important factors that must be taken into focus during planning and installation.

- Do not connect LEDs to CC power supply units below voltage, as this can damage them and cause them to fail after a short period of operation.
- if possible: 1 luminaire = 1 power supply
- if necessary: operate max. 2 luminaires in a series connection on one power supply unit. However, the voltage range and the power of the power supply must be checked carefully.

Netzgerätedaten prüfen! Check driver data!

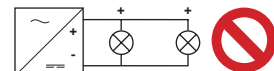
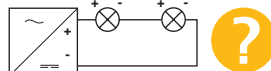
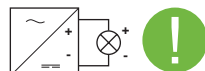

Installationshinweis für Netzgerät stromstabil [CC]: LED nicht unter Spannung anschließen!
installation instruction for power supply constant current [CC]: Don't connect LED under voltage!

POWER SUPPLIES

DC | CC

not dimmable

DEKO-LIGHT POWER SUPPLIES | DESIGN MINI

- plastic housing
- suitable for indoor and outdoor use
- short-circuit proof and overload protection



item	colour	electricity	power	voltage	max. inrush current	dimensions L x W x H	price
872026	■ black	350mA	1,10-4,00W	3-12V	10A/300µs	38 x 27 x 21 mm	13,95 €
872065	■ black	500mA	1,00-4,00W	2-8V	10A/300µs	38 x 27 x 21 mm	13,95 €
872131	■ black	700mA	1,70-4,00W	2-6V	10A/100µs	38 x 27 x 21 mm	13,95 €

NEW



DEKO-LIGHT POWER SUPPLIES | DESIGN ROUND

- plastic housing
- suitable for indoor use
- short-circuit proof and overload protection



item	colour	electricity	power	voltage	max. inrush current	dimensions L x W x H	price
862212	■ black	350mA	3,20-8,00W	9-23V	10A/300µs	53 x 22 mm	23,95 €
862128	■ black	500mA	3,00-8,00W	6-16V	8A/300µs	53 x 22 mm	23,95 €
862129	■ black	700mA	4,20-8,00W	6-12V	8A/300µs	53 x 22 mm	23,95 €



POWER SUPPLIES

DC | CC
not dimmable



design example

DEKO-LIGHT POWER SUPPLIES | DESIGN FLAT

- plastic housing
- suitable for indoor use
- flicker free
- short-circuit proof and overload protection

item	colour	electricity	power	voltage	max. inrush current	dimensions L x W x H	price
872628	■ black	350mA	0,70-6,00W	2-18V	10A/300µs	98 x 46 x 11 mm	18,95 €
862223	■ black	350mA	0,70-12,00W	2-35V	10A/100µs	128 x 50 x 13 mm	25,95 € NEW
872634	■ black	350mA	0,70-20,00W	2-57V	15A/300µs	154 x 50 x 14 mm	31,95 €
862130	■ black	500mA	1,00-6,00W	2-12V	10A/300µs	98 x 46 x 11 mm	18,95 €
862225	■ black	500mA	1,00-12,00W	2-24V	10A/100µs	128 x 50 x 13 mm	25,95 € NEW
862132	■ black	500mA	1,00-20,00W	2-40V	15A/300µs	154 x 50 x 14 mm	31,95 €
862048	■ black	700mA	1,40-6,00W	2-9V	10A/300µs	98 x 46 x 11 mm	18,95 €
862049	■ black	700mA	1,40-12,00W	2-19V	12A/300µs	128 x 50 x 14 mm	25,95 €
862050	■ black	700mA	1,40-20,00W	2-31V	15A/300µs	128 x 50 x 14 mm	31,95 €



HEP POWER SUPPLIES G5S10W

- plastic housing
- suitable for indoor use
- flicker free
- short-circuit proof and overload protection



item	colour	electricity	power	voltage	max. inrush current	dimensions L x W x H	price
862239	□ white	350mA	6,0-10,0W	17 - 29V	4,7A/30µs	58 x 39 x 20 mm	26,95 € NEW
862238	□ white	500mA	6,5-10,0W	13 - 20V	4,7A/30µs	58 x 39 x 20 mm	26,95 € NEW



POWER SUPPLIES

DC | CC

not dimmable



DEKO-LIGHT POWER SUPPLIES | DESIGN BASIC

design example

- plastic housing
- suitable for indoor use
- flicker free
- short-circuit proof and overload protection

item	colour	electricity	power	voltage	max. inrush current	dimensions L x W x H	price
180512	■ black	350mA	0,70-18,00W	2-52V	10A/300µs	115 x 45 x 21 mm	26,95 €
180513	■ black	500mA	1,00-18,00W	2-38V	10A/300µs	115 x 45 x 21 mm	26,95 €
862196	■ black	500mA	15,00-30,00W	30-60V	8A/300µs	127 x 43 x 28 mm	31,95 € NEW
862197	■ black	500mA	20,00-40,00W	40-80V	20A/300µs	127 x 43 x 28 mm	33,95 € NEW
180514	■ black	700mA	1,40-18,00W	2-26V	10A/300µs	115 x 45 x 21 mm	26,95 €
862198	■ black	700mA	9,10-30,00W	13-43V	8A/300µs	142 x 50 x 24 mm	31,95 €
862199	■ black	700mA	20,30-40,00W	29-57V	20A/300µs	127 x 43 x 28 mm	33,95 € NEW
862157	■ black	900mA	19,80-40,00 W	22-44V	20A/300µs	127 x 43 x 28 mm	33,95 €
862133	■ black	1050mA	9,50-30,00W	9-28V	5A/300µs	142 x 50 x 24 mm	31,95 €
862201	■ black	1050mA	12,60-40,00W	12-38V	20A/300µs	142 x 50 x 24 mm	33,95 €





DEKO-LIGHT POWER SUPPLIES | DESIGN MINI

- plastic housing
- suitable for indoor and outdoor use
- short-circuit proof and overload protection
- dimmable with compatible [C-capable] trailing or leading edge phase dimmers



item	colour	electricity	power	voltage	max. inrush current	dimensions L x W x H	price	
872132	■ black	350mA	2,10-4,00W	6-12V	5A/100µs	50 x 31 x 21 mm	20,95 €	NEW
872014	■ black	500mA	2,00-4,00W	4-8V	5A/300µs	50 x 27 x 21 mm	20,95 €	
872134	■ black	700mA	2,00-4,00W	2,5-6V	5A/100µs	50 x 31 x 21 mm	20,95 €	NEW



POWER SUPPLIES

DC | CC
dimnable

DEKO-LIGHT POWER SUPPLIES | DESIGN OCTO

- plastic housing
- suitable for indoor and outdoor use
- short-circuit proof and overload protection
- dimmable with compatible [C-capable] phase cut-off dimmers



item	colour	electricity	power	voltage	max. inrush current	dimensions L x W x H	price
862235	■ black	350mA	6,30-12,00W	18-37V	5A/100µs	50 x 48 x 24 mm	32,95 € NEW
862236	■ black	500mA	6,00-12,00W	12-24V	5A/100µs	50 x 48 x 24 mm	32,95 € NEW
862237	■ black	700mA	7,00-12,00W	10-17V	5A/100µs	50 x 48 x 24 mm	32,95 € NEW



DEKO-LIGHT POWER SUPPLIES | DESIGN BASIC

- plastic housing
- suitable for indoor use
- short-circuit proof and overload protection
- overheat control
- dimmable with compatible [C-capable] phase cut-off dimmers



design example

item	colour	electricity	power	voltage	max. inrush current	dimensions L x W x H	price
862202	■ black	350mA	3,90-9,00W	11- 26V	10A/300µs	115 x 39 x 22 mm	31,95 €
862203	■ black	350mA	6,30-12,00W	18-35V	10A/300µs	115 x 39 x 22 mm	39,95 €
862204	■ black	350mA	9,80-20,00W	28,57V	15A/300µs	127 x 44 x 28 mm	44,95 €
862205	■ black	500mA	10,00-20,00W	20-40V	15A/300µs	127 x 44 x 28 mm	46,95 €
862136	■ black	500mA	20,00-40,00W	40-80V	5A/300µs	166 x 52 x 24 mm	53,95 €
862207	■ black	700mA	9,80-20,00W	14-28V	15A/300µs	127 x 44 x 28 mm	46,95 €
862208	■ black	700mA	19,60-40,00W	28-56V	5A/300µs	166 x 52 x 24 mm	53,95 €
872647	■ black	1050mA	9,80-22,00W	9-20V	15A/300µs	127 x 44 x 28 mm	46,95 €
862209	■ black	1050mA	20,00-40,00W	19-38V	5A/300µs	166 x 52 x 25 mm	53,95 €
862210	■ black	1050mA	23,50-45,00W	22-43V	5A/100µs	166 x 52 x 25 mm	59,95 €
862211	■ black	1300mA	26,00-50,00W	20-39V	5A/300µs	166 x 52 x 25 mm	68,95 €
862138	■ black	1400mA	19,60-40,00W	14-28V	5A/300µs	166 x 52 x 24 mm	53,95 €



POWER SUPPLIES

DC | CC
dimmable



design example



quick installation
with through-wiring

DEKO-LIGHT POWER SUPPLIES | DESIGN QUICK

- plastic housing
- suitable for indoor use
- flicker free
- short-circuit proof and overload protection
- overheat control
- particularly easy and quick to install due to integrated 3-pole through-wiring
- no additional installation material necessary
- dimmable with compatible [C-capable] phase cut-off dimmers

item	colour	electricity	power	voltage	max. inrush current	dimensions L x W x H	price
862257	■ black	450mA	9,90-20,00W	22-44V	15A/300µs	184 x 51 x 32 mm	36,95 € NEW
862258	■ black	1050mA	23,10-45,00W	22-43V	5A/100µs	184 x 51 x 32 mm	46,95 € NEW
862259	■ black	1500mA	30,00-60,00W	20-40V	5A/100µs	184 x 51 x 32 mm	56,95 € NEW



POWER SUPPLIES

DC | CC
dimmissible



HEP POWER SUPPLY LMTc15W350LR-Z

- dimmable via leading edge or phase cut-off
- suitable for indoor use

item	colour	electricity	power	voltage	max. inrush current	dimensions L x W x H	price
862142	<input type="checkbox"/> white	350mA	8,80-14,70W	25 - 42V	15A/28µs	115 x 40,4 x 25 mm	35,95 €



DEKO-LIGHT POWER SUPPLY | BASIC MULTI-CURRENT

- plastic housing
- suitable for indoor use
- flicker free
- short-circuit proof and overload protection
- current range adjustable
- dimmable with compatible [C-capable] trailing or leading edge phase dimmers



item	colour	electricity	power	voltage	max. inrush current	dimensions L x W x H	price
862141	<input type="checkbox"/> white	350mA	3,20 - 14,00W	9-40V	15A/90µs	150 x 43 x 28 mm	46,95 €
		400mA	3,60 - 16,00W	9-40V			
		450mA	4,00 - 18,00W	9-40V			
		500mA	4,50 - 20,00W	9-40V			
		550mA	5,00 - 19,80W	9-36V			
		600mA	5,40 - 19,80W	9-33V			
		650mA	5,90 - 19,50W	9-30V			
		700mA	6,30 - 19,60W	9-28V			



POWER SUPPLIES

DC | CC
dimmable

DEKO-LIGHT MULTI-CURRENT DALI 2.0 POWER SUPPLIES DALI 2 IE-12D | IE-25D | IE-45D | IE-45HD | IE-75D

A must for every electrician: the new MULTI-CC DALI 2.0 power supplies from DEKO-LIGHT are a real all-purpose weapon for universal use.

They can be controlled via DALI1 or DALI2 [fully upward and downward compatible] or via Intelli-Push. In this case, the multi-current-power supplies do not require any additional control components and are controlled by means of cost-effective 230V standard push-buttons. With the new Intelli-Push function, they also have a pioneering synchronisation option if one of the connected power supplies no longer runs synchronously with the others.

In addition, the MULTI-power supplies can also be operated undimmed without control as a reliable and universal power supplier. With a total of five models, the new DALI series covers a CC current range from 180mA to 1600mA and power ratings from 4 to 75 watts.

- plastic housing
- compact housing design
- suitable for indoor use
- flicker free
- short-circuit proof and overload protection
- overheat control
- current range adjustable via DIP switch
- DALI 2 BUS ready according to IEC 62386
- fully downward compatible with DALI 1
- dimming range: 1-100%
- dimmable via DALI or touch dimmer function [push] new Intelli-Push function [key combination synchronises all connected power supplies]
- can also be operated without control as universal power supply unit universal power supply [no dimming function]
- 3.2-75 watts and 37 CC variants in only 3 different housing sizes



design example 114 x 52 x 24 mm



design example 139 x 75 x 30 mm



design example 159 x 79 x 30 mm

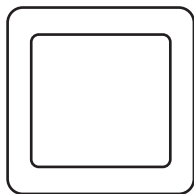

controllable with DALI2, DALI1 or by touch dim using a regular 230V push-button

TOUCH-DIM / INTELLI-PUSH VIA 230V PUSH BUTTON WITHOUT ADDITIONAL CONTROL:

press button short switch lamp on/off

press button long dim lamp bright/dark/bright

press button for 15 seconds

All connected power supplies are synchronised to the same brightness.

item	colour	electricity	power	voltage	max. inrush current	dimensions L x W x H	price
862190	■ black	180mA	3,20 - 9,80W	18 - 54V	30A/300µs	114 x 52 x 24 mm	64,95 €
		230mA	4,00 - 12,00W	18 - 52V			
		260mA	4,00 - 12,00W	15 - 46V			
		300mA	4,50 - 12,00W	15 - 42V			
		350mA	4,20 - 12,00W	15 - 34V			
		400mA	6,00 - 12,00W	15 - 30V			
		450mA	5,40 - 12,00W	15 - 27V			
		500mA	7,50 - 12,00W	15 - 24V			
862191	■ black	260mA	5,00 - 15,50W	20 - 60V	30A/300µs	114 x 52 x 24 mm	69,95 €
		350mA	7,00 - 20,00W	20 - 60V			
		400mA	8,00 - 24,00W	20 - 60V			
		450mA	9,00 - 25,00W	20 - 55V			
		500mA	10,00 - 25,00W	20 - 50V			
		550mA	11,00 - 25,00W	20 - 45V			
		600mA	12,00 - 25,00W	20 - 42V			
		700mA	14,00 - 25,00W	20 - 36V			
862192	■ black	350mA	8,75 - 24,50W	25 - 70V	55A/100µs	139 x 75 x 30 mm	74,95 €
		500mA	12,50 - 35,00W	25 - 70V			
		600mA	15,00 - 42,00W	25 - 70V			
		700mA	17,50 - 45,00W	25 - 64V			
		800mA	20,00 - 45,00W	25 - 56V			
		900mA	22,50 - 45,00W	25 - 50V			
		1050mA	25,00 - 45,00W	21 - 43V			
		862193	■ black	1050mA			
1150mA	16,10 - 45,00W			14 - 39V			
1200mA	16,80 - 45,00W			14 - 38V			
1300mA	18,20 - 45,00W			14 - 35V			
1400mA	19,60 - 45,00W			14 - 32V			
1500mA	21,00 - 45,00W			14 - 30V			
1600mA	22,40 - 45,00W			14 - 28V			
862194	■ black			1050mA	26,30 - 74,50W	25 - 71V	55A/300µs
		1150mA	28,80 - 74,80W	25 - 65V			
		1200mA	30,00 - 74,40W	25 - 62V			
		1300mA	32,50 - 75,50W	25 - 58V			
		1400mA	35,00 - 74,20W	25 - 53V			
		1500mA	37,50 - 75,00W	25 - 50V			
		1600mA	40,00 - 75,20W	25 - 47V			



POWER SUPPLIES

DC | CC
dimmable



design example

MEANWELL LCM DALI-POWER SUPPLIES 25DA2 | 40DA2 | 60DA2

- current range via DIP switch adjustable
- Dali Bus ready according to IEC 62386
- dimmable via DALI2, DALI1 or Intelli-Push [Touch-Dim via 230V push-button]
- master/slave operation of several power supplies via Sync cable [accessories]
- suitable for indoor use

item	colour	electricity	power	voltage	max. inrush current	dimensions L x W x H	price
862246	□ white	350mA	2,10 - 18,90W	6 - 54V	20A/260µs	105 x 68 x 23 mm	89,95 € NEW
		500mA	3,00 - 25,20W	6 - 50V			
		600mA	3,60 - 25,20W	6 - 42V			
		700mA	4,20 - 25,20W	6 - 36V			
		900mA	5,40 - 25,20W	6 - 28V			
		1050mA	6,30 - 25,20W	6 - 24V			
862247	□ white	350mA	0,70 - 35,00W	2 - 100V	20A/260µs	124 x 82 x 23 mm	104,95 € NEW
		500mA	1,00 - 40,00W	2 - 80V			
		600mA	1,20 - 40,00W	2 - 67V			
		700mA	1,40 - 40,00W	2 - 57V			
		900mA	1,80 - 40,50W	2 - 45V			
		1050mA	2,10 - 42,00W	2 - 40V			
862248	□ white	500mA	1,00 - 45,00W	2 - 90V	20A/260µs	124 x 82 x 23 mm	109,95 € NEW
		600mA	1,20 - 54,00W	2 - 90V			
		700mA	1,40 - 60,30W	2 - 86V			
		900mA	1,80 - 60,30W	2 - 67V			
		1050mA	2,10 - 59,90W	2 - 57V			
		1400mA	2,80 - 59,00W	2 - 42V			



Zubehör

930412 SYNC cable for synchronisation of max. 10 power supply units with push function, length 300 cm **9,95 €**

POWER SUPPLIES

DC | CC
dimmable



design example

MEANWELL LCM KNX-POWER SUPPLIES 25KN | 40KN | 60KN

- current range via DIP switch adjustable
- KNX/EIB BUS eady
- suitable for indoor use
- flicker free

item	colour	electricity	power	voltage	max. inrush current	dimensions L x W x H	price
862174	☐ white	350 mA	2,10 - 18,90W	6 - 54V	20A/260µs	105 x 68 x 23 mm	134,95 €
		500 mA	3,00 - 25,20W	6 - 50V			
		600 mA	3,60 - 25,20W	6 - 42V			
		700 mA	4,20 - 25,20W	6 - 36V			
		900 mA	5,40 - 25,20W	6 - 28V			
		1050 mA	6,30 - 25,20W	6 - 24V			
862175	☐ white	350 mA	0,70 - 35,00W	2 - 100V	20A/260µs	124 x 82 x 23 mm	144,95 €
		500 mA	1,00 - 40,00W	2 - 80V			
		600 mA	1,20 - 40,00W	2 - 67V			
		700 mA	1,40 - 40,00W	2 - 57V			
		900 mA	1,80 - 40,50W	2 - 45V			
		1050 mA	2,10 - 42,00W	2 - 40V			
862176	☐ white	500 mA	1,00 - 45,00W	2 - 90V	20A/260µs	124 x 82 x 23 mm	154,95 €
		600 mA	1,20 - 54,00W	2 - 90V			
		700 mA	1,40 - 60,30W	2 - 86V			
		900 mA	1,80 - 60,30W	2 - 67V			
		1050 mA	2,10 - 59,90W	2 - 57V			
		1400 mA	2,80 - 59,00W	2 - 42V			



POWER SUPPLIES

DC | CC
dimnable



design example

MEANWELL LCM CASAMBI POWER SUPPLIES 25BLE | 40BLE | 60BLE

- suitable for indoor use
- current range via DIP switch adjustable
- dimmable via CASAMBI app or touch dim via 230V push-button
- flicker free

item	colour	electricity	power	voltage	max. inrush current	dimensions L x W x H	price	
862243	<input type="checkbox"/> white	350mA	2,10 - 18,90W	6 - 54V	20A/260µs	105 x 68 x 23 mm	239,95 €	NEW
		500mA	3,00 - 25,20W	6 - 50V				
		600mA	3,60 - 25,20W	6 - 42V				
		700mA	4,20 - 25,20W	6 - 36V				
		900mA	5,40 - 25,20W	6 - 28V				
		1050mA	6,30 - 25,20W	6 - 24V				
862244	<input type="checkbox"/> white	350mA	0,70 - 35,00W	2 - 100V	20A/260µs	124 x 82 x 23 mm	249,95 €	NEW
		500mA	1,00 - 40,00W	2 - 80V				
		600mA	1,20 - 40,00W	2 - 67V				
		700mA	1,40 - 40,00W	2 - 57V				
		900mA	1,80 - 40,50W	2 - 45V				
		1050mA	2,10 - 42,00W	2 - 40V				
862245	<input type="checkbox"/> white	500mA	1,00 - 45,00W	2 - 90V	20A/260µs	124 x 82 x 23 mm	259,95 €	NEW
		600mA	1,20 - 54,00W	2 - 90V				
		700mA	1,40 - 60,30W	2 - 86V				
		900mA	1,80 - 60,30W	2 - 67V				
		1050mA	2,10 - 59,90W	2 - 57V				
		1400mA	2,80 - 59,00W	2 - 42V				



POWER SUPPLIES

DC | CC
dimnable



TCI POWER SUPPLY JOLLY MD PUSH

- suitable for indoor use
- constant current [CC] or constant voltage [CV] adjustable via DIP switch
- dimmable via leading edge or push [Touch dim via 230V push button]
- master/slave operation of several power supplies via sync cable [accessories]

item	colour	operating mode	electricity	power	voltage	dimensions L x W x H	price
561201	<input type="checkbox"/> white	stromkonstant	350mA	0,70 - 16,50W	2 - 47V	165 x 48 x 35 mm	96,95 €
			500mA	1,00 - 23,50W	2 - 47V		
			550mA	1,10 - 25,90W	2 - 47V		
			700mA	1,40 - 32,00W	2 - 46V		
			750mA	1,50 - 32,00W	2 - 43V		
		spannungskonstant	12V	10W			
			24V	20W			
			28V	22W			



Zubehör

561202	SYNC cable for synchronisation of max. 10 power supply units with push function, length 150 cm	10,95 €
---------------	--	----------------

electr. data		dimmable via				usage / design			electrical limit values		power supply	
current strength	power	electronic power supply	conventional transformer	leading edge	leading edge / cut-off	indoor	outdoor	design	capacitive load	max. quantity per automatic circuit breaker	item number	page
		electronic transformers:										
12V	0,0-70,0 W	x			x	x		basic	97.79nF	B10A=8, B16A=14, C10A=18, C16A=29	180515	725
12V	20,0-70,0 W	x			x	x		basic		B10A=8, B16A=14, C10A=8, C16A=14	862187	725
12V	0,0-105,0 W	x			x	x		basic	139.58nF	B10A=5, B16A=9, C10A=12, C16A=19	180529	725
12V	34,0-105,0 W	x			x	x		basic		B10A=8, B16A=14, C10A=8, C16A=14	862188	725
12V	50,0-150,0 W	x			x	x		basic		B10A=8, B16A=14, C10A=8, C16A=14	862189	725
wound transformers:												
12V	11,5-20,0 W		x	x		x		*			000097	726
12V	34,5-60,0 W		x	x		x		*			000099	726
12V	43,5-75,0 W		x	x		x	x	*			000140	726
12V	60,5-105,0 W		x	x		x		*			000107	726
12V	86,5-150,0 W		x	x		x		*			000103	726
12V	86,5-150,0 W		x	x		x	x	*			000141	726
12V	115,0-200,0 W		x	x		x		*			000104	726
12V	172,5-300,0 W		x	x		x		*			000106	726
12V	172,5-300,0 W		x	x		x	x	*			000142	726
12V	287,5-500,0 W		x	x		x		*			000109	726

power supplies design



mini



round / octo



flat



basic



long-flat



IP

* special design

POWER SUPPLIES

AC | CV
dimmissible

DEKO-LIGHT TRANSFORMATOR ULTRA HALOGEN 12 VOLT / AC

- electronic transformer [12V]
- lamp protection voltage
- plastic housing
- suitable for indoor use
- flicker free
- short-circuit proof and overload protection
- dimmable with compatible [C-capable] trailing or leading edge phase dimmers
- **180515**: 0-70W halogen bulbs or 0-50W / max. 6 LED illuminants
- **180529**: 0-105W halogen bulbs or 0-50W / max. 6 LED illuminants



design example

item	colour	voltage	power	electricity	max. inrush current	dimensions L x W x H	price
180515	■ black	12V	0 - 70W	0-5830 mA	20A/300µs	115 x 45 x 28 mm	19,95 €
180529	■ black	12V	0 - 105W	0-8750mA	30A/300µs	115 x 45 x 28 mm	24,95 €



OSRAM HALOTRONIC MOUSE TRANSFORMATOR 12 VOLT / AC

The Osram Halotronic Mouse Transformer is ideal for confined spaces. The Halotronic Mouse series is dimmable via leading or trailing edge dimmers. With the 150VA version, you have the option of primarily looping on using two pairs of terminals.

- electronic transformer [12V]
- lamp protection voltage
- plastic housing
- suitable for indoor use
- short-circuit proof and overload protection
- dimmable with compatible [C-capable] trailing or leading edge phase dimmers



item	colour	voltage	power	electricity	max. inrush current	dimensions L x W x H	price
862187	□ white	12V	20 - 70W	1785-6250 mA	5A/300µs	108 x 52 x 33 mm	36,95 €
862188	□ white	12V	34 - 105W	3100-9300 mA	7,5A/300µs	108 x 52 x 33 mm	39,95 €
862189	□ white	12V	50 - 150W	4390-13160 mA	11A/300µs	153 x 54 x 36 mm	60,95 €



POWER SUPPLIES

AC | CV
dimnable

ABN TRANSFORMATOREN 12 VOLT / AC

- conventional transformer
- lamp protection voltage
- dimmable via leading edge
- suitable for indoor use



design example

item	colour	voltage	power	dimensions L x W x H	price
000097	<input type="checkbox"/> white	20VA	11,50 - 20,00 W	82 x 56 x 50 mm	36,95 €
000099	<input type="checkbox"/> white	60VA	34,50 - 60,00 W	100 x 70 x 61 mm	54,95 €
000107	<input type="checkbox"/> white	105VA	60,50 - 105,00 W	107 x 78 x 66 mm	74,95 €
000103	<input type="checkbox"/> white	150VA	86,50 - 150,00 W	130 x 88 x 78 mm	84,95 €
000104	<input type="checkbox"/> white	200VA	115,00 - 200,00 W	130 x 88 x 88 mm	94,95 €
000106	<input type="checkbox"/> white	300VA	172,50 - 300,00 W	130 x 88 x 103 mm	124,95 €
000109	<input type="checkbox"/> white	500VA	287,50 - 500,00 W	177 x 107 x 130 mm	224,95 €



optional accessories transformer housing Pyra

000110	for 105 W	19,95 €
000111	for 150-300 W	19,95 €

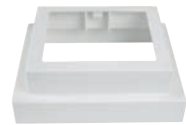

ABN TRANSFORMERS 12 VOLT / AC

- conventional transformer
- lamp protection voltage
- 1,9 m connection cable [primary]
- 0,5 m connection cable [secondary]
- dimmable via leading edge
- suitable for indoor and outdoor use



design example

item	colour	voltage	power	dimensions L x W x H	price
000140	<input checked="" type="checkbox"/> black	75VA	43,50 - 75,00 W	108 x 81 x 66 mm	89,95 €
000141	<input checked="" type="checkbox"/> black	150VA	86,50 - 150,00 W	130 x 93 x 78 mm	109,95 €
000142	<input checked="" type="checkbox"/> black	300VA	172,50 - 300,00 W	130 x 93 x 102 mm	149,95 €



ELECTRONICAL BALLAST

other
not dimmable

OSRAM HQI ELECTRONICAL BALLAST PT170

- for 70W metal vapour lamps
- dimensions L x W x H: 171 x 83 x 32 mm
- automatic safety shutdown in case of lamp damage
- incl. pull relief
- suitable for indoor use



item	colour	price
150921	<input type="checkbox"/> white	84,95 €



HEP HQI ELECTRONICAL BALLAST SH70GB

- für 70W metal vapour lamps
- dimensions L x W x H: 110 x 75 x 32 mm
- suitable for indoor use



item	colour	price
800030	<input checked="" type="checkbox"/> black	84,95 €



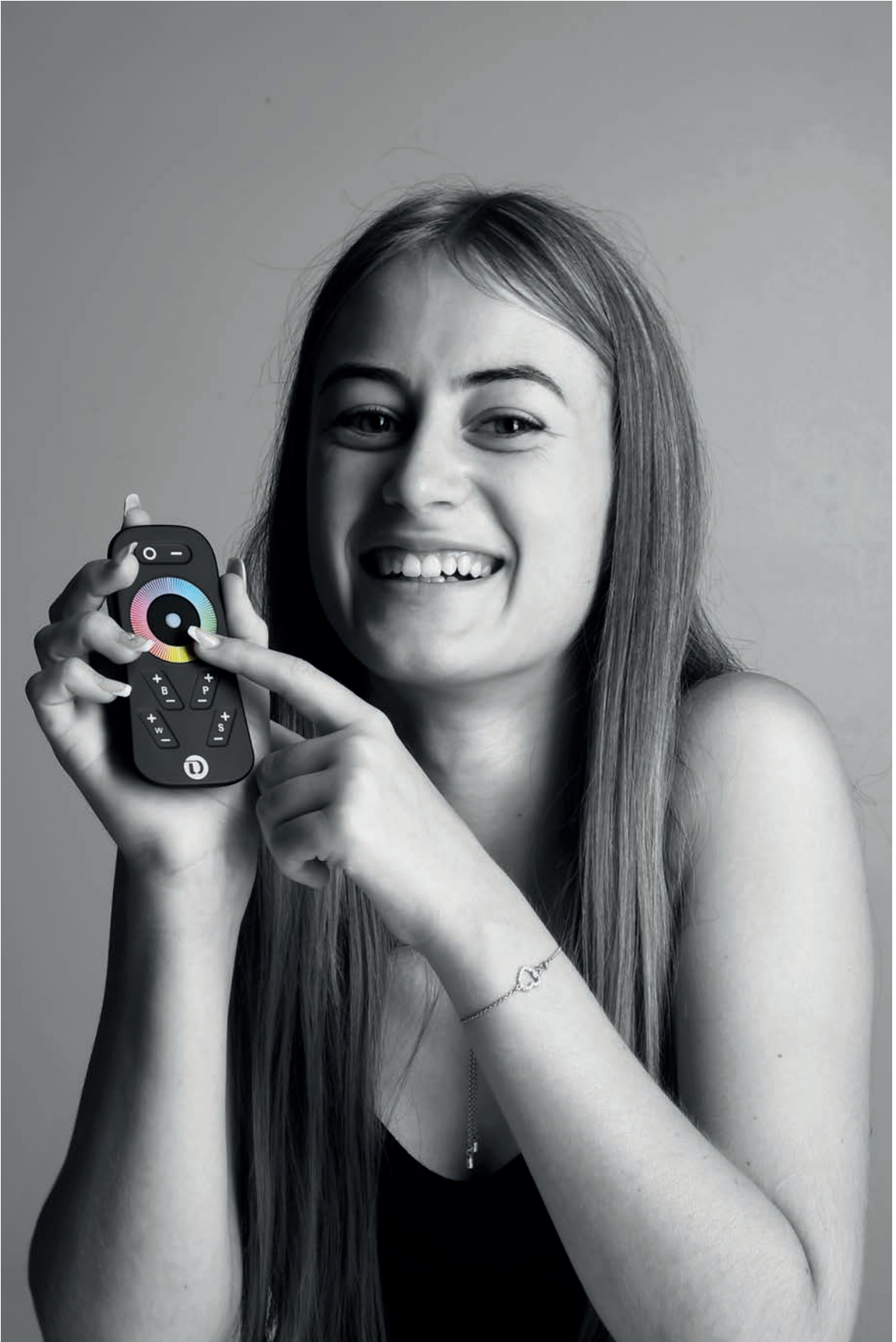

CONTROLLER

- 732 Quasar
- 740 Casambi Bluetooth
- 742 RF controller | 1 - 4 channel
- 744 RF touchpanel | 1 - 4 channel
- 746 quick finder | DMX controller
- 747 quick finder | DMX dimmer
- 748 DMX wall controller
- 752 DMX controller
- 754 DMX dimmer
- 758 DALI PWM dimmer



■ Quasar
page 734

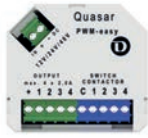

□ Quasar
page 735



■ Quasar
page 737



□ Quasar
page 738



□ Casambi Bluetooth
page 740



□ Casambi Bluetooth
page 740



□ Casambi Bluetooth
page 741



□ ■ Casambi Bluetooth
page 741



■ □ RF controller | 1 - 4 channel
from page 742



□ □ RF touchpanel | 1 - 4 channel
from page 744



■ DMX wall controller
page 748



■ DMX wall controller
page 748



■ DMX wall controller
page 749



■ DMX wall controller
page 750



■ DMX wall controller
page 750



■ DMX wall controller
page 751



■ DMX controller
page 752



■ DMX controller
page 753



■ DMX dimmer
page 754



■ DMX dimmer
page 754



■ DMX dimmer
page 755



■ DMX dimmer
page 755



DMX dimmer
page 755



DMX dimmer
page 756



DMX dimmer
page 756



DMX dimmer
page 757



DMX dimmer
page 757



DALI PWM dimmer
page 758



DALI PWM dimmer
page 758



DALI PWM dimmer
page 759

controller

DEKO-LIGHT QUASAR – THE SMART UNIVERSAL CONTROL FOR LIGHT & CO.

Our new and universal Bluetooth control »Quasar« enables you to use and control all common lighting components such as lights, lamps, LED strips etc. as well as electrical devices with 230V mains voltage.

You decide whether you want to do this conveniently via smartphone, tablet and / or light switches. Through the integrated inputs for conventional light switches, »Quasar« can be perfectly integrated into an existing electrical installation and thus also into the existing switch range. It does not matter whether you want to plan, modernize or expand a new building.

Thanks to the pre-configured Quasar modules [see Fig.] installation and commissioning are child's play. Immediately after connection, all necessary function tests of the connected components can be carried out. This reduces installation costs and increases efficiency.

With the app, we also made sure to create a user-friendly and intuitive user interface. It controls both all standard functions that are also available when operated with switches, as well as the many additional and automatic functions that make your lighting control system »smart« and comfortable. So there are almost no limits to your imagination.

Speaking of limits – thanks to the latest Multi-Protocol-Mesh-Technology and the interaction of the individual modules, these automatically connect to form a network with which even complex lighting control networks with extensive requirement profiles can be set up. Every module is part of the network and thus also extends the range of the radio network, but can also be completely independent.

Quasar is simple, flexible, comfortable, safe and incredibly smart.

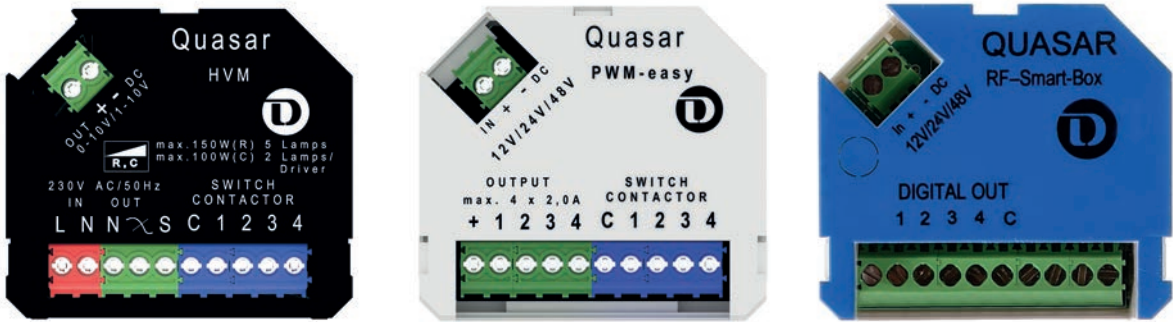

original size

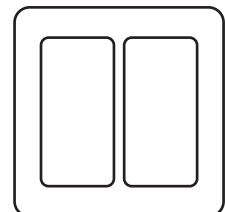

WHAT CAN QUASAR CONTROL?

By using the two modules [see pages 802-805] there are countless connection options for almost all types of common lights, illuminants and components. From conventional light bulbs, LED / retro-Fit lamps, LED lights with permanently installed electronic ballasts, power supplies with 0-10V / 1-10V control input, 1-4 channel LED strips and all compatible devices and consumers that can be switched or dimmed using 230V mains voltage.

OPTIONAL OPERATING MODES

Depending on the Quasar module used and the connected one consumers can select the required operating mode quickly and easily. Switching, dimming, different modes for 1-4 channel LED strips and a special sensor mode enable previously unimagined control options and functions.

RANGE AND SECURITY

By using the latest microprocessors and encrypted Multi-Protocol-Mesh-Technology, the Quasar modules offer maximum security and maximum range. Each module also serves as a repeater within the network and increases the range accordingly. Any Quasar module can be used as a repeater to connect controllers that are too far away. Both the Quasar control modules and the Quasar app can be kept up to date by software updates if required. So you always enjoy the full and updated range of functions.

EASY AND QUICK INSTALLATION

Due to the compact design and depending on the application, the modules can often be installed almost »invisibly« directly in the junction box, in the lamp canopy or with the power supply. The modules are already pre-configured for the most common applications, which means that the most important functions can be operated and tested using the switch inputs after installation, even without using the Quasar app. A multi-coloured signal LED inside the module provides information about the operating status and any faults at any time.

CUSTOMIZE SWITCHING SIGNALS

Many switching parameters such as the duty cycle, dimming behaviour, soft start, switch-on and switch-off delays as well as the minimum and maximum brightness can be adapted to the respectively connected lights or consumers.

FLEXIBLE USE AND OPERATION

The modules can be used as individual, autonomously operating controllers or in combination with many others controllers they work in networked operation. No central control unit is required. Every controller can be operated by up to 4 buttons, by app for smartphone / tablet or in combination with app and button respectively. This ensures that you can switch the lighting quickly and easily always on entering or leaving a room.

EASY APP START-UP AND CONTROL

If you want to operate the Quasar modules with a smartphone or tablet [Android / iOS, compatible from BT4.2], download the Quasar app - available free of charge in the App / Play-Store and install the app. Then everything is lightning fast: create a free user account via the intuitive menu, log in, set up the rooms in which Quasar modules are installed, scan the assembled and operational controllers and configure them according to your wishes. Your smart Quasar network is ready.



product video

control output
for 0-10V / 1-10V power supplies

original size

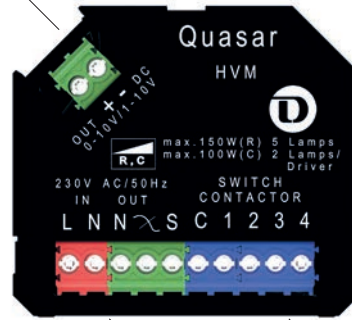

power input and output 230V

analog switches 1 - 4

DEKO-LIGHT QUASAR HVM

- plastic housing
- dimensions L x W x H: 46 x 41 x 24 mm
- stand-alone or networked operation
- quick installation through pre-installed programs and dimming functions
- controllable via up to 4 potential-free buttons and / or smartphone app
- adjustable and freely configurable: dimming level, minimum and maximum brightness, programs, speed, time- / day-dependent switching cycles
- data transmission using the latest BT-Mesh technology
- power for suitable R loads [incandescent lamp, high-voltage halogen] 1 - 150W / max. 5 components
- power for suitable C loads [high-voltage LED, electrical power supplies] 1 - 100W / max. 2 components
- control output 0-10V / 1-10V for up to 5 power supplies [switching capacity max. 100W, higher capacity by means of additional relay [not included]]
- overload, overheating, network, operation display
- connection via screw terminals

item	colour	price
843007	■ black	139,95 €



DEKO-LIGHT QUASAR HVM 230V DIMMING AND SWITCHING WITH A SMARTPHONE AND / OR BUTTON

With this small module, which is directly in a junction box or can be installed in a lamp canopy suitable lights, power supplies or other compatible 230V components can be dimmed or switched directly. Via the 0-10V / 1-10V control output, power supply units with the corresponding control input can still be dimmed and switched.

With the additional sensor function of the module, all commercially available motion detectors, twilight switches etc. that are equipped with a 230V switching output can become a radio actuator. The problem solver wherever there are no corresponding cables.

Commissioning is child's play thanks to many preconfigured scenes. To be able to use them, you only need to connect potential-free buttons [1-4 depending on the function]. Since standard push buttons are used, you can integrate Quasar into any existing electrical installation and thus into the switch ranges of all manufacturers.

DC power supply
12/24/48 volts

original size

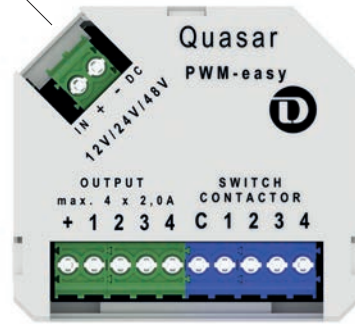

analog switches 1 - 4

switches up to 4 LED sources
with up to max. 2 A / channel
or 8 A when bridged

DEKO-LIGHT QUASAR PWM-EASY

- plastic housing
- dimensions L x W x H: 46 x 41 x 24 mm
- stand-alone or networked operation
- quick installation through pre-installed programs and dimming functions
- for the control of 1-4 channel LED stripes / lights [single, WW/CW, RGB, RGBW]
- controllable via up to 4 potential-free buttons and / or smartphone app
- adjustable and freely configurable: colours, brightness, programs, speed
- data transmission using the latest BT-Mesh technology
- max. power je Modul:
 - 12V DC = 4x 24W [each channel]
or 1x 90W [bridged mode]
 - 24V DC = 4x 48W [each channel]
or 1x 190W [bridged mode]
 - 48V DC = 4x 96W [each channel]
or 1x 380W [bridged mode]
- load quantity per module: max. 5 components of the same type
- overload, overheating, network, operation display
- connection via screw terminals [4x V-, V+]

item	colour	price
843053	<input type="checkbox"/> white	149,95 €



DEKO-LIGHT QUASAR PWM-EASY 1-4 CHANNEL STRIPES AND LED CONTROLS WITH SMARTPHONE AND / OR BUTTON

This small module can be installed directly on the corresponding power supply or in a nearby junction box and controls all common 1-4 channel LED stripes and lights [single, WW / CW, RGB, RGBW] which are operated with a voltage of 12V, 24V or 48V DC and controlled by PWM control.

As with the HVM module, commissioning is child's play thanks to the many pre-configured scenes. To be able to use them, you only need to connect potential-free buttons 1-4 depending on the function]. Since standard push buttons are used, you can integrate Quasar into any existing electrical installation and thus into the switch ranges of all manufacturers.

With this module, too, you have the option to control all basic functions as well as countless additional functions with the Quasar app for compatible Android and Apple smartphones [BT from 4.2]. The configuration and operation is simple and intuitive.

DEKO-LIGHT QUASAR RF-SMART-BOX NOT ONLY TAKES EXISTING INSTALLATIONS TO THE NEXT LEVEL

The small blue RF Smart Box is a real all-rounder, because on the one hand it makes it possible to operate an existing LED stripe installation, which was previously controlled with the popular DEKO-LIGHT RF system via remote control, can now be operated with a smartphone and thus benefit from the possibilities and advantages of a modern control system.

The conversion is very simple: connect the RF Smart Box to the existing LV power supply, plug in the RF controller and you're done! Afterwards, the app, which is available free of charge, can be put into operation and adapted accordingly.

Furthermore, there are no more performance limits to your planning with Quasar. Using the RF-Link control signal, you can control one or more RF controllers connected via RJ45 cable simultaneously. In this way, you can also realise high performance requirements of more complex or extensive installations.

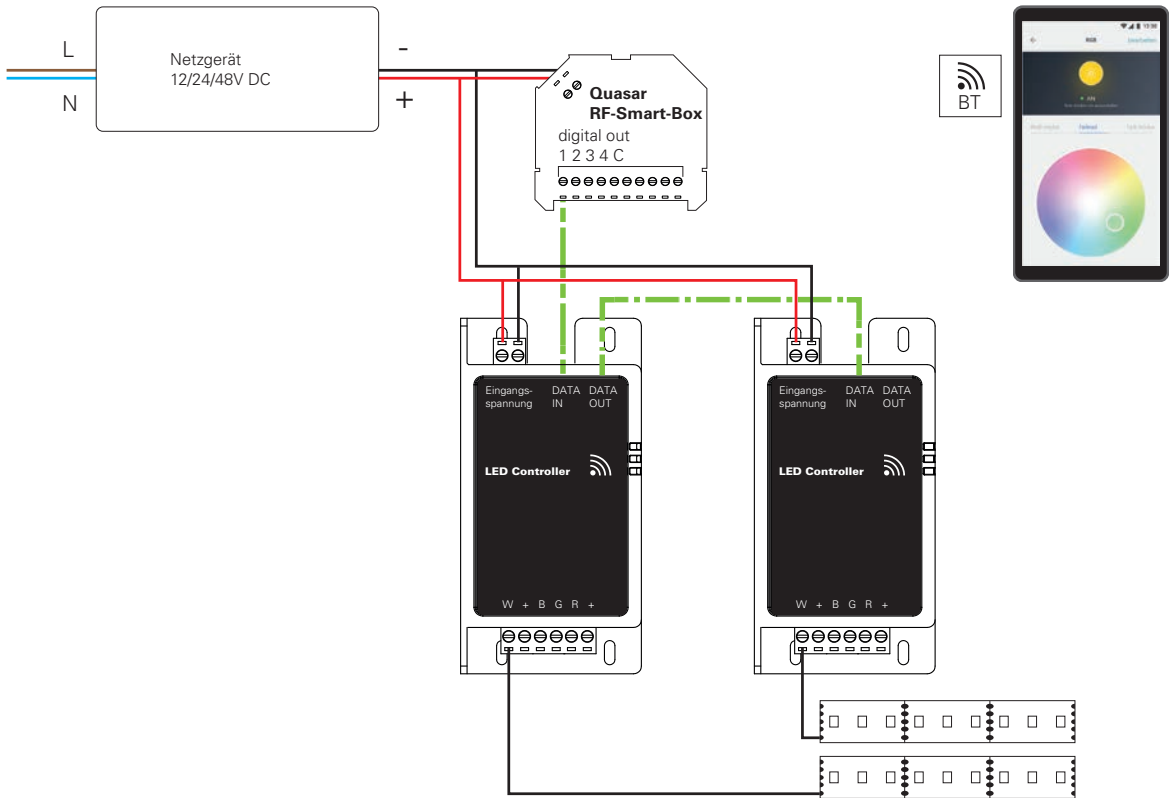

DC power supply
12 / 24 / 48 Volt

original size



RF link (digital output signal)
for control of 1-4 channel
RF controllers

DEKO-LIGHT QUASAR RF-SMART-BOX

- plastic housing
- dimensions L x W x H: 46 x 41 x 24 mm
- stand-alone or networked operation
- quick installation through pre-installed programs and dimming functions
- digital output signal [RF-Link] for controlling DEKO-LIGHT RF controllers [single, WW/CW, RGB, RGBW]
- adjustable and freely configurable: colours, brightness, programs, speed
- data transmission using the latest BT-Mesh technology
- connection via screw terminals
- CAT5 adapter incl. cable for connection to RF controller included in delivery

module incl. adapter and CAT5 cable
for connection to RF controller

item	colour	price
843061	 blue	169,95 €

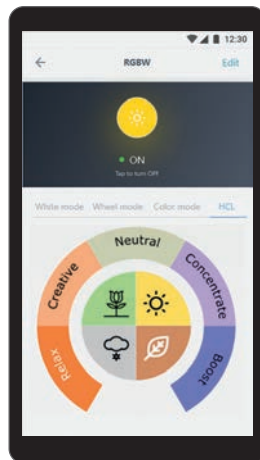
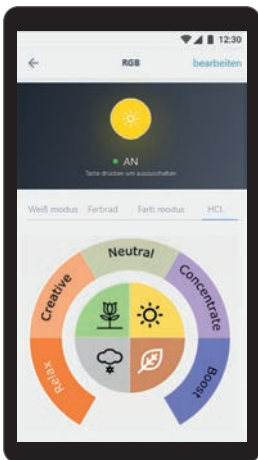
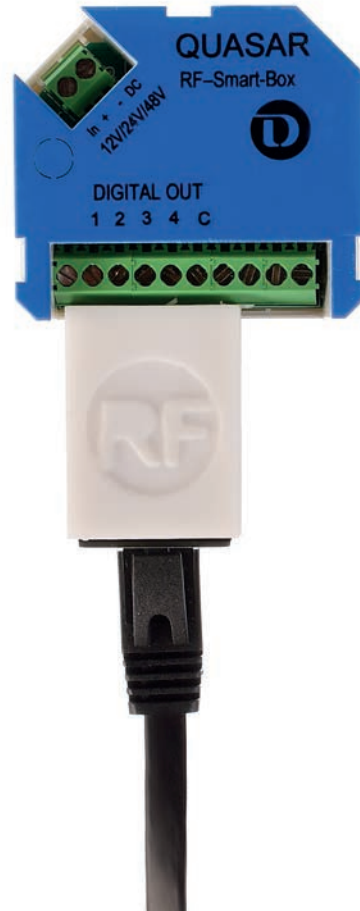

DEKO-LIGHT QUASAR GATEWAY THE WORLDWIDE CONTROL CENTRE FOR YOUR LIGHTING CONTROL SYSTEM

The completely new Quasar Gateway is a real jack-of-all-trades. By using the gateway, it takes over the control of your existing Quasar modules and additionally connects them to the internet and mobile network. This opens up completely new possibilities for use and application for your intelligent Quasar lighting control system.

Installation and commissioning is extremely simple and in a very short time: plug in, log on, enter the WLAN password and you're done!

Take advantage of the diverse and convenient possibilities of the networked Quasar light control and make your life smarter!

Features of the gateway:

- worldwide access via smartphone app to all control functions of your Quasar network
- repeater feature also within the home network
- calendar functions
- time-dependent lighting control [e.g. for HCL]
- use of Quasar modules as transmitters e.g. for sensors [motion detectors, magnetic contacts, water level sensors, temperature sensors...]
- lighting control of controllers from other suppliers [e.g. ZigBee]
- voice control [dim, colours, etc.] by standard available voice assistants
- automatic updating of all Quasar components
- central control unit of the Quasar network



DEKO-LIGHT QUASAR GATEWAY

- plastic housing
- dimensions L x W x H: 115 x 125 x 24 mm
- wall mounting possible
- radio frequency: 2,5 GHz
- data transmission through the latest BT mesh technology
- power consumption max. 20 mA
- power supply via micro USB connection cable [not included in the scope of delivery]
- umlaufende LED, die den Betriebszustand signalisiert
- simplest commissioning
- no additional monthly costs

item	colour	price
843069	<input type="checkbox"/> white	189,95 €

accessories

930460	230V USB plug-in power supply incl. micro-USB connection cable	19,95 €
--------	--	---------

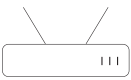
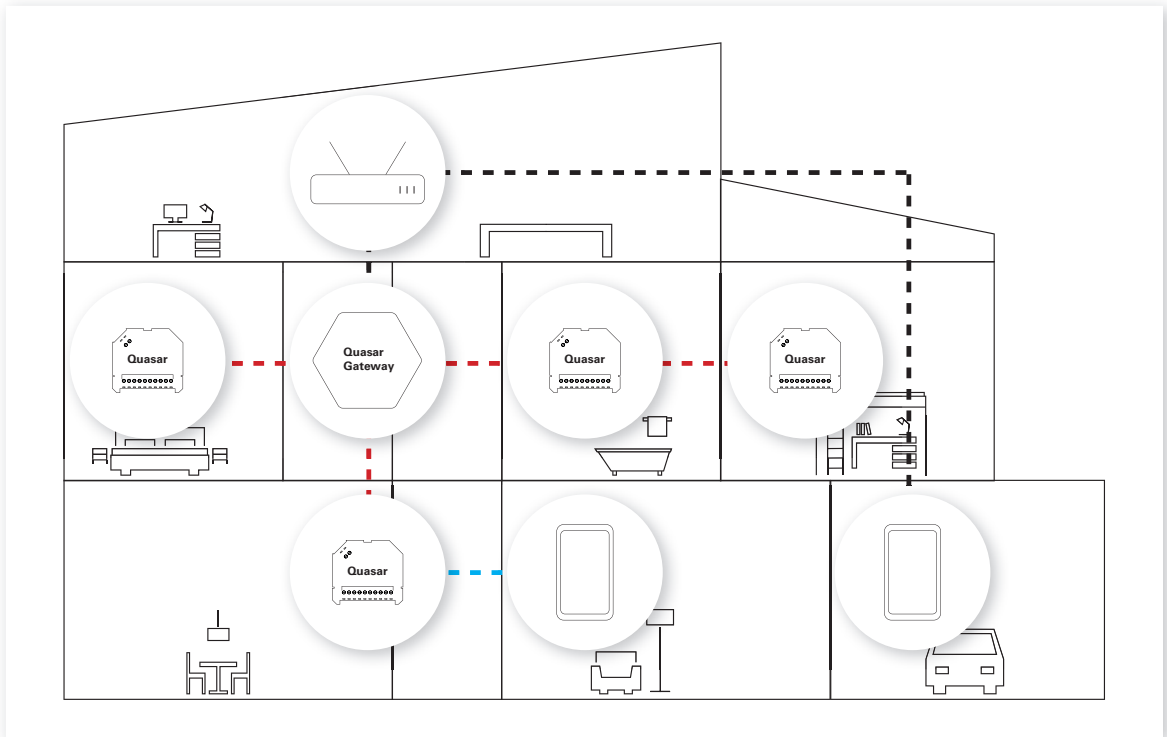

The router establishes the connection between the Internet and the home network / WLAN.



The smartphone can establish a direct connection if it is within range of a Quasar module. With the help of the gateway and a WLAN connection, modules that are out of range [e.g. in other floors or basements] can also be controlled. Quasar modules can thus be controlled worldwide via the smartphone's internet connection.



Quasar Gateway, the control centre



Quasar control module, e.g. HVM, WM-easy or RF-smart-Box



connection between smartphone and router



connection between smartphone and Quasar network



connection within the Quasar network

SMART HOME CAN BE SO SIMPLE

Install the Casambi module in the distribution box, suspended ceiling or similar – install the app from the Playstore/iTunes, connect the module to your mobile phone and the app, set it up and off you go!

CASAMBI BLUETOOTH CBU-TED | 230V SWITCHING/DIMMING

With this module 230V components can be directly dimmed or switched [configuration via mobile app].

- suitable for R-loads [light bulb, high-voltage halogen]
- suitable for C-loads [dimmable high-voltage LED, electrical power supplies]
- power in switching operation: light bulb, high-voltage halogen, high-voltage LED, electrical ballasts: max. 150W
- power in dimming mode: dimmable high-voltage LED, electrical ballasts: max. 50W / max. 2 components
- dimensions L x W x H: 40,4 x 36,3 x 14 mm



item	colour	price
843008	<input type="checkbox"/> white	144,95 €



CASAMBI BLUETOOTH CBU-ASD | DALI/0-10V | 1-10V

The module generates either a DALI, 0-10V or 1-10V control signal with which 1 ballast/power supply or similar can be operated [configuration via mobile app].

- dimensions L x W x H: 56,5 x 35,8 x 22,3 mm

item	colour	price
843011	<input type="checkbox"/> white	149,95 €



CASAMBI BLUETOOTH CBU-PWM4 | LED 1-4 CHANNEL DIMMER

With this module you can control 12V/24V LED stripes, lamps etc. with 1-4 channels [WW, CW, WW-CW, RGB, RGBW], which can be controlled by PWM [configuration via mobile app].

- dimensions L x W x H: 72,6 x 30 x 18 mm
- power 144W at 24V, 72W at 12V

item	colour	price
843037	<input type="checkbox"/> white	179,95 €



CASAMBI BLUETOOTH WAND-CONTROLLER XPRESS

- Bluetooth-wall controller compatible with Casambi-System
- mounting with screws or adhesive pad
- independent mounting, as battery operated [3V button cell] and no cabling necessary
- setup and programming via Casambi-App
- plastic
- L x W x H: 90 x 90 x 12 mm

item	colour	price
843050	<input type="checkbox"/> white	399,95 €
843049	<input checked="" type="checkbox"/> black	399,95 €



RF CONTROLLER

The respective receiving systems are controlled within a range of 20 m through remote control. The system can be expanded in a simple manner by connecting one single remote control to several controller boxes. Note: A 100% synchronous controlling [program sequence, colour change]

of several control boxes with one single remote control can be implemented only with an available network cable connection [Master-Slave function]. The memory effect saves the most recent setting after a power failure.



DEKO-LIGHT CONTROLLER SET RF SINGLE

- for controlling 1-channel LED stripes
- set consists of: controller, remote control and wall bracket
- dimmable
- 4 effect programs
- adjustable programme speed
- max. 8 remote controls / 2 touch panels per system range
- memory function
- master/slave function
- dimensions controller L x W x H: 115 x 57 x 25 mm
- max. 7,5A each channel
- power: 2x 90W [180W] at 12V DC,
2x 180W [360W] at 24V DC,
2x 360W [720W] at 48V DC

item	colour	price
843056	■ black	104,95 €

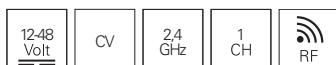

accessories for 843056

843064	controller	89,95 €
843014	remote control	32,95 €
843013	wall bracket	10,95 €
843018	touch panel	96,95 €



DEKO-LIGHT CONTROLLER SET RF WHITE

- for controlling WW/CW LED stripes
- set consists of: controller, remote control and wall bracket
- WW oder CW dimmable as single colour
- 9 effect programs
- adjustable programme speed
- max. 8 remote controls / 2 touch panels per system range
- memory function
- master/slave function
- dimensions controller L x W x H: 115 x 57 x 25 mm
- max. 7,5A each channel
- power: 2x 90W [180W] at 12V DC,
2x 180W [360W] at 24V DC,
2x 360W [720W] at 48V DC

item	colour	price
843057	■ black	109,95 €



accessories for 843057

843065	controller	89,95 €
843015	remote control	32,95 €
843013	wall bracket	10,95 €
843019	touch panel	96,95 €

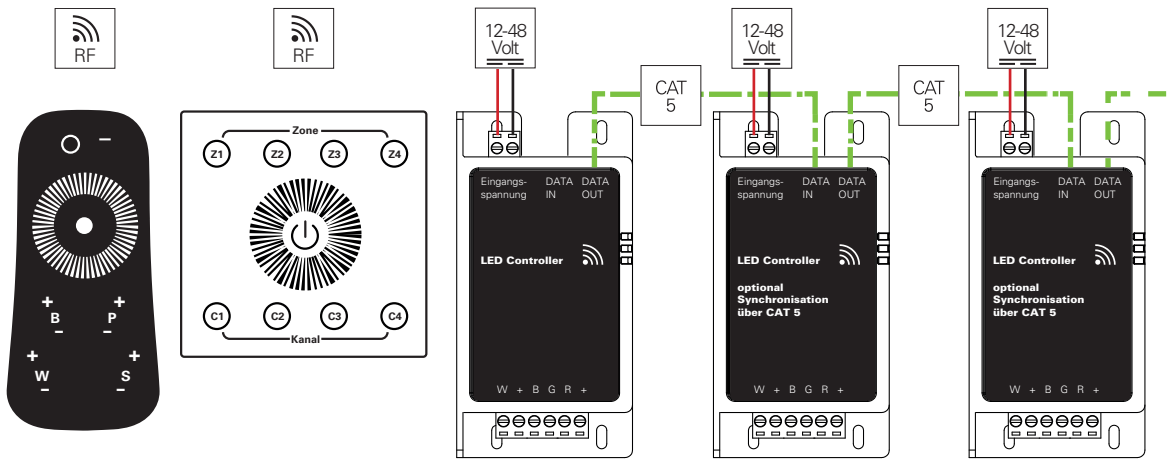

outputs for LED stripes/luminaires



DEKO-LIGHT CONTROLLER SET RF COLOR

- for controlling RGB LED stripes
- set consists of:
controller, remote control and wall bracket
- R/G/B dimmable as single colour
- 13 effect programs
- adjustable programme speed
- max. 8 remote controls / 2 touch panels
per system range
- memory function
- master/slave function
- dimensions controller L x W x H: 115 x 57 x 25 mm
- max. 5,0A each channel
- power: 3x 60W [180W] at 12V DC,
3x 120W [360W] at 24V DC,
3x 240W [720W] at 48V DC

item	colour	price
843058	■ black	114,95 €

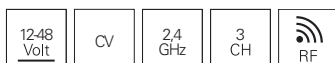

accessories for 843058

843066	controller	96,95 €
843016	remote control	32,95 €
843013	wall bracket	10,95 €
843020	touch panel	96,95 €



DEKO-LIGHT CONTROLLER SET RF COLOR & WHITE

- for controlling RGB + white LED stripes
- set consists of:
controller, remote control and wall bracket
- R/G/B + white dimmable as single colour
- 12 effect programs
- adjustable programme speed
- max. 8 remote controls / 2 touch panels
per system range
- memory function
- master/slave function
- dimensions controller L x W x H: 115 x 57 x 25 mm
- max. 5,0A each channel
- power: 4x 45W [180W] at 12V DC,
4x 90W [360W] at 24V DC,
4x 180W [720W] at 48V DC

item	colour	price
843059	■ black	119,95 €

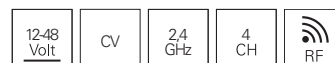

accessories for 843059

843067	controller	96,95 €
843017	remote control	32,95 €
843013	wall bracket	10,95 €
843021	touch panel	96,95 €

DEKO-LIGHT TOUCH PANEL RF WITH 4-ZONE-FUNCTION | 4 AREAS SEPARATELY CONTROLLED

The respective receiving systems are controlled within a range of 20 m through the touch panel. The system can be expanded in a simple manner by connecting one single touch panel to several controller boxes. Note: A 100% synchronous controlling [program sequence, colour change] of several control boxes with one single remote control per

zone can be implemented only with an available network cable connection [Master-Slave function]. The memory effect saves the most recent setting after a power failure. The unit is mounted in a 68mm single device box.



DEKO-LIGHT WALL TOUCH PANEL RF SINGLE

- control of the controller via radio, no additional control lines necessary
- for controlling 1-channel LED stripes / luminaires
- 4 zones
- independent dimming of individual zones
- all zones can be switched on/off together
- 4 effect programs
- adjustable programme speed
- memory function
- dimensions L x W x H: 86,5 x 86,5 x 31,1 mm

item	colour	price
843018	<input type="checkbox"/> white	96,95 €

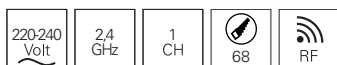

DEKO-LIGHT WALL TOUCH PANEL RF WHITE

- control of the controller via radio, no additional control lines necessary
- for controlling WW/CW LED stripes / luminaires
- 4 zones
- independent dimming of individual zones
- all zones can be switched on/off together
- 9 effect programs
- adjustable programme speed
- memory function
- dimensions L x W x H: 86,5 x 86,5 x 31,1 mm

item	colour	price
843019	<input type="checkbox"/> white	96,95 €

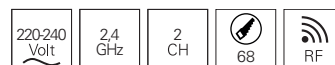

accessories for 843018

843064 controller **89,95 €**

accessories for 843019

843065 controller **89,95 €**

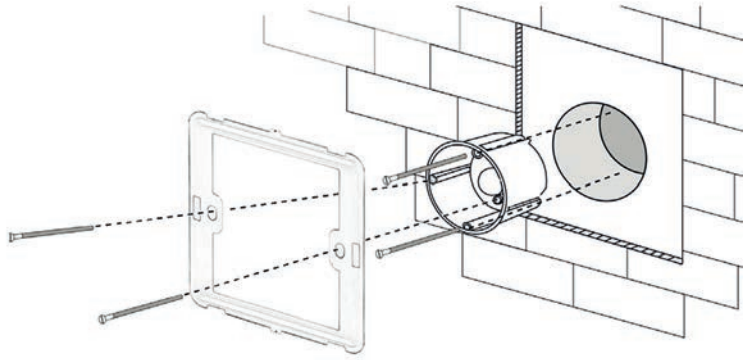

DEKO-LIGHT WALL TOUCH PANEL RF COLOR

- control of the controller via radio, no additional control lines necessary
- for controlling RGB LED stripes / luminaires
- 4 zones
- independent dimming of individual zones
- all zones can be switched on/off together
- 13 effect programs
- adjustable programme speed
- memory function
- dimensions L x W x H: 86,5 x 86,5 x 31,1 mm

item	colour	price
843020	<input type="checkbox"/> white	96,95 €

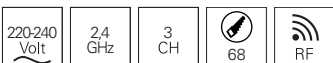

DEKO-LIGHT WALL TOUCH PANEL RF COLOR & WHITE

- control of the controller via radio, no additional control lines necessary
- for controlling RGB + white LED stripes / luminaires
- 4 zones
- independent dimming of individual zones
- all zones can be switched on/off together
- 12 effect programs
- adjustable programme speed
- memory function
- dimensions L x W x H: 86,5 x 86,5 x 31,1 mm

item	colour	price
843021	<input type="checkbox"/> white	96,95 €

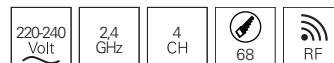

accessories for 843020

843066 controller **96,95 €**

accessories for 843021

843067 controller **96,95 €**

DMX controller		max. number of zones	DMX channels per zone	1-channel-modus [single]	2-channel-modus [CW-WW]	3-channel-modus [RGB]	4-channel-modus [RGBW]	5-channel-modus [RGBW-A]	6-channel-modus [RGB-CW-WW-A]
843005 TC-2 	wall controller for dimming of 1-DMXchannel with 4 programmable keys	1	1	yes	-	-	-	-	-
843000 Art-4 RGB/RGBW 	controller can next to 4-channel RGBW also for 3-channel RGB components used become	1	3/4	-	-	yes	yes	-	-
843003 Art-9 RGB/RGBW 	controller can next to 4-channel RGBW also for 3-channel RGB components used become	1	3/4	-	-	yes	yes	-	-
843004 Touch 16CH Pro 	the 4 zones of the controller can be any be mixed [1- / 2- / 3- / 4-channel]	4	1-4	yes [zone-mix available]	yes [zonemix available]	yes [zonemix available]	yes [zonemix available]	-	-
861203 X-Fade-6 II 	simple wall controller for the simple and manual Dimming from up to 6 DMX channels	-	1-6	yes	manual regulati-on [max. 3x 2 CH]	manual regulati-on [max. 2x 3 CH]	manual regulati-on [max. 1x 4 CH]	-	-
843001 Touch 16C 	wall controller for controlling up to 16 DMX channels	4	1-4	yes [max. 16x 1 CH]	manual colour-setting [max. 8x 2 CH]	manual colour-setting [max. 4x 3 CH]	manual colour-setting [max. 4x 4 CH]	-	-
843046 LED EASY Operator 	comfotable controller with programmable keys, programs ideal for gastronomy, events and more comprehensive installations	4	1-6	yes [max. 4x 1 CH]	yes [max. 4x 2 CH]	yes [max. 4x 3 CH]	yes [max. 4x 4 CH]	yes [max. 4x 5 CH]	yes [max. 4x 6 CH]
843047 LED Color Chief 	top controller with programmable keys, programs and USB backup ideal for gastronomy, events and more comprehensive installations	8	1-6	yes [max. 8x 1 CH]	yes [max. 8x 2 CH]	yes [max. 8x 3 CH]	yes [max. 8x 4 CH]	yes [max. 8x 5 CH]	yes [max. 8x 6 CH]

DMX dimmer		available channel mode	compatible with 1-channel-controllers	compatible with 2-channel-controllers	compatible with 3-channel-controllers	compatible with 4-channel-controllers	compatible with 5-channel-controllers	compatible with 6-channel-controllers	flicker free
843336 LED Dimmer 2 	simple DMX dimmer with high PWM rate [deployment in areas, in those filmed will]	1/2	yes	yes	-	-	-	-	yes
843268 OLED Dimmer 3 	just about display, internal car programs or manual control system even without a controller, simple DMX installation through CAT5 cable	1/3	yes	-	yes	-	yes [required two times]	yes [required two times]	-
843335 LED Dimmer 3 	simple DMX dimmer with high PWM rate [deployment in areas, in those filmed will]	3	-	-	yes	-	yes [required two times]	yes [required two times]	yes
843269 OLED Dimmer 4 	just about display, internal car programs or manual control system even without a controller, simple DMX installation through CAT5 cable	1/2/4	yes	yes	-	yes	-	-	-
843337 LED Dimmer 4 	simple DMX dimmer with high PWM rate [deployment in areas, in which will be filmed]	4	-	-	yes	yes	-	-	yes
843273 Dimmer R-DMX 3+1 	DMX dimmer with remote configuration possibility [R-DMX] especially for the events sector	3/4	-	-	yes	yes	-	-	-
843060 LED-Dimmer DMX, R-DMX 	DMX dimmer 12-48V, addressing via DIP switches	1/3/4	yes	yes	yes	yes	yes [required two times]	yes [required two times]	yes
843054 LED-Dimmer DMX für [CC] stromstabile luminares 	DMX dimmer 24-50V, 4x60W, programming via display	1/2/3/4	yes	yes	yes	yes	yes [required two times]	yes [required two times]	yes



DEKO-LIGHT CONTROLLER TC-2

The TC-2 controller is a touch panel, allowing the storage and retrieval of up to 4 storage locations. Scenes and atmospheres are created quickly in a user-friendly manner with the aid of the intuitive controller. It suits both hotels and auditoriums, as well as the home and living space.

- touch interface
- optional DMX512 or analogous 0-10V
- fade time setting from 0.01 to 10s
- dimming steps 0-100%
- LED Display
- 4 storage locations
- DMX out / DC in / 0-10V out: connection terminals
- dimensions L x W x H: 86 x 86 x 15,3 mm

item	colour	price
843005	■ black	199,95 €



accessories

872128 power supply Mini 24V/4W

13,95 €



DEKO-LIGHT X-FADE-6

The X-Fade 6 is a modern wall controller on the DMX basis for LED dimmers. Up to 6 faders can be directly controlled and connected to RGB dimmers. For example, 2 RGB stripes are addressed and also 6 single one-colour stripes can be controlled in 6 different zones. The X-Fade 6 is further used as a standard 6 channel DMX Controller, which enables the control of DMX dimmers or devices with up to 6 channels. Additionally, up to 6 different programs can be retrieved. Each program can contain up to 100 steps. Programs can also be controlled automatically. [A mounting box is required for the assembly of the controller.]

- incl. IR-remote control
- 6 programmable scenes
- fade time setting
- DMX out / DC in: connection terminals
- dimensions L x W x H: 86 x 86 x 16,3 mm

item	colour	price
861203	■ black	199,95 €



accessories

872128 power supply Mini 24V/4W

13,95 €

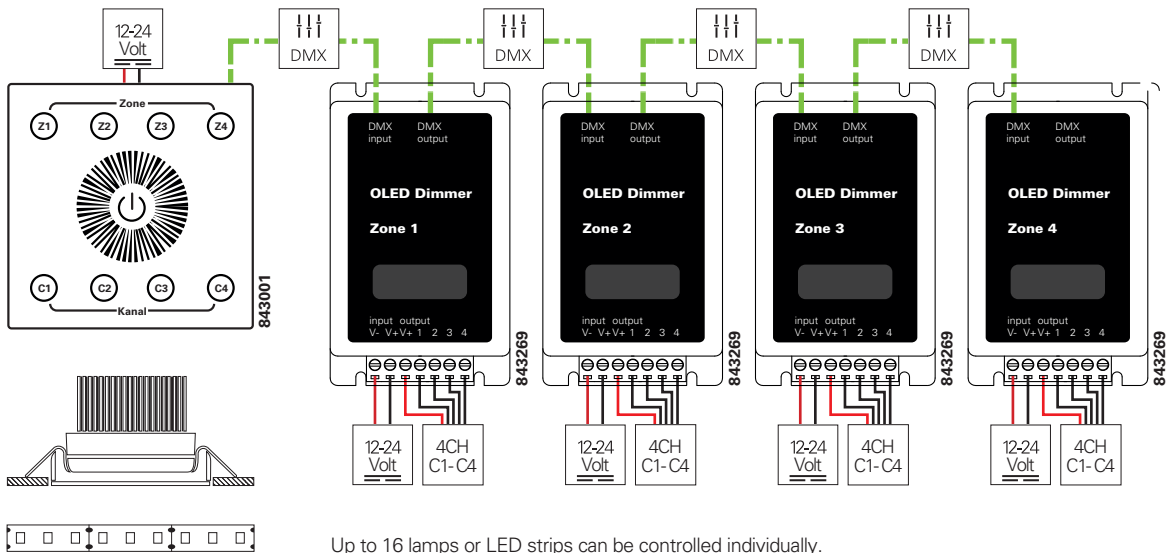

DEKO-LIGHT LED DMX TOUCH 16C

The LED DMX TOUCH 16C is provided with 4 zones with 4 channels each. In total, 16 single channels are available. At the selection of one of the zones (Z1-Z4), the touchwheel controls all 4 channels of this zone. At the selection of one channel (C1-C4) in one zone, the touchwheel controls this selected channel. If neither a zone nor a channel is selected, the touchwheel controls all zones, including their channels. Please note that the controller was specifically designed for warm and/or cold white end devices. By its functions, it is only conditionally implemented for RGB or RGBW end devices.



- background illumination and touch signal tone optionally connectable
- memory function: the DMX Touch 16C memorizes the most recent brightness setting of all zones and channels
- DMX out: CAT5 [RJ45] opt. connection terminals
- dimensions L x W x H: 86 x 86 x 17,4 mm

item colour price

843001 ■ black **129,95 €**

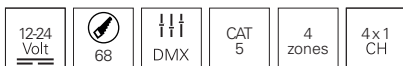

accessories

872128 power supply Mini 24V/4W

13,95 €



DEKO-LIGHT ART 4 | RGB/RGBW

The ART 4 controller is a touch panel for playing and editing colour programs, specifically for RGBW end devices. Up to 4 atmospheres and up to 4 scenes can be saved and retrieved. The ART-4 contains 4 function menus: Selection of integrated programs, colour, brightness, speed setting. Scenes and atmospheres are created in a quick and userfriendly manner. As a design element, the ART 4 controller is ideally suited in the environment and is an appropriate choice both for hotels and auditoriums and the home and living space.

- PWM out for the direct control of LED stripes
- control element and controller via touchwheel
- fade times of 0-4 seconds possible
- DMX out / DC in: connection terminals
- dimensions L x W x H: 86 x 86 x 15,3 mm
- integrated PWM dimmer 12/24V, 4 x 2A

item	colour	price
843000	■ black	229,95 €



DEKO-LIGHT ART 9 | RGB/RGBW

The ART 9 controller is a touch panel for playing and editing colour programs, specifically for RGBW end devices. Up to 9 atmospheres and up to 9 scenes can be saved and retrieved. The ART-4 contains 4 function menus: Selection of integrated programs, colour, brightness, speed setting. Scenes and atmospheres are created in a quick and userfriendly manner. As a design element, the ART 9 controller is ideally suited in the environment and is an appropriate choice both for hotels and auditoriums and the home and living space.

- PWM out for the direct control of LED stripes
- control element and controller via touchwheel
- fade time setting for switch on/off and colour change
- function memory and power failure protection
- DMX out / DC in: connection terminals
- dimensions L x W x H: 172 x 86 x 15,3 mm
- integrated PWM dimmer 12/24V, 4 x 2A

item	colour	price
843003	■ black	234,95 €



accessories

872128 power supply Mini 24V/4W **13,95 €**

accessories

872128 power supply Mini 24V/4W **13,95 €**



DEKO-LIGHT TOUCH 16CH PRO

The Touch 16CH Pro controller is a touch panel, allowing the storage and retrieval of up to 4 zones with 4 channels each. Scenes and atmospheres are created quickly in a userfriendly manner with the aid of the intuitive controller. It suits both hotels and auditoriums, as well as the home and living space. As a design element, the Touch 16Ch Pro is ideally implemented in the living space.

- colour mode for setting the colours in each individual zone
- program mode for the colour change and fader setting for each zone
- time mode for setting the start and end time of the programs
- 14 pre-installed or 8 auto-created programs can be assigned to one scene
- internal clock to switch the zones time-dependently with the saved programs
- DMX out / DC in: connection terminals
- dimensions L x W x H: 86 x 86 x 15,3 mm

item	colour	price
843004	 black	359,95 €

 12-24 Volt	 68	 DMX	 4 zones	 1-4 CH
--	--	---	---	--

accessories

872128	power supply Mini 24V/4W	13,95 €
---------------	--------------------------	----------------



EUROLITE DMX-CONTROLLER LED COLOR CHIEF

The COLOR CHIEF is an innovative and easy to use DMX controller, which is optimally tailored to the needs and requirements of gastronomy, bars, event locations, event rooms, etc. . It is suitable for controlling e. g. LED stripes, lights, spotlights, light effects and all other components with 1-6 colours [WW, CW, WW-CW, RGB, RGBW, RGB-

WAUV] or up to 30 channels, which can be controlled with DMX via corresponding controller/dimmer. 24 different and directly selectable scene buttons allow access to previously stored lighting scenes or program sequences. The USB interface can be used to save the created programming to a USB memory stick and, if necessary, to restore it.

- easy control of LED stripes, lights, headlights or similar with 1-6 colors or simple lighting effects with up to 30 channels
- for up to 8 different device groups/zones
- fast and easy programming
- extensive, already pre-installed device library with many common applications
- additional devices can be easily added manually
- 8 colour effects directly selectable
- three additional channels are freely assignable per device [e.g. for special functions, movements, etc.]
- colour wheel selection
- 24 memory slots for permanently stored lighting moods
- USB port for data storage / restoration of programming
- clock control with programmed chases via music signal
- total dimming, fade time between individual scenes comfortably adjustable
- 3-pin XLR connector
- firmware-Update via USB
- operation as rack installation [19 "/ 3 height units] or desktop unit
- control: DMX / max. 240 channels
- power supply: power cable with power adapter [included]
- weight: 2,2 kg
- protection class: IP20
- connection power: 10 W
- dimensions L x W x H: 483 x 132 x 85 mm

item	colour	price
843047	■ black	419,95 €



accessories

882271	adapter DMX plug to CAT5	54,95 €
---------------	--------------------------	----------------

752 CONTROLLER | DMX controller



EUROLITE DMX-CONTROLLER LED EASY DELUXE

The LED EASY DELUXE is a very simple and intuitive DMX controller that can be used for a wide range of applications. No matter if commercial or private, wherever LED stripes, lights, spotlights with 1-6 colours [WWW, CW, WWW-CW, RGB,

RGBW, RGBW-A-UV] and DMX are controlled via corresponding controller/dimmer, this new DXM controller finds its application. It is very easy to directly select 12 different stored light moods/scenes using a rotary control.

- easy control of LED stripes, lamps, spotlights etc. with 1-6 colours
- for up to 4 different device groups/zones
- quick and easy commissioning thanks to pre-installed programs
- single DMX channels for red, green, blue, white, amber and UV
- 12 memory slots for permanently stored lighting moods
- 4 colour controls with 12 colours each
- 4 brightness controls
- function buttons for blackout, auto, music control and strobe effect
- fader for overall brightness, sequence and fade time
- 3-pin XLR connector
- operation as a tabletop device or built-in device
- control: DMX / max. 24 channels
- power supply: power cable with power adapter [included]
- weight: 1,2 kg
- protection class: IP20
- connection power: 10 W
- dimensions L x W x H: 260 x 140 x 65 mm

item	colour	price
843046	■ black	199,95 €

100-240 Volt	DMX	4 zones	16 CH
-----------------	-----	------------	----------

accessories

882271	adapter DMX plug to CAT5	54,95 €
---------------	--------------------------	----------------

DEKO-LIGHT OLED DMX DIMMER 3

**3 channel all-in-one PWM dimmer
with 3 different operating modes:**

- **DMX control**
- **standalone Programme mode**
- **standalone dimmer mode**
- to be used as a 1 or 3 channel dimmer
- a manual mode allows the single dimming of the 3 channels on the device [colour setting]
- incl. 27 colour change programs
- master/slave function
- all settings are retrieved via a simple menu on a LCD display
- DMX signal pluggable via CAT5 [2m patch cable included in delivery]
- dimensions L x W x H: 116 x 57 x 23,8 mm
- max. 6A each channel
- power: 3x 72W [216W] at 12V,
3x 144W [432W] at 24V



item	colour	price
843268	■ black	109,95 €



DEKO-LIGHT OLED DMX DIMMER 4

**4 channel all-in-one PWM dimmer
with 3 different operating modes:**

- **DMX control**
- **standalone Programme mode**
- **standalone dimmer mode**
- to be used as a 1, 2 or 4 channel dimmer
- a manual mode allows the single dimming of the 4 channels on the device [colour setting]
- incl. 13 colour change programs
- master/slave function
- all settings are retrieved via a simple menu on a LCD display
- DMX signal pluggable via CAT5 [2m patch cable included in delivery]
- dimensions L x W x H: 116 x 57 x 23,8 mm
- max. 6A each channel
- power: 4x 60W [240W] at 12V,
4x 120W [480W] at 24V



item	colour	price
843269	■ black	124,95 €



DEKO-LIGHT LED DMX DIMMER 2

- simple and powerful 1-2 channel dimmer
- to be used as a single device or in connection with a control panel in an assembly
- flicker free
- connection: screw terminals
- control: DMX, 0-10V, manual, automatic
- dimensions L x W x H: 115 x 57 x 25 mm
- max. 6A each channel
- power: 2x 72W [144W] at 12V,
2x 144W [288W] at 24V



item	colour	price
843336	■ black	79,95 €



DEKO-LIGHT LED DMX DIMMER 3

- simple and powerful 3 channel dimmer
- to be used as a single device or in connection with a control panel in an assembly
- flicker free
- connection: screw terminals
- control: DMX, manual, automatic
- dimensions L x W x H: 115 x 57 x 25 mm
- max. 4A each channel
- power: 3x 48W [144W] at 12V,
3x 96W [288W] at 24V



item	colour	price
843335	■ black	82,95 €



DEKO-LIGHT LED DMX DIMMER 4

- simple and powerful 4 channel dimmer
- to be used as a single device or in connection with a 4 channels DMX wall controller
- flicker free
- connection: screw terminals
- control: DMX, manual, automatic
- dimensions L x W x H: 115 x 57 x 25 mm
- max. 3A each channel
- power: 4x 36W [144W] at 12V,
4x 72W [288W] at 24V



item	colour	price
843337	■ black	86,95 €



DEKO-LIGHT R-DMX 3+1

RDM means »Remote Device Management«. This remote device management enables the control of the RDMX 3+1 from the control panel. This provides a great advantage, specifically for inaccessible installations or sites that are difficult to reach. If RDM is not available, the DMX address assignment can also be set manually via the DIP switch.

- complies with the DMX 512/1990, RDM protocol/2009
- supports automatic DMX addressing
- incl. top-hat rail adapter
- incl. 2m CAT5 cable [RJ45]
- flicker free
- connection: screw terminals
- dimensions L x W x H: 120 x 43 x 23 mm
- max. 4A each channel
- power: 4x 48W [192W] at 12V,
4x 96W [384W] at 24V



item	colour	price
843273	■ black	89,95 €



DEKO-LIGHT 4 CHANNEL LED DMX DIMMER 12-48V

- simple and powerful 4 channel dimmer
- RDM capable with compatible controllers [remote configuration, e.g. DMX address]
- use in conjunction with DMX wall controller or DMX512 PC software
- flicker free
- connection DMX in/out: CAT5 or screw terminals
- connection DC in/out: screw terminals
- dimensions L x W x H: 140 x 50 x 26 mm
- max. 4A each channel
- power: 4x 48W [192W] at 12V,
4x 96W [384W] at 24V,
4x 192W [768W] at 48V



item	colour	price
843060	■ black	96,95 €



POWER SUPPLY WITH INTEGRATED 3-CHANNEL DMX DIMMER

- compact DMX combi device for simple and quick installation
- powerful 3 channel dimmer and power supply combined in one housing
- controlled with all 3 channels DMX control panels
- supports DMX512
- dimmable from 0 - 100%
- soft dimming without flickering
- dimensions L x W x H: 196 x 75 x 40 mm
- power: 3x 45W



item	colour	power	price
843274	■ black	12V 135 W	194,95 €
843275	■ black	24V 135 W	194,95 €



DEKO-LIGHT LED DMX/R-DMX DIMMER 4 CC

- controls 4 independent constant current [CC] LED-luminaires via all common DMX and RDM DMX controllers
- constant current for each channel individually adjustable from 200 - 1600 mA in 50 mA steps
- output voltage for CC-compatible luminaires: 1 - 42V
- all settings via a simple menu via OLED display
- flicker free
- short-circuit proof and overload protection
- connection: screw terminals
- dimensions L x W x H: 135 x 69 x 36 mm
- power: max. 4x 60W



item	colour	price
843054	■ black	119,95 €





DALI LED PWM-DIMMER 1/2 CHANNEL

- for controlling 1-2 channel LED stripes [single, WW/CW components]
- dimmable via Dali Bus according to IEC 62386 / Device Type DT6
- overload / short circuit indication / switch-off
- dimensions L x W x H: 167 x 51 x 23 mm
- max. 5A each channel
- power: 2x 120W (240W) at 12 V,
2x 240W (480W) at 24 V

item	colour	price
843051	<input type="checkbox"/> white	109,95 €

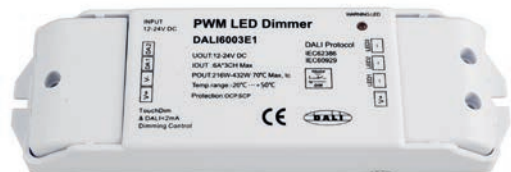

DALI LED PWM-DIMMER 3 CHANNEL

- for controlling 3 channel LED stripes [RGB components]
- dimmable via Dali Bus according to IEC 62386 / Device Type DT6
- overload / short circuit indication / switch-off
- dimensions L x W x H: 167 x 51 x 23 mm
- max. 6A each channel
- power: 3x 72W (216W) at 12 V,
3x 144W (432W) at 24 V

item	colour	price
843052	<input type="checkbox"/> white	114,95 €





DALI LED PWM-DIMMER 4 CHANNEL

- for controlling 1-4 channel LED stripes [single, WW/CW, RGB, RGBW components]
- dimmable via Dali Bus according to IEC 62386 / Device Type DT6
- overload / short circuit indication / switch-off
- dimensions L x W x H: 167 x 51 x 23 mm
- max. 5A each channel
- power: 4x 60W (240W) at 12V,
4x 120W (480W) at 24V

item	colour	price
843010	<input type="checkbox"/> white	129,95 €

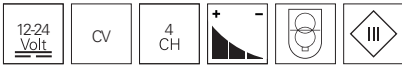

With the kind support of SH-Lichttechnik, Pfullingen und Becks Reutlingen





ILLUMINANTS

- 764 G4
- 764 AR111
- 765 MR16/GU5,3
- 766 G9
- 767 GU10
- 768 GU10/ES111
- 769 E14
- 770 E27
- 774 R7s
- 774 GX53
- 775 neon tubes
- 776 metal vapour lamps



G4
page 764



G4
page 764



G53 QR111
page 764



MR16/GU5,3
page 765



MR16/GU5,3
page 765



G9
page 766



G9
page 766



GU10
page 767



GU10
page 767



GU10
page 767



GU10
page 768



GU10/ES111
page 768



E14
page 769



E14
page 769



E14
page 769



E27
page 770



E27
page 770



E27
page 770



E27
page 771



E27
page 771



E27
page 771



E27
page 772



E27
page 772



E27
page 773



E27
page 773



R7S
page 774



R7S
page 774



GX53
page 774



neon tubes
page 775



neon tubes
page 775



metal vapour
lamps
page 776



metal vapour
lamps
page 776



metal vapour
lamps
page 776



metal vapour
lamps
page 777

illuminants

OSRAM PARATHOM LED PIN G4

- plastic
- dimensions L x Ø: 36 x 13 mm



item	colour	colour temp.	light current	power	equivalent to	beam angle	EEL energy consumption	price
180213	<input checked="" type="checkbox"/> colourless	2700 K	200 lm	1,8 W	20 W	320°	F 2 kWh/1000h	8,95 €



PHILIPS COREPRO LEDCAPSULE G4

- plastic
- dimensions L x Ø: 40 x 15 mm



item	colour	colour temp.	light current	power	equivalent to	beam angle	EEL energy consumption	price
180193	<input type="checkbox"/> silver	2700 K	315 lm	2,7 W	28 W	300°	F 3 kWh/1000h	18,95 €



OSRAM PARATHOM PRO AR111 DIMMABLE

- plastic
- dimensions L x Ø: 55 x 111 mm



item	colour	colour temp.	light current	power	equivalent to	beam angle	EEL energy consumption	price
180207	<input type="checkbox"/> grey	2700 K	450 lm	7,4 W	35 W	24°	G 8 kWh/1000h	36,95 €
180206	<input type="checkbox"/> grey	3000 K	450 lm	7,4 W	35 W	24°	G 8 kWh/1000h	36,95 €





OSRAM PARATHOM MR16

- glass
- dimensions L x Ø: 46 x 51 mm

item	colour	colour temp.	light current	power	equivalent to	beam angle	EEL energy consumption	price
180167	<input checked="" type="checkbox"/> colourless	3000 K	230 lm	2,6 W	20 W	36°	G 3 kWh/1000h	7,95 €
180183	<input checked="" type="checkbox"/> colourless	4000 K	230 lm	2,6 W	20 W	36°	G 3 kWh/1000h	7,95 €
180177	<input checked="" type="checkbox"/> colourless	3000 K	350 lm	3,8 W	35 W	36°	F 5 kWh/1000h	8,95 €
180175	<input checked="" type="checkbox"/> colourless	4000 K	350 lm	3,8 W	35 W	36°	F 5 kWh/1000h	8,95 €



OSRAM PARATHOM MR16 DIMMABLE

- glass
- dimensions L x Ø: 46 x 51 mm

item	colour	colour temp.	light current	power	equivalent to	beam angle	EEL energy consumption	price
180176	<input checked="" type="checkbox"/> colourless	3000 K	230 lm	3,4 W	20 W	36°	G 4 kWh/1000h	10,95 €
180197	<input checked="" type="checkbox"/> colourless	4000 K	230 lm	3,4 W	20 W	36°	G 4 kWh/1000h	10,95 €
180168	<input checked="" type="checkbox"/> colourless	3000 K	350 lm	4,9 W	35 W	36°	G 6 kWh/1000h	11,95 €
180174	<input checked="" type="checkbox"/> colourless	4000 K	350 lm	4,9 W	35 W	36°	G 6 kWh/1000h	11,95 €
180219	<input checked="" type="checkbox"/> colourless	3000 K	621 lm	8,0 W	50 W	36°	G 9 kWh/1000h	16,95 €





OSRAM HALOPIN G9

- glass
- dimensions L x Ø: 43 x 14 mm

item	colour	colour temp.	light current	power	beam angle	EEl energy consumption	price
666663	colourless	3000 K	235 lm	20 W	360°	G 20 kWh/1000h	3,95 €
666662	colourless	4000 K	460 lm	33 W	360°	G 33 kWh/1000h	3,95 €
666664	colourless	3000 K	740 lm	48 W	360°	G 48 kWh/1000h	3,95 €



OSRAM P PIN G9

- plastic

item	colour	colour temp.	light current	power	equivalent to	beam angle	EEl	energy cons.	dimensions L x Ø	price
180202	colourless	2700 K	200 lm	1,9 W	20 W	360°	F	2 kWh/1000h	46 x 15 mm	7,95 €
180236	colourless	2700 K	320 lm	2,6 W	30 W	360°	E	3 kWh/1000h	47 x 15 mm	9,95 €
180237	colourless	2700 K	470 lm	4,2 W	40 W	360°	E	5 kWh/1000h	52 x 19 mm	12,95 €



OSRAM PARATHOM GU10

- glass
- dimensions L x Ø: 52 x 50 mm



item	colour	colour temp.	light current	power	equivalent to	beam angle	EEl energy consumption	price
180203	<input type="checkbox"/> silver	ww 2700 K	350 lm	4,3 W	50 W	36°	F 5 kWh/1000h	5,95 €



PHILIPS MASTER VALUE GU10 DIMMABLE

- glass
- dimensions L x Ø: 54 x 50 mm



item	colour	colour temp.	light current	power	equivalent to	beam angle	EEl	energy cons.	price
180209	<input type="checkbox"/> silver	ww 2700 K	270 lm	3,7 W	35 W	36°	F	4 kWh/1000h	12,95 €
180208	<input type="checkbox"/> silver	ww 2700 K	355 lm	4,8 W	50 W	36°	F	5 kWh/1000h	13,95 €
180049	<input type="checkbox"/> silver	ww 2700 K	355 lm	4,9 W	50 W	60°	F	5 kWh/1000h	13,95 €
180099	<input type="checkbox"/> silver	ww 3000 K	365 lm	4,9 W	50 W	36°	F	5 kWh/1000h	13,95 €
180050	<input type="checkbox"/> silver	ww 3000 K	365 lm	4,9 W	50 W	60°	F	5 kWh/1000h	13,95 €
180053	<input type="checkbox"/> silver	nw 4000 K	380 lm	4,9 W	50 W	36°	F	5 kWh/1000h	13,95 €
180051	<input type="checkbox"/> silver	nw 4000 K	380 lm	4,9 W	50 W	60°	F	5 kWh/1000h	13,95 €
180139	<input type="checkbox"/> silver	ww 3000 K	575 lm	6,2 W	80 W	36°	F	7 kWh/1000h	18,95 €
180149	<input type="checkbox"/> silver	nw 4000 K	575 lm	6,2 W	80 W	36°	F	7 kWh/1000h	18,95 €



OSRAM PARATHOM GU10 DIMMABLE

- glass
- dimensions L x Ø: 52 x 50 mm



item	colour	colour temp.	light current	power	equivalent to	beam angle	EEl	energy cons.	price
180204	<input type="checkbox"/> silver	ww 2700 K	575 lm	8,3 W	80 W	36°	G	9 kWh/1000h	12,95 €





PHILIPS MASTER VALUE DT GU10 DIM-TO-WARM

- glass
- dimensions L x Ø: 54 x 50 mm
- dtw: dimming changes the colour temperature from 2700 to 2000 K

item	colour	colour temp.	light current	power	equivalent to	beam angle	EEl energy consumption	price
180212	silver	ww 2000-2700 K	270 lm	3,7 W	35 W	36°	F 4 kWh/1000h	17,95 €
180113	silver	ww 2000-2700 K	355 lm	4,9 W	50 W	36°	F 5 kWh/1000h	18,95 €

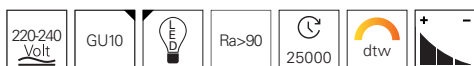

ISOLED ES111 COB SPOT GU10 DIMMABLE

- glass
- dimensions L x Ø: 63,5 x 111 mm

item	colour	colour temp.	light current	power	equivalent to	beam angle	EEl energy consumption	price
180166	silver	ww 2700 K	1050 lm	13 W	75 W	75°	D 14 kWh/1000h	79,95 €
180163	silver	nw 4200 K	1400 lm	13 W	100 W	75°	E 14 kWh/1000h	79,95 €





PHILIPS COREPRO LEDCANDLE E14

- glass
- dimensions L x Ø: 97 x 35 mm

item	colour	colour temp.	light current	power	equivalent to	beam angle	EEL energy consumption	price
180238	<input type="checkbox"/> milky	<input checked="" type="checkbox"/> 2700 K	470 lm	4,3 W	40 W	360°	F 5 kWh/1000h	8,45 €



PHILIPS CLASSIC LEDCANDLE E14 DIM-TO-WARM

- glass
- dimensions L x Ø: 97 x 35 mm
- dtw: dimming changes the colour temperature from 2700 to 2000 K

item	colour	colour temp.	light current	power	equivalent to	beam angle	EEL energy consumption	price
180199	<input checked="" type="checkbox"/> colourless	<input checked="" type="checkbox"/> 2200-2700 K	470 lm	3,4 W	40 W	270°	D 4 kWh/1000h	12,95 €

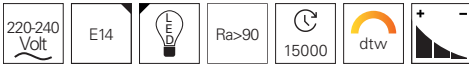

PHILIPS MASTER LEDLUSTRE E14 DIM-TO-WARM

- dimensions L x Ø: 95 x 50 mm
- dtw: dimming changes the colour temperature from 2700 to 2000 K

item	colour	colour temp.	light current	power	equivalent to	beam angle	EEL energy consumption	price
180216	<input checked="" type="checkbox"/> colourless	<input checked="" type="checkbox"/> 2200-2700 K	470 lm	5,5 W	40 W	270°	F 6 kWh/1000h	14,95 €





PHILIPS MASTER LEDSPOT E27 PAR 30 DIMMABLE

- glass
- dimensions L x Ø: 88 x 96 mm

item	colour	colour temp.	light current	power	equivalent to	beam angle	EEl energy consumption	price
180179	<input checked="" type="checkbox"/> colourless	ww 3000 K	760 lm	9,5 W	80 W	25°	F 10 kWh/1000h	41,95 €
180187	<input checked="" type="checkbox"/> colourless	nw 4000 K	820 lm	9,5 W	80 W	25°	F 10 kWh/1000h	41,95 €



PHILIPS CLASSIC LEDLUSTER E27 P45 DIM-TO-WARM

- glass
- dimensions L x Ø: 78 x 45 mm
- dtw: dimming changes the colour temperature from 2700 to 2000 K

item	colour	colour temp.	light current	power	equivalent to	beam angle	EEl energy consumption	price
180198	<input checked="" type="checkbox"/> colourless	ww 2200-2700 K	340 lm	2,5 W	25 W	270°	D 3 kWh/1000h	11,95 €
180194	<input checked="" type="checkbox"/> colourless	ww 2200-2700 K	470 lm	3,5 W	40 W	270°	D 4 kWh/1000h	12,95 €

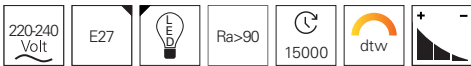

DEKO-LIGHT LED FILAMENT E27 A60 DIMMABLE

- glass
- dimensions L x Ø: 105 x 60 mm

item	colour	colour temp.	light current	power	equivalent to	beam angle	EEl energy consumption	price
180055	<input type="checkbox"/> milky	ww 2700 K	410 lm	4,4 W	40 W	300°	F 5 kWh/1000h	6,95 €





PHILIPS COREPRO LEDBULB E27 A60 DIMMABLE

- glass
- dimensions L x Ø: 104 x 60 mm

item	colour	colour temp.	light current	power	equivalent to	beam angle	EEL energy consumption	price
180214	<input type="checkbox"/> milky	<input checked="" type="checkbox"/> 2700 K	470 lm	3,4 W	40 W	150°	D 4 kWh/1000h	11,95 €



OSRAM PARATHOM RETROFIT E27 A60 DIMMABLE

- glass
- dimensions L x Ø: 105 x 60 mm

item	colour	colour temp.	light current	power	equivalent to	beam angle	EEL energy consumption	price
180205	<input checked="" type="checkbox"/> colourless	<input checked="" type="checkbox"/> 2700 K	806 lm	6,5 W	60 W	360°	E 7 kWh/1000h	8,45 €



OSRAM PARATHOM CLASSIC E27 A75 DIMMABLE

- glass
- dimensions L x Ø: 105 x 60 mm

item	colour	colour temp.	light current	power	equivalent to	beam angle	EEL energy consumption	price
180239	<input type="checkbox"/> milky	<input checked="" type="checkbox"/> 2700 K	1055 lm	7,5 W	75 W	300°	D 8 kWh/1000h	9,95 €





DEKO-LIGHT LED FILAMENT E27 G95 DIMMABLE

- glass
- dimensions L x Ø: 140 x 95 mm

item	colour	colour temp.	light current	power	equivalent to	beam angle	EEL energy consumption	price
180058	colourless	2700 K	450 lm	4,4 W	40 W	300°	F 5 kWh/1000h	10,95 €
180059	<input type="checkbox"/> milky	2700 K	410 lm	4,4 W	40 W	300°	F 5 kWh/1000h	10,95 €
180060	gold optics	2200 K	380 lm	4,4 W	40 W	300°	F 5 kWh/1000h	11,95 €
180061	colourless	2700 K	1010 lm	8,5 W	100 W	300°	F 9 kWh/1000h	13,95 €
180062	<input type="checkbox"/> milky	2700 K	930 lm	8,5 W	100 W	300°	F 9 kWh/1000h	13,95 €
180063	gold optics	2200 K	860 lm	8,5 W	100 W	300°	F 9 kWh/1000h	14,95 €



DEKO-LIGHT LED FILAMENT E27 G125 DIMMABLE

- glass
- dimensions L x Ø: 173 x 125 mm

item	colour	colour temp.	light current	power	equivalent to	beam angle	EEL energy consumption	price
180064	colourless	2700 K	450 lm	4,4 W	40 W	300°	F 5 kWh/1000h	11,95 €
180065	<input type="checkbox"/> milky	2700 K	410 lm	4,4 W	40 W	300°	F 5 kWh/1000h	11,95 €
180066	gold optics	2200 K	380 lm	4,4 W	40 W	300°	F 5 kWh/1000h	12,95 €
180067	colourless	2700 K	1010 lm	8,5 W	100 W	300°	E 9 kWh/1000h	15,95 €
180068	<input type="checkbox"/> milky	2700 K	930 lm	8,5 W	100 W	300°	F 9 kWh/1000h	15,95 €
180069	gold optics	2200 K	860 lm	8,5 W	100 W	300°	F 9 kWh/1000h	16,95 €





DEKO-LIGHT LED FILAMENT E27 ST64 DIMMABLE

- glass
- dimensions L x Ø: 145 x 64 mm

item	colour	colour temp.	light current	power	equivalent to	beam angle	EEL energy consumption	price
180070	gold optics	2200 K	380 lm	4,4 W	40 W	300°	F 5 kWh/1000h	10,95 €
180071	gold optics	2200 K	860 lm	8,5 W	100 W	300°	F 9 kWh/1000h	14,95 €



DEKO-LIGHT LED E27 RF RGBW MIT REMOTE CONTROL

- aluminium diecast
- dimensions L x Ø: 120 x 60 mm
- dimmable / colours adjustable via radio remote control

item	colour	colour temp.	light current	power	equivalent to	EEL energy consumption	price
180136	silver	3000 K	520 lm	8 W	60 W	A 8 kWh/1000h	54,95 €





OSRAM HALOLINE R7S 78MM DIMMABLE

- glass
- dimensions L x Ø: 74,9 x 12 mm

item	colour	colour temp.	light current	power	beam angle	EEl	energy consumption	price
332269	colourless	2800 K	750 lm	48W	360°	C	48 kWh/1000h	7,95 €
332270	colourless	2950 K	1400 lm	80W	360°	D	80 kWh/1000h	7,95 €
332271	colourless	2950 K	2250 lm	120W	360°	C	120 kWh/1000h	7,95 €



PHILIPS COREPRO LED R7S 118MM DIMMABLE

- plastic
- dimensions L x Ø: 118 x 29 mm

item	colour	colour temp.	light current	power	equivalent to	beam angle	EEl energy consumption	price
180097	silver	3000 K	1600 lm	14W	100 W	360°	E 14 kWh/1000h	43,95 €



ISOLED LED GX53

- plastic
- dimensions L x Ø: 28 x 75 mm

item	colour	colour temp.	light current	power	equivalent to	beam angle	EEl energy consumption	price
180196	white	3000 K	500 lm	6W	35 W	120°	D 6 kWh/1000h	19,95 €
180195	white	4000 K	525 lm	6W	35 W	120°	D 6 kWh/1000h	19,95 €



OSRAM NEON TUBES T5

- glass
- acceptance only in whole unit of 20 pcs. per wattage
- electronic ballast required!



item	colour	colour temp.	light current	power	beam angle	EEl	energy consumption	dimensions L	price
162054	<input type="checkbox"/> milky	NW 4000 K	1200 lm	14W	360°	G	16 kWh/1000h	549 mm	4,45 €
162055	<input type="checkbox"/> milky	NW 4000 K	4450 lm	54W	360°	F	60 kWh/1000h	1149 mm	5,45 €

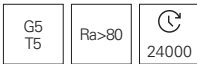

OSRAM NEON TUBES T8 PLUS

- glass
- acceptance only in whole unit of 25 pcs. per wattage
- electronic ballast required!



item	colour	colour temp.	light current	power	beam angle	EEl	energy consumption	dimensions	price
162047	<input type="checkbox"/> milky	NW 4000 K	1350 lm	18W	360°	G	20 kWh/1000h	590 mm	3,95 €
162044	<input type="checkbox"/> milky	CW 8000 K	1350 lm	18W	360°	G	20 kWh/1000h	590 mm	9,95 €
162048	<input type="checkbox"/> milky	NW 4000 K	5200 lm	58W	360°	G	64 kWh/1000h	1500 mm	4,95 €
162046	<input type="checkbox"/> milky	CW 8000 K	4900 lm	58W	360°	G	64 kWh/1000h	1500 mm	12,95 €

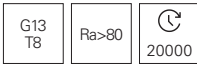

OSRAM HQI-TS POWERSTAR

- glass
- electronic ballast required!



item	colour	colour temp.	light current	power	beam angle	EEl	energy consumption	dimensions L x Ø	price
071WDL	colourless	3300 K	5925 lm	70 W	360°	G	70 kWh/1000h	117 x 19 mm	19,95 €
071NDL	colourless	4200 K	6500 lm	70 W	360°	G	70 kWh/1000h	117 x 19 mm	19,95 €
071DDL	colourless	5600 K	6200 lm	70 W	360°	G	70 kWh/1000h	117 x 19 mm	19,95 €
151WDL	colourless	3200 K	12000 lm	150 W	360°	G	150 kWh/1000h	135 x 23 mm	19,95 €
151NDL	colourless	4200 K	12500 lm	150 W	360°	G	150 kWh/1000h	135 x 23 mm	19,95 €
151DDL	colourless	5450 K	13000 lm	150 W	360°	G	150 kWh/1000h	135 x 23 mm	19,95 €



PHILIPS CDM-TD MASTERCOLOUR

- glass
- electronic ballast required!



item	colour	colour temp.	light current	power	beam angle	EEl	energy consumption	dimensions L x Ø	price
501011	colourless	4200 K	5600 lm	70 W	360°	G	70 kWh/1000h	119,5 x 22 mm	44,95 €
501012	colourless	3000 K	13250 lm	150 W	360°	G	150 kWh/1000h	137,4 x 25 mm	44,95 €
501013	colourless	4200 K	14200 lm	150 W	360°	G	150 kWh/1000h	137,4 x 25 mm	44,95 €



PHILIPS CDM-T MASTERCOLOUR

- glass
- electronic ballast required!



item	colour	colour temp.	light current	power	beam angle	EEl	energy consumption	dimensions L x Ø	price
501000	colourless	3000 K	3150 lm	35 W	360°	G	35 kWh/1000h	103 x 20 mm	39,95 €
501008	colourless	4200 K	3300 lm	35 W	360°	G	35 kWh/1000h	103 x 20 mm	39,95 €
501001	colourless	3000 K	6600 lm	70 W	360°	G	70 kWh/1000h	103 x 20 mm	39,95 €
501002	colourless	4200 K	6600 lm	70 W	360°	G	70 kWh/1000h	103 x 20 mm	39,95 €
501003	colourless	3000 K	14000 lm	150 W	360°	G	150 kWh/1000h	103 x 20 mm	41,95 €
501004	colourless	4200 K	12700 lm	150 W	360°	G	150 kWh/1000h	103 x 20 mm	41,95 €

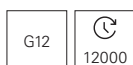



VENTURE HIT HALOGEN-METAL VAPOUR LAMP 250 W

- glass
- dimensions L x Ø: 245 x 46 mm
- electronic ballast required!

item	colour	colour temp.	light current	power	beam angle	EEL	energy consumption	price
501033	<input checked="" type="checkbox"/> colourless	nw 4500 K	18300 lm	250 W	360°	G	264 kWh/1000h	54,95 €

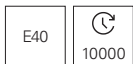

VENTURE HIT HALOGEN-METAL VAPOUR LAMP 400 W

- glass
- dimensions L x Ø: 296 x 46 mm
- electronic ballast required!

item	colour	colour temp.	light current	power	beam angle	EEL	energy consumption	price
501032	<input checked="" type="checkbox"/> colourless	nw 4000 K	41000 lm	400 W	360°	F	420 kWh/1000h	59,95 €





ACCESSORIES

- 782 indoor | dimming
- 784 indoor | dimming and switching
- 785 indoor | other
- 787 indoor | low voltage
- 788 indoor | low voltage | plug-in connector
- 791 outdoor | low voltage DC | WEIPU HQ plug-in connector
- 794 indoor / outdoor | DMX cable
- 796 indoor | high voltage
- 798 indoor | high voltage | plug systems
- 799 outdoor | high voltage | plug systems
- 801 outdoor | cable connectors
- 804 indoor / outdoor | mounting material for LED stripes and profiles
- 805 outdoor | mounting accessories
- 806 indoor / outdoor | chemical products



□ indoor dimming from page 782



□ indoor dimming and switching from page 784



□ indoor other from page 785



□ indoor low voltage from page 787



□ indoor low voltage plug-in connector from page 788



□ outdoor low voltage DC WEIPU HQ plug-in connector from page 791



□ indoor / outdoor DMX cable from page 794



□ indoor high voltage cable connectors from page 796



□ indoor high voltage plug systems from page 798



□ outdoor high voltage plug systems from page 799



□ outdoor cable connectors from page 801

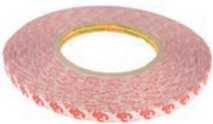

□ indoor / outdoor mounting material for LED stripes and profiles from page 804



□ outdoor mounting accessories from page 805



□ indoor / outdoor chemical products from page 806



accessories



DIMMER | PHASE CONTROL

suitable for dimming of:

- R loads [light sources] 20 - 500 W
- L loads [konventionell wound transformers] 20 - 500 W
- max. 5 electronical ballast
- suitable for 68 mm flush-mounted / cavity wall sockets

item	colour	price
100484	<input type="checkbox"/> white	79,95 €



DIMMER | PHASE CUT-OFF

suitable for dimming of:

- R loads [light sources] 10 - 350 W
- C loads [electrical electronical ballasts] 10 - 350 W
- max. 5 electronical ballast
- adjustable minimum load / brightness
- perfectly matched to DEKO-LIGHT power supplies
- suitable for 68 mm flush-mounted / cavity wall sockets

item	colour	price
930060	<input type="checkbox"/> white	66,95 €

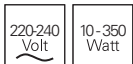

DIMMING VIA PHASE CONTROL/CUT-OFF

Please always ensure that the dimmer used is suitable for new installations and especially when retrofitting existing systems. You will find information on the housing as well as in the technical data sheets for which type of load, power and quantity of ballasts they are suitable.

types of electrical loads:

- [R] = Ohmic load = light bulb, high-voltage halogen etc.
- [L] = Inductive load* = wound transformers
- [C] = Capacitive load* = high voltage LED, all electrical transformers

*Unless otherwise stated, max. 5 [C-load] or 2 [L-load] ballasts/lamps per dimmer.

You would like to dim and switch 230V components from several locations, but do not have the required number of cores in the existing installation? Then the following

universal dimmer switches are ideally suited for simple and problem-free integration for both existing and new installations.

ELTAKO DIMMER UNIVERSAL 400W EUD12NPN-UC

- control via standard pushbutton
[control voltage 10V-230V AC+DC]
- short keys [on / off], long keys [dimming 0-100-0%]
- suitable for R-L-C loads up to 400W, high voltage LEDs up to 100W, automatic load detection, memory-function, adjustable minimum load and dimming speed
- dimensions L x W x H: 20 x 90 x 70 mm

item	colour	price
843042	 blue	109,95 €



ELTAKO DIMMER UNIVERSAL 400W EUD61NPN-UC

- control via standard pushbutton
[control voltage 10V-230V AC+DC]
- short keys [on / off], long keys [dimming 0-100-0%]
- suitable for R-L-C loads up to 400W, high voltage LEDs up to 100W, automatic load detection, memory-function, adjustable minimum load and dimming speed
- installation in junction box possible
- dimensions L x W x H: 45 x 45 x 18 mm

item	colour	price
843043	 blue	104,95 €



ELTAKO LED-DIMMER SWITCH ELD61/12-36V

- control via standard pushbutton
[control voltage 10V-230V AC+DC]
- short keys [on / off], long keys [dimming 0-100-0%]
- suitable for 12V/24V/36V LED stripes and dimmable LED lamps
- power 48W at 12V, 96W at 24V
- soft-off for lamp protection
- memory-function, adjustable minimum brightness dimming speed
- dimensions L x W x H: 45 x 45 x 18 mm

item	colour	price
843033	 blue	99,95 €



ELTAKO STEUERDIMMSCHALTER SDS61/1-10V

- control via standard pushbutton [control voltage 230V], that generates a 1-10V control signal [max. 40 mA] at the output
- short keys [on / off], long keys [dimming 0-100-0%]
- suitable for dimmable power supply mit 1-10V control input
- switching output [ECG on / off] memory-function and adjustable dimming speed
- dimensions L x W x H: 45 x 45 x 33 mm



item	colour	price
843044	■ blue	99,95 €

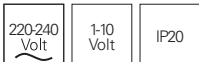

HIGH FREQUENCY MOTION SENSOR | MD1200

- angle of coverage 360°
- detection range 1 - 10 m
- switching time 5 sec - 30 min
- daylight threshold 5 - 2000 Lux
- suitable for switching all common illuminants / electronical ballast [R- / L / C-loads]
- max. 5 electronical ballast
- dimensions L x W x H: 75 x 42 x 28 mm



item	colour	price
930036	□ white	44,95 €



MAGIC SWITCH

The MAGIC SWITCH is the invisible switch for a variety of applications. Mounted on a plate back or incorporated into a blind hole, it detects the movement taking place on the front of the plate and switches. The MAGIC SWITCH works only in connection with non-metallic surfaces and materials such as wood, glass, ceramics up to a material thickness of 19 mm.



item	colour	price
920132	■ black	74,95 €



ELTAKO RC ELEMENT THREE-WAY RC12-230V

By inductive interference voltages on control and power lines, there is an increasing number of undesirable effects that linear LED lights, which have a very low power consumption, permanently glow or flash due to the design. By installing the RC extinguishing element in the electrical distributor [connection N, L1, L2, L3] inductive interference voltages are compensated / suppressed.

- dimensions L x W x H: 20 x 90 x 70 mm

item	colour	price
843045	 blue	64,95 €



OVERVOLTAGE PROTECTION WITH CONTROL DISPLAY

Compact overvoltage protection that effectively prevents the premature failure of LED lights due to problems in power grids. For protection of 1-phase operated, non-dimmable LED lighting systems. Control LED to indicate correct operation. Depending on the connection there is the possibility of load circuit disconnection in case of a fault. IP67 design for direct installation in luminaires or upstream in junction boxes.

- plastic
- dimensions L x W x H: 37 x 30 x 20 mm

item	colour	price
843055	 black	21,95 €

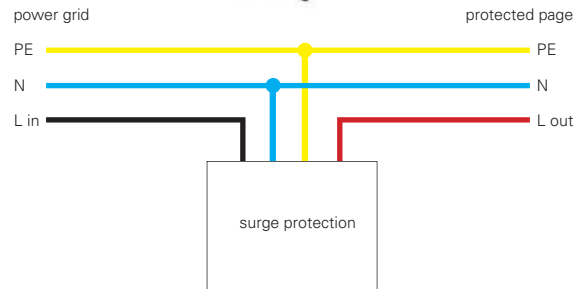
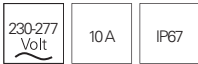

SAFETY SPACER

- for ceiling mounting rings from Ø 62 to 90 mm
- height 80 mm

item	colour	price
829063	 black	6,95 €

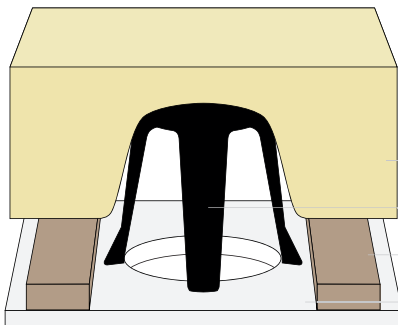



GU5,3 SOCKET

- ceramics
- thermo resistant connection cable

item	colour	connection cable	price
100200	<input type="checkbox"/> white	15 cm	1,25 €
100250	<input type="checkbox"/> white	50 cm	2,25 €



LOW VOLT SCREW DISTRIBUTOR SIX-WAY

- for fast cabling of up to 6 voltage-stable [CV] components on one power supply
- dimensions L x W: 63,5 x 26,0 mm
- 25 cm connection cable

item	colour	price
930006	<input type="checkbox"/> white	9,95 €



CONNECTION DISTRIBUTOR FOR CURRENT-STABLE [CC] LUMINAIRES

- for fast cabling of up to 2 constant-stable [CC] components on one power supply for series connecting
- 3x 2 connectings 0,34 - 0,5 mm²
- dimensions H x Ø: 11 x 35 mm

item	colour	price
930001	<input type="checkbox"/> white	3,95 €



AMP-PLUG-IN DISTRIBUTOR SIX-WAY

- 2-pole version
- with quick connector / lock
- cable H03 VVH2-F 2x 0,75 mm²
- 10 cm connection cable

item	colour	price
053001	<input type="checkbox"/> white	5,95 €



AMP-EXTENSION LINE

- 2-pole version
- with quick connector / lock
- cable H03 VVH2-F 2x 0,75 mm²

item	colour	dimensions L	price
050100	<input type="checkbox"/> white	100 cm	4,95 €
050200	<input type="checkbox"/> white	200 cm	5,95 €



AMP-PLUG WITH GU5,3 SOCKET

- 2-pole version
- with quick connector / lock
- 13 cm connection cable

item	colour	price
050222	<input type="checkbox"/> white	4,95 €



MINI-AMP CONNECTION CABLE | EXTENSION CABLE

- 2-pole version
- ready-to-plug-in installation of pre-assembled component
- simple and reverse polarity protected installation

item	colour	version	dimensions L	price
940032	<input type="checkbox"/> white	connection cable - plug	30 cm	2,95 €
940036	<input type="checkbox"/> white	connection cable - plug	100 cm	3,95 €
940040	<input type="checkbox"/> white	connection cable - plug	200 cm	4,95 €
940044	<input type="checkbox"/> white	extension - plug/socket	50 cm	5,95 €
940048	<input type="checkbox"/> white	extension - plug/socket	100 cm	6,95 €
940052	<input type="checkbox"/> white	extension - plug/socket	200 cm	7,95 €

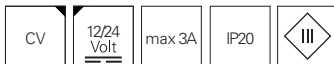

MINI-AMP MULTIPLE DISTRIBUTOR | PLUG - SOCKET

- 2-pole version
- ready-to-plug-in installation of pre-assembled component
- simple and reverse polarity protected installation

item	colour	version	connectings	price
940064	<input type="checkbox"/> white	three-way / 20 cm	1x plug, 3x socket	6,95 €
940065	<input type="checkbox"/> white	six-way / 20 cm	1x plug, 6x socket	7,95 €

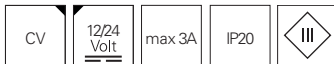

MINI-AMP INSERT SWITCH | PLUG - SOCKET

- 2-pole version
- ready-to-plug-in installation of pre-assembled component
- simple and reverse polarity protected installation

item	colour	dimensions L	price
940066	<input type="checkbox"/> white	2x 100 cm	12,95 €

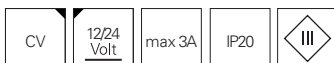

MINI-AMP ADAPTER MR16/GU5,3 | SOCKET - PLUG

- 2-pole version
- ready-to-plug-in installation of pre-assembled component
- easy mounting

item	colour	dimensions L	price
940067	<input type="checkbox"/> white	50 cm	4,95 €

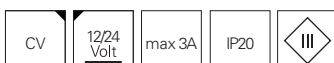





WEIPU HQ SOCKET / PLUG | 2-POLE

item	colour	version	price
940059	■ black	socket with screw cap	13,95 €
940060	■ black	plug	13,95 €
940058	■ black	socket special design	13,95 €



WEIPU HQ SOCKET / PLUG | 4-POLE

item	colour	version	price
940063	■ black	socket with screw cap	14,95 €
940062	■ black	plug	14,95 €
940061	■ black	socket special design	14,95 €



WEIPU HQ SOCKET / PLUG | 5-POLE

item	colour	version	price
940056	■ black	socket with screw cap	15,95 €
940057	■ black	plug	15,95 €



WEIPU CABLE

When planning and installing low-voltage DC systems, always pay attention to the cable lengths. A total length of 10 metres must not be exceeded. Excessive lengths can lead to voltage losses within the cables, e.g. to different colour renditions of RGB spotlights or visible brightness differences. Malfunctions such as flashing, flickering or flashing of the lamps can also occur. Furthermore, each radiator should be supplied with a separate connection cable if possible. Avoid installations with more than 3 radiators within one cable harness.

WEIPU HQ

Our new Weipu HQ cable series provides the highest quality cables and connectors, as well as higher cable crosssections for even more reliability and durability for the power supply and operation of the corresponding spotlights.

WEIPU HQ SUPPLY CABLE | SOCKET 2-POLE

item	colour	dimensions L	price
940037	■ black	1 m	22,95 €
940038	■ black	3 m	29,95 €
940039	■ black	5 m	37,95 €



WEIPU HQ SUPPLY CABLE | SOCKET 4-POLE

item	colour	dimensions L	price
940033	■ black	1 m	27,95 €
940034	■ black	3 m	42,95 €
940035	■ black	5 m	55,95 €



WEIPU HQ SUPPLY CABLE | SOCKET | 5-POLE

item	colour	dimensions L	price
940029	■ black	1 m	31,95 €
940030	■ black	3 m	47,95 €
940031	■ black	5 m	59,95 €



WEIPU HQ CONNECTION CABLE | 2-POLE

item	colour	dimensions L	price
940049	■ black	1 m	34,95 €
940050	■ black	3 m	42,95 €
940051	■ black	5 m	49,95 €



WEIPU HQ CONNECTION CABLE | 4-POLE

item	colour	dimensions L	price
940045	■ black	1 m	42,95 €
940046	■ black	3 m	56,95 €
940047	■ black	5 m	68,95 €



WEIPU HQ CONNECTION CABLE | 5-POLE

item	colour	dimensions L	price
940041	■ black	1 m	47,95 €
940042	■ black	3 m	60,95 €
940043	■ black	5 m	72,95 €



WEIPU JUNCTION BOX

- 2 outgoing plug sockets
- dimensions L x W x H: 57 x 57 x 38 mm

item	colour	Pole	connection cable	price
730300	■ black	2	30 cm	64,95 €
730301	■ black	4	30 cm	68,95 €
940010	■ black	5	100 cm	78,95 €



DMX-CONNECTION CABLE

- XLR-cable
- 3-pole plug / socket

item	colour	dimensions L	price
819066	■ black	1 m	19,95 €
819067	■ black	2 m	22,95 €
819070	■ black	5 m	24,95 €
819072	■ black	10 m	29,95 €
819071	■ black	20 m	39,95 €



DMX-CONNECTION CABLE OUTDOOR

- XLR-cable
- 3-pole plug / socket

item	colour	dimensions L	price
180704	■ black	2 m	16,95 €
180705	■ black	5 m	26,95 €
180706	■ black	10 m	46,95 €



DMX-CABLE ADAPTER | CAT5 AUF DMX XLR

item	colour	version	price
882271		DMX-plug to CAT5	54,95 €
882272		DMX-socket to CAT5	54,95 €



illustr. shows DMX-plug

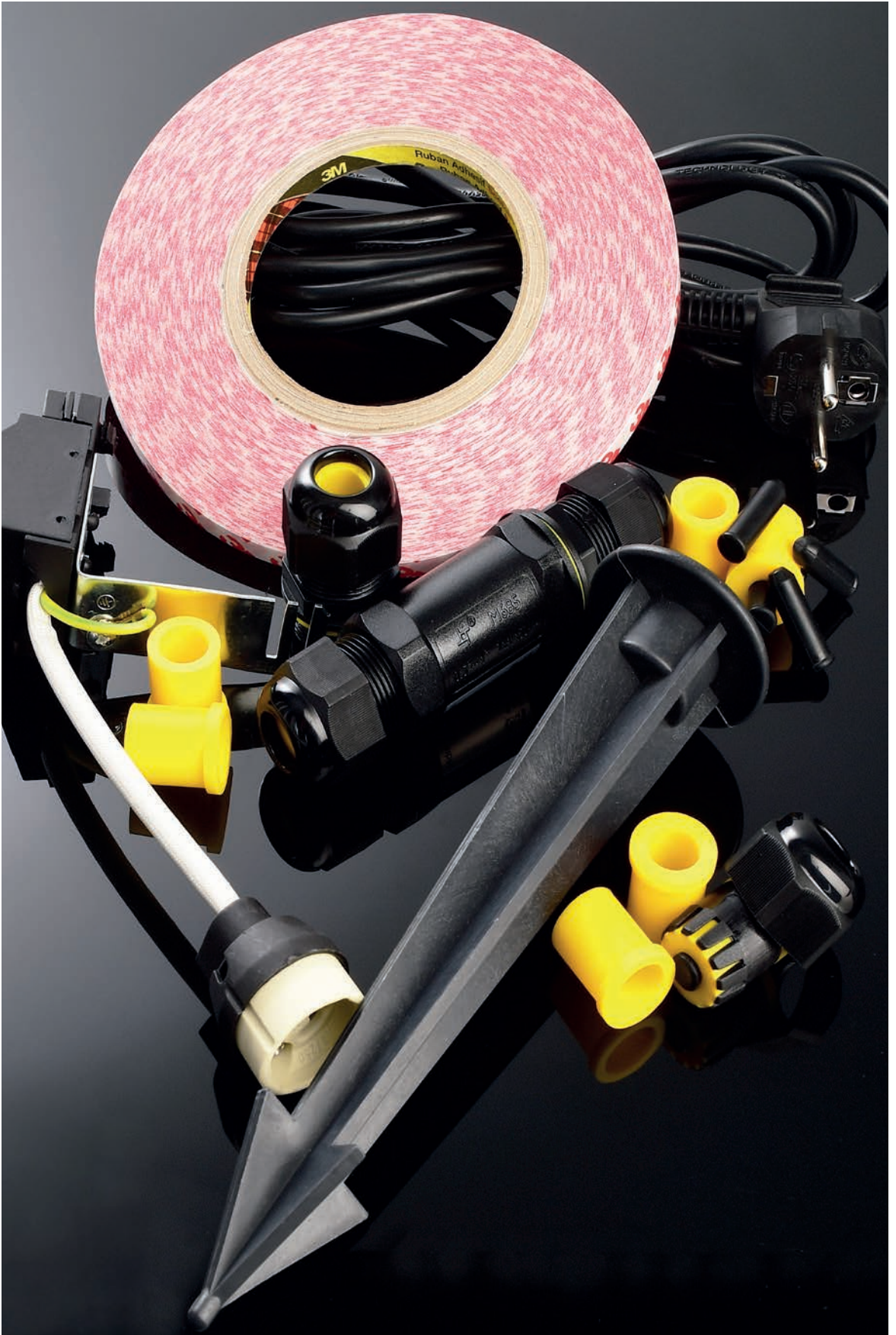

CERAMIC CLAMPS

- 2-pole, with fixing hole
- cable bis max. 2,5mm²
- dimensions L x W x H: 21 x 18 x 10 mm

item	colour	price
100301	<input type="checkbox"/> white	1,15 €

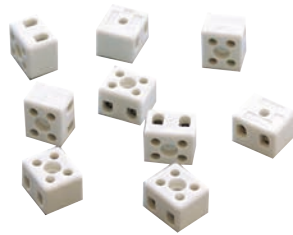

GU10 SOCKET

- ceramics
- 15 cm connection cable

item	colour	price
100202	<input type="checkbox"/> white	3,45 €



GU10 SOCKET

- spacer combined with junction box
- separate connection for protective conductor
- 10 cm cable

Essential: screw fitting mandatory for using with assembling frame between spacer VDE.

item	colour	price
100204	<input type="checkbox"/> white	4,45 €



CONNECTION CABLE WITH 230V MAINS PLUG

- plastic
- universally usable
- cable H07RN-F, 3x 1,5mm²
- open cable ends



item	colour	dimensions L	price
930587	■ black	2950 mm	21,95 €

220-240 Volt	max. 16 A	IP44
-----------------	--------------	------



quick terminal



through-wiring

DEKOLIGHT QUICK CONNECT BOX 2-WAY 230V

- plastic
- universally applicable for quick connection or wiring of power supply units or luminaires
- 3-pole plug-in terminals for rigid or flexible cables [e.g. NYM] from 0.5 to 1.5mm²
- 15cm pre-installed 3-core cable for connection to SKI/SKII power supplies/luminaires
- open cable ends
- quick release fastener secured with additional screw
- for insertion into ceilings with min. 68mm round cut-out and starting from a ceiling gap of 25mm

item	colour	dimensions L x W x H	price
930694	■ black	80 x 40 x 25 mm	7,95 € NEW

220-240 Volt	max. 16 A	IP20
-----------------	--------------	------

WIELAND GST18i3 PLUG | SOCKET | DISTRIBUTOR BLOCK

• high voltage, 3-pole, for wire cross section 0,75 - 2,5 mm²

item	colour	version	price
800105	■ black	plug	7,95 €
800100	■ black	socket	7,95 €
800115	■ black	distributor block, 1 input, 5 outputs	26,95 €



WIELAND GST18i3 SUPPLY CABLE WITH SCHUKO PLUG

• high voltage, 3-pole, for wire cross section 3 x 1,5 mm²

item	colour	dimensions L	price
800116	■ black	200 cm	19,95 €



WIELAND GST18i3 SUPPLY CABLE WITH SOCKET | PLUG

• high voltage, 3-pole, for wire cross section 3 x 1,5 mm²

item	colour	version	dimensions L	price
800109	■ black	socket	100 cm	10,95 €
800111	■ black	socket	300 cm	16,95 €
800112	■ black	plug	100 cm	11,95 €
800114	■ black	plug	300 cm	16,95 €



WIELAND GST18i3 EXTENSION LINE

• high voltage, 3-pole, for wire cross section 3 x 1,5 mm²

item	colour	dimensions L	price
800106	■ black	100 cm	16,95 €
800107	■ black	200 cm	18,95 €
800108	■ black	300 cm	22,95 €



WIELAND RST20i3 PLUG | SOCKET DISTRIBUTOR BLOCK | PROTECTIVE CAP

• high voltage, 3-pole, for wire cross section 1,5 mm² - 4,0 mm²

item	colour	version	price
800024	■ black	plug	15,95 €
800023	■ black	socket	15,95 €
800025	■ black	distributor block, 1 input, 3 outputs	25,95 €
800026	■ black	protective cap for plug	3,95 €
800027	■ black	protective cap for socket	3,95 €



220-240 Volt	max. 16 A	IP68
-----------------	--------------	------

WIELAND RST20i3 SUPPLY CABLE WITH SCHUKO PLUG

• high voltage, 3-pole, for wire cross section 3 x 1,5 mm²
• mains plug IP44 / socket IP68

item	colour	dimensions L	price
800028	■ black	400 cm	69,95 €

220-240 Volt	max. 16 A	IP68
-----------------	--------------	------



WIELAND RST20i3 SUPPLY CABLE

• high voltage, 3-pole
• with socket and open end
• cable type H07RN-F3
• G1/5 1,5 mm²

item	colour	dimensions L	price
800033	■ black	200 cm	29,95 €

220 Volt	max. 16 A	IP68
-------------	--------------	------



WIELAND RST20i3 CONNECTION CABLE SOCKET | PLUG

• high voltage, 3-pole
• cable type H07RN-F3
• G1/5 1,5 mm²

item	colour	dimensions L	price
800029	■ black	200 cm	34,95 €
800036	■ black	400 cm	48,95 €

220 Volt	max. 16 A	IP68
-------------	--------------	------



MULTI OUTDOOR CABLE DISTRIBUTORS

The more luminaires and accompanying lighting solutions are planned and project, the more complex the cable management becomes. A wide variety of cable and wire cross-sections come together and have to be connected as efficiently as possible. In outdoor areas, there are requirements added to protect cables against external influences. With the new, multifunctional cable connectors and distributors, you are perfectly equipped for these tasks.

All multi-outdoor cable distributors are supplied with the appropriate adapter sleeves in order to be able to insert different cable cross-sections, depending on the model.

waterproof cable glands

supplied blind plugs for unused cable entries
cable entries

access to cables via screwed, waterproof cover



OUTDOOR CABLE CONNECTORS GELBOX IPX8

- set consisting of 2 gel boxes
- silicone
- dimensions L x W x H: 38 x 30 x 26 mm
- suitable for 3 x 2,5mm² / 5 x 2,5mm²



item	colour	price
930402	 colourless	28,95 €



MULTI OUTDOOR CABLE CONNECTORS | CONNECTION SLEEVE

- waterproof cable glands M25
- for 2 cable 4-14 mm [adapter grommets included]
- for 2-5 cores 0,5-4 mm²
- L x W x H: 112,53 x 29,50 x 32,56 mm
- observe installation instructions



item	colour	price
930571	 black/yellow	17,95 €

 12-230 Volt	max. 24 A	IP68 [2 m]
---	-----------	------------

MULTI OUTDOOR Y-CABLE CONNECTORS | CONNECTION SLEEVE

- waterproof cable glands M25
- for 3 cable 4-14 mm [adapter grommets included]
- for 2-3 cores 0,5-4 mm²
- L x W x H: 139,71 x 71,88 x 32,56 mm
- observe installation instructions



item	colour	price
930573	 black/yellow	19,95 €

 12-230 Volt	max. 24 A	IP68 [2 m]
---	-----------	------------

MULTI OUTDOOR CABLE DISTRIBUTOR 2-FOLD

- waterproof cable glands M20
- for 2 cable 5-12 mm [adapter grommets included]
- for cores 0,5-2,5 mm²
- Ø x H: 65,33 x 46,31 mm
- cover: quick screw connection [screwless]
- observe installation instructions



item	colour	price
930578	■ black	9,95 €



MULTI OUTDOOR CABLE DISTRIBUTOR 2-FOLD

- waterproof cable glands M20
- for 2 cable 5-12 mm [adapter grommets included]
- for cores 0,5-2,5 mm²
- L x W x H: 138,20 x 42,77 x 35,70 mm
- cover verschraubt [screws included in delivery]
- observe installation instructions



item	colour	price
930576	■ black/yellow	12,95 €

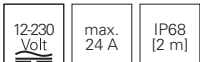

MULTI OUTDOOR CABLE DISTRIBUTOR 4-FOLD

- waterproof cable glands M25
- for 2-4 cable 4-14 mm [adapter grommets included]
- for cores 0,5-4,0 mm²
- L x W x H: 112,54 x 93,30 x 35,30 mm
- cover verschraubt [screws included in delivery]
- observe installation instructions



item	colour	price
930575	■ black/yellow	19,95 €

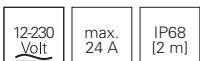

MULTI OUTDOOR STRAIGHT JOINT CAPSULE 4-FOLD

- spacious socket
- for 2-4 cable 6-14 mm
- for cores bis 2,5 mm²
- Ø x L: 70 x 190 mm
- FDM1: humic acid and corrosion resistant
- quick screw connection [screwless]
- incl. 8 cable ties 150,00 x 2,20 mm
- observe installation instructions



item	colour	price
730275	 black/yellow	48,95 €

 12-230 Volt	max. 24 A	IP68 [1 m]
---	-----------	------------



MULTI OUTDOOR CABLE DISTRIBUTOR 10-FOLD

- waterproof cable glands M25
- for 2-10 cable 4-14 mm [adapter grommets included]
- for cores 0,5-4,0 mm²
- L x W x H: 182,95 x 135,30 x 49,10 mm
- cover verschraubt [screws included in delivery]
- observe installation instructions

item	colour	price
930574	 black/yellow	42,95 €

 12-230 Volt	max. 24 A	IP68 [2 m]
---	-----------	------------

ASSEMBLY SET FOR IP65/IP67 LED-STRIPES

- set consists of:
15 silicone retaining clips
30 stainless steel screws
5 end caps
- delivery without silicone/adhesive



item	colour	for stripes with outer dimension	price
840293	<input checked="" type="checkbox"/> colourless	11-12 mm	4,95 €
840294	<input checked="" type="checkbox"/> colourless	13-15 mm	4,95 €
840295	<input checked="" type="checkbox"/> colourless	17-19 mm	4,95 €
end cap seal			
930104	natural stone sealant		39,95 €

3M™ DOUBLE-SIDED TAPE

- for mounting aluminium profiles or LED strips [not IP65/67 silicone strips] on smooth surfaces

item	colour	dimensions L x W x H	price
930345	<input type="checkbox"/> white	50000 x 08 x 0,20 mm	19,95 €
930346	<input type="checkbox"/> white	50000 x 10 x 0,20 mm	21,95 €
930347	<input type="checkbox"/> white	50000 x 12 x 0,20 mm	23,95 €
930348	<input type="checkbox"/> white	50000 x 15 x 0,20 mm	26,95 €
930349	<input type="checkbox"/> white	50000 x 20 x 0,20 mm	34,95 €
930350	<input type="checkbox"/> white	50000 x 25 x 0,20 mm	42,95 €

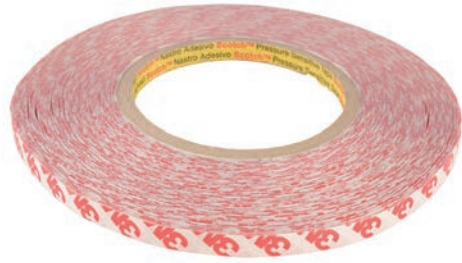

3M™ DOUBLE-SIDED TAPE FOR SILICONE SURFACES

- special adhesive tape for use on LED stripes in silicone hoses and silicone casting
- high solvent resistance
- high temperature resistance
- high initial liability
- high bond strength on most silicone surfaces and hard-to-stick substrate



item	colour	dimensions L x W x H	price
930405	<input type="checkbox"/> white	55000 x 10 x 0,127 mm	174,95 €
930406	<input type="checkbox"/> white	55000 x 12 x 0,127 mm	204,95 €



PRESSURE / MOISTURE COMPENSATING VALVE WITH MEMBRAN

- plastic
- set of 5
- minimisation of condensation due to integrated liquid-tight and breathable membrane
- for retrofitting luminaires that are used in warm and humid areas / environments
- pressure rang: P=7Kpa
- incl. plastic flat nut

item	colour	Ø	max. air exchange	price
930583	■ black	M5	380 ml/min.	14,95 €
930584	■ black	M8	800 ml/min.	15,95 €
930585	□ white	M10	1200 ml/min.	16,95 €
930586	□ white	M16	2200 ml/min.	18,95 €

IP67

GROUND SPIKE IN CONNECTION WITH INSERT NUT

- plastic / metal
- for ground anchoring of surface-mounted luminaires in the ground

item	colour	Ø	dimensions L x Ø	price
700230	■ black	M5	200 x 50 mm	5,95 €
930426	■ black	M5	170 x 40 mm	9,95 €
700229	■ black	M6	160 x 43 mm	5,95 €
730349	■ black	M6	210 x 45 mm	7,95 €
930427	■ black	M10	219 x 45 mm	12,95 €



design example

WALL BRACKET / DISPLAYARM

- metal
- dimensions L: 80 cm
- carrying capacity max. 4,5 kg
- for mounting surface-mounted luminaires at a distance to the object / advertising sign
- optimal for the illumination of advertising signs on facades
- due to different applications delivery without mounting material



item	colour	price
930659	■ black	72,95 € NEW

ISOLATING SPRAY

- spray can, 400 ml
- spray forms a flexible, UV-resistant protective coating for LED strips, connecting leads, electronic components and electrical connections

item	colour	price
930663	<input checked="" type="checkbox"/> colourless	45,95 € NEW



GEL ADHESIVE FOR GLUING END CAPS

- cyanoacrylate instant adhesive
- tube 3g
- high initial adhesion
- very good adhesion to almost all substrates such as metals, steel, stainless steel, galvanised steel, aluminium, plastics [e.g. ABS, GRP, hard PC] or ceramic materials
- curing time: 8-12 Stunden
- observe safety and processing instructions

item	colour	price
930593	<input checked="" type="checkbox"/> colourless	5,95 €



MOUNTING GLUE

- bond+seal power
- cartridge, 310 ml
- highly resilient, elastic 1-component construction adhesive
- very good adhesion on almost all surfaces like e.g. metals, steel, stainless steel, galvanised steel, aluminium, plastics [e.g. ABS, GFK, rigid PVC] or ceramic materials
- UV-resistant
- approved according to NSF food law [NSF, P1 registered: 136996]
- high initial strength
- overpaintable with all commercial paint systems [except alkyd resin varnishes]

item	colour	price
930105	<input type="checkbox"/> white	35,95 €



NATURAL STONE SEALANT

- cartridge, 310 ml
- suitable for gluing profile covers and for use in wet rooms
- does not attack the surface of LEDs/strips
- permanently elastic
- high resistance to weathering, UV, ageing and colour
- excellently suited for heavy outdoor use

item	colour	price
930104	<input checked="" type="checkbox"/> colourless	39,95 €



SEALANT SMOOTHING AGENT

- spray can, 400 ml
- universally suitable for clean stripping for all types of sealants [e.g. silicones, polyurethane sealants etc.]
- easy processing from the aerosol can
- through uniform cross-linking of the surface the sealant joint hardens faster and the surface is improved

item	colour	price
930103	<input checked="" type="checkbox"/> colourless	39,95 €





LIGHT COLOUR SELECTABLE

Luminaires with the designation "CCT Dip" allow you to change the light colour via a small dip switch [usually in the steps 3000K / 4000K / 5000K]. With their high application flexibility, CCT Dip luminaires offer customers who are still unsure about the light colour an enormous decision-making aid - and incidentally reduce your stock requirements.



The colour temperature [light colour] is specified in Kelvin [K] and determines how the respective light is perceived.

WW = warm white light	2.300 K to 3.300 K [high red component]
NW = neutral white light	3.300 K to 5.300 K
CW = cool white / daylight white light	5.300 K to 8.000 K [high blue content]

The following guide values apply as orientation for different rooms following guide values apply:

living and sleeping are	WW
kitchen and bathroom	WW NW
offices	NW
industry	NW CW
photo studio / architectural lighting	CW



COLOUR RENDERING INDEX RA

The colour rendering index Ra is the measure of the correspondence of the perceived light colour between an existing lighting situation and a reference light source. The smaller the deviation, the better the colour rendition. A light source with Ra 100 reproduces all colours exactly. The lower the Ra value, the less precisely the colours are reproduced.

Standard values:	
Incandescent bulb, halogen lamps	up to Ra 100
LED lamps	Ra 75-95
Compact fluorescent and energy-saving lamps	Ra 80-89
Fluorescent lamps	Ra 70-85



RA 70-80 medium colour rendition



RA 80-90 good colour rendition



RA 90-100 very good colour rendition



HCL

HCL stands for "Human Centric Lighting" and means the simulation of lighting situations according to the biological day-night rhythm of humans. HCL matches artificial light indoors to natural daylight and promotes well-being, mood and health. Numerous DEKO-LIGHT luminaires can already be integrated into an HCL control system to adjust the light colours to the biorhythm. In addition, several LED stripes in different light colours can be combined in one profile and thus integrated into the HCL lighting design.

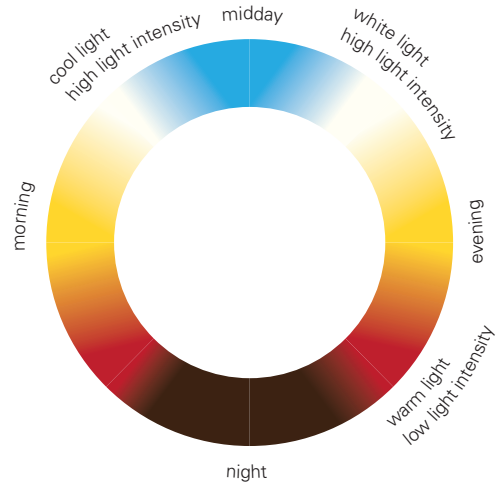

UGR VALUE

The smaller the UGR value, the more glare-free a luminaire emits its light. Especially in office areas, luminaires with a UGR value of less than 19 should be used to avoid disturbing reflections. When determining the UGR value of a complete room, additional factors such as wall colour[s] and surface finishes play a role.



DIM TO WARM

With the dim-to-warm function, you not only adjust the luminous intensity downwards, but by simultaneously changing the light colour [e.g. from 3000 to 2000 K], you obtain a room mood adapted to the new situation. LED luminaires with dim-to-warm technology can therefore be used particularly flexibly.



DALI DIMMABLE

Luminaires that can be dimmed via DALI can be perfectly integrated into lighting/property management systems. The great advantage lies in the wiring: via DALI, all luminaires in a line can be individually addressed and controlled. But this variant is also suitable for individual luminaires: DALI dimmers without an address exist for this purpose, which address the power supply unit directly. The good news: most systems on the market already have DALI interfaces.



HIGH LUMEN PACKAGE

Luminaires with high lumen values are ideal for illuminating rooms or corridors. With the right wall luminaires, you can achieve the prescribed lux values for corridors [100 lux] in many cases without additional ceiling lighting.

WHAT IS HOW BRIGHT?

How many lumens do different lamps shine with?

candle	~ 12 lm
100W incandescent bulb	~ 1.340 lm
40W fluorescent lamp	~ 3.000 lm

WHERE DO I NEED HOW MANY LUMENS?

You should plan for these lumens per square metre, so that your home is optimally and comfortably illuminated:

guide values:	
living room	approx 140 lm/m ²
bedroom	approx 140 lm/m ²
children's room	approx 140 lm/m ²
hallway	approx 140 lm/m ²
study	approx 280 lm/m ²
kitchen	approx 280 lm/m ²
bathroom	approx 280 lm/m ²

HOW MANY LUMENS CORRESPOND HOW MANY WATT?

Luminous efficacy is measured in lumens per watt [lm/W] and indicates how efficiently a lamp shines and how energy is converted into light.

guide values:	
incandescent bulb	approx 10 lm/W
halogen lamp	approx 20 lm/W
fluorescent lamp	approx 70-90 lm/W
LED lamp	approx 60-170 lm/W

WHAT DOES »LUX« MEAN?

Lux [lx] is the physical unit of the illuminance of a light source. This photometric quantity indicates how much luminous flux from a light source falls on a given surface.

Of course, the following values do not have to be achieved in the entire room.

guide values:	
bedroom	45 Lux
living room	77 Lux
bathroom	110 Lux
hallway	207 Lux
study/office	300 Lux [at desk: 500 Lux]



IK VALUE

In addition to the IP protection class, you should also keep an eye on the IK value of a luminaire, which is increasingly required within the scope of tenders and for installations in public spaces. The IK value [or IK impact resistance level] indicates how impact-resistant a luminaire or certain components are. IK00 offers no protection against external mechanical stress, IK10 or IK10+ means that the luminaire can withstand a 5 or 10 kg test weight from a distance of 40 or 50 cm.

There are eleven codes, corresponding to the impact energy that an enclosure can withstand. [source: wikipedia.org]

Code	impact energy in joules	corresponds to drop height in mass	
IK00	no protection		
IK01	0,14	7 cm	- 200 g
IK02	0,20	8 cm	- 250 g
IK03	0,35	14 cm	- 250 g
IK04	0,50	20 cm	- 250 g
IK05	0,70	28 cm	- 250 g
IK06	1,0	40 cm	- 250 g
IK07	2,0	40 cm	- 500 g
IK08	5,0	25 cm	- 2000 g
IK09	10,0	20 cm	- 5000 g
IK10	20,0	40 cm	- 5000 g
IK10+	50,0	50 cm	- 10000 g



CHANGEABLE LED CHIPS

We want to leave our children a world worth living in. With the advent of LED technology, many luminaires could no longer be repaired and became disposable products. Thanks to a high recycling rate, a large part of the raw materials can already be returned to the system - nevertheless, we want to do even better: Ideally, the LED or the POWER SUPPLY of every DEKO-LIGHT luminaire can be replaced in the event of a malfunction. With the new Green Label »LED chip replaceable«, the DEKO-LIGHT brand is sending an unmistakable signal: Luminaires with this label enable environmentally friendly replacement of LED chips. In combination with low power consumption and a long service life, DEKO-LIGHT luminaires are already helping to reduce the burden on the environment. Support us in this and look out for the Green Label at DEKO-LIGHT.



WHAT IS THE »AVERAGE RATED LIFE« OF AN LED?

The average rated service life of LEDs covers the period from the first time they are switched on until the time when only 50 percent of the LEDs tested are still functioning properly.

A specified service life of 30,000 hours for an LED stripe therefore means that after this period, on average, half of all stripes will have failed.

WHAT DOES »BINNING« MEAN?

Binning guarantees a constant quality of light with the same brightness level and uniform light colour. For this purpose the LEDs of a production batch are sorted and divided into so-called »bins«.

NORM TABLE

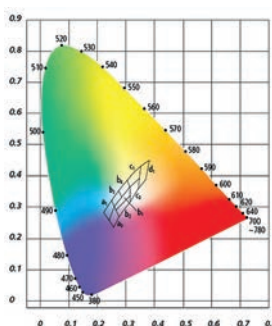

BINNINGS

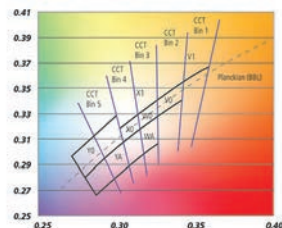

WHITE LEDS

With the kind support of Licht von Klein / www.licht-von-klein.de



IP PROTECTION ZONES

ZONE 3 | IP23

Outside zones 0 to 2, no special IP protection is necessary, provided no cleaning with direct water irradiation takes place.

ZONE 2 | IP44

In the areas 60 cm from zone 1, IP X4 protection applies.

ZONE 1 | IP65

In the wall area of the shower as well as in the tile area exposed to IP X5 is specified for the wall area of the shower and in the tile area exposed to splash water [max. 50 V].

ZONE 0 | IP67

In bathtubs and shower trays, low-voltage [max. 12 V] is absolutely required. The minimum IP protection is IP X7 [protected against water penetration].

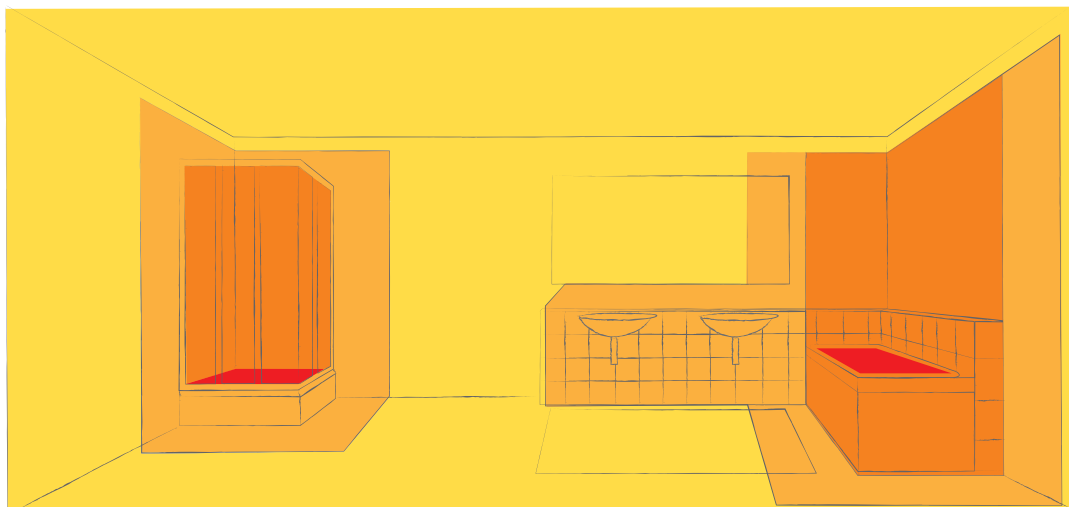
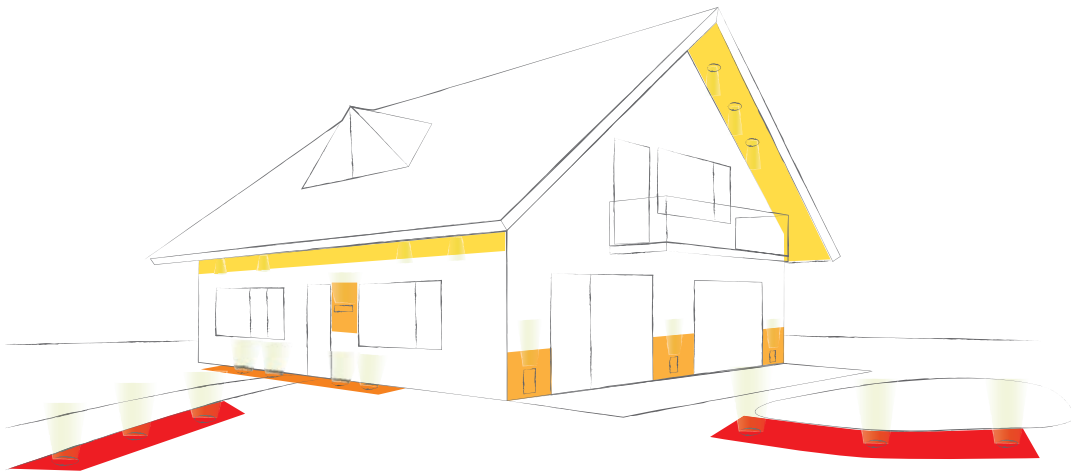

PROTECTION TYPES AND INSULATION CLASSES

Luminaires and other electrical appliances have a housing that protects live parts from contact, moisture or other environmental influences. This protection depends on the respective area of application. In order to have an overview of the suitable application, all devices are assigned to a classified protection type and an insulation class.

IP67

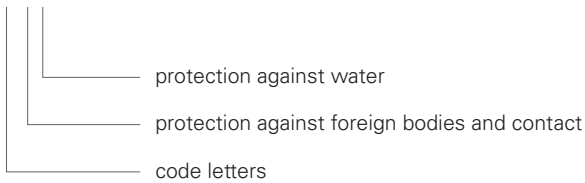

1. digit	protection against foreign bodies and contact	2. digit	protection against water
0	no protection	0	no protection
1	large foreign bodies [Ø > 50 mm] large body parts [e.g. back of the hand]	1	protection against vertically falling dripping water
2	medium-sized foreign bodies [Ø > 12 mm] finger	2	protection against dripping water falling at an angle [up to 15°]
3	small foreign bodies [Ø > 2,5 mm] tools and wires [Ø > 2,5 mm]	3	protection against water spray up to 60° from vertical
4	granular foreign bodies [Ø > 1 mm] tools and wires [Ø > 1 mm]	4	protection against splashing water on all sides
5	dust deposit complete protection against accidental contact	5	protection against jet water
6	dust entry complete protection against accidental contact	6	protection against jet water
		7	protection against temporary immersion
		8	protection against permanent immersion

ELECTRIC CHARACTERISTICS

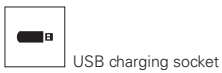
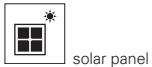
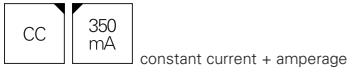
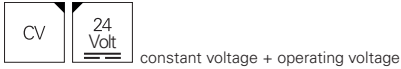
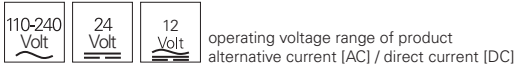

LAMP

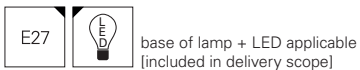
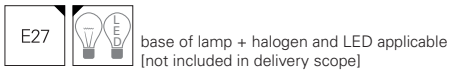
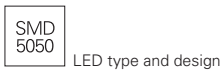
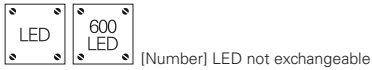
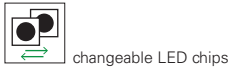
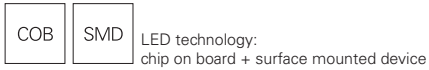

FUNCTIONALITY

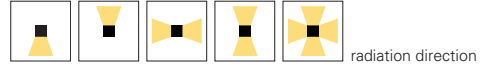
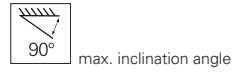
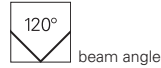

MOUNTING

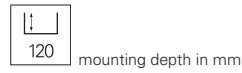
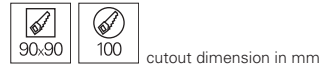

SURFACE

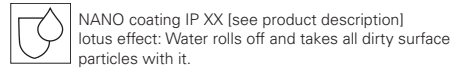

CONTROL



dim to warm function



radio frequency control



Bluetooth control



WiFi control



movement sensor [IR / HF]



DMX control



signal cable



dimnable



number of channels

SAFETY



IP protection class



IK value



walkable



passable



safety lamp control gear



components may be installed on fixtures of materials,
the fire behavior of which is not always known.



max. surface temperature
of lamp control gear



protection class I



protection class II
[protective isolation]



protection class III
[protective low voltage]



no cool beam
In lamps identified as such,
no cold light mirror lamps may be installed.

0	100153.....	167	151WDL.....	776	180207.....	764	
000097.....	726	100200.....	787	162044.....	775	180208.....	767
000099.....	726	100202.....	796	162046.....	775	180209.....	767
000103.....	726	100204.....	796	162047.....	775	180212.....	768
000104.....	726	100238.....	432	162048.....	775	180213.....	764
000106.....	726	100250.....	787	162054.....	775	180214.....	771
000107.....	726	100301.....	796	162055.....	775	180216.....	769
000109.....	726	100484.....	782	180049.....	767	180219.....	765
000140.....	726	110000.....	98	180050.....	767	180236.....	766
000141.....	726	110001.....	98	180051.....	767	180237.....	766
000142.....	726	110002.....	98	180053.....	767	180238.....	769
001621.....	337	110003.....	99	180055.....	770	180239.....	771
001623.....	337	110004.....	99	180058.....	772	180512.....	713
050100.....	788	110007.....	99	180059.....	772	180513.....	713
050200.....	788	110010.....	100	180060.....	772	180514.....	713
050222.....	788	110011.....	101	180061.....	772	180515.....	725
053001.....	788	110014.....	102	180062.....	772	180529.....	725
071DDL.....	776	110015.....	102	180063.....	772	180704.....	794
071NDL.....	776	110016.....	102	180064.....	772	180705.....	794
071WDL.....	776	110017.....	103	180065.....	772	180706.....	794
		110018.....	103	180066.....	772		
		110019.....	103	180067.....	772	3	
1		110020.....	103	180068.....	772	332269.....	774
100028.....	432	110021.....	103	180069.....	772	332270.....	774
100032.....	166	110022.....	103	180070.....	773	332271.....	774
100078.....	164	110027.....	97	180071.....	773	341010.....	192
100079.....	164	110028.....	97	180097.....	774	341033.....	192
100084.....	159	110029.....	97	180099.....	767	341035.....	193
100088.....	159	110030.....	97	180113.....	768	341057.....	194
100089.....	159	110032.....	94	180136.....	773	341062.....	193
100108.....	498	110033.....	94	180139.....	767	341065.....	194
100109.....	498	110034.....	94	180149.....	767	341105.....	193
100111.....	483	110035.....	94	180163.....	768	341176.....	189
100112.....	483	110036.....	94	180166.....	768	341177.....	189
100114.....	484	110037.....	94	180167.....	765	341178.....	188
100116.....	484	110100.....	104	180168.....	765	341180.....	184
100122.....	159	110101.....	104	180174.....	765	341183.....	182
100123.....	162	110222.....	95	180175.....	765	341184.....	182
100124.....	163	110421.....	105	180176.....	765	341185.....	182
100125.....	162	110427.....	105	180177.....	765	341187.....	188
100133.....	485	110500.....	106	180179.....	770	341188.....	174
100138.....	163	110501.....	106	180183.....	765	341189.....	174
100139.....	162	110503.....	106	180187.....	770	341190.....	174
100140.....	156	111821.....	105	180193.....	764	341194.....	174
100141.....	156	122416.....	80	180194.....	770	341195.....	174
100142.....	157	122417.....	80	180195.....	774	341196.....	174
100143.....	156	122420.....	107	180196.....	774	341197.....	176
100144.....	156	126070.....	107	180197.....	765	341198.....	176
100145.....	157	126073.....	107	180198.....	770	341200.....	180
100146.....	158	126074.....	107	180199.....	769	341201.....	180
100147.....	158	131005.....	458	180202.....	766	341202.....	180
100148.....	159	131006.....	458	180203.....	767	341203.....	180
100149.....	156	150921.....	727	180204.....	767	341205.....	191
100150.....	156	151DDL.....	776	180205.....	771	341206.....	191
100151.....	158	151NDL.....	776	180206.....	764	341207.....	178
100152.....	167						

341208.....	178	342121.....	32	342199.....	41	346027.....	215
341209.....	179	342128.....	17	342200.....	41	346028.....	215
341210.....	179	342129.....	11	342201.....	39	346029.....	215
341215.....	173	342130.....	11	342202.....	39	346030.....	215
341216.....	172	342131.....	11	342203.....	39	346031.....	215
341217.....	172	342132.....	11	342204.....	39	346032.....	344
341222.....	190	342133.....	11	342205.....	39	346033.....	344
341223.....	194	342134.....	11	342206.....	39	346034.....	344
341224.....	190	342135.....	11	342207.....	39	346035.....	344
341225.....	192	342136.....	11	342208.....	39	346036.....	344
341228.....	207	342137.....	36	342209.....	39	346037.....	344
341229.....	207	342138.....	36	342210.....	39	346038.....	348
341232.....	173	342142.....	20	342211.....	39	346039.....	348
341236.....	205	342143.....	20	342212.....	39	346040.....	348
341237.....	205	342144.....	22	342213.....	14	346041.....	346
341242.....	205	342145.....	22	342214.....	14	346043.....	346
341243.....	205	342146.....	251	342215.....	15	346044.....	220
341244.....	396	342147.....	251	342216.....	15	348001.....	81
341245.....	396	342148.....	45	342217.....	15	348002.....	81
341248.....	196	342149.....	45	342218.....	15	348004.....	81
342024.....	17	342150.....	45	342219.....	255	348005.....	81
342025.....	24	342151.....	45	342220.....	255	348007.....	428
342026.....	24	342158.....	252	342221.....	255	348009.....	428
342027.....	25	342159.....	170	343016.....	261	348011.....	428
342028.....	25	342160.....	170	343017.....	218	348013.....	82
342029.....	24	342169.....	46	343020.....	216	348022.....	80
342030.....	24	342170.....	9	343021.....	216	348023.....	80
342031.....	25	342171.....	9	343022.....	259	348024.....	80
342032.....	25	342172.....	9	343023.....	263	348025.....	80
342049.....	34	342173.....	9	343024.....	263	348045.....	426
342050.....	34	342174.....	9	343025.....	210	348046.....	426
342051.....	34	342175.....	9	343026.....	210	348048.....	82
342052.....	34	342176.....	9	343028.....	213	348049.....	82
342053.....	34	342177.....	13	343029.....	213	348051.....	64
342054.....	34	342178.....	13	343030.....	257	348052.....	64
342089.....	253	342179.....	13	343031.....	220	348069.....	428
342090.....	253	342180.....	13	343032.....	257	348070.....	428
342091.....	253	342181.....	13	343033.....	263	348071.....	429
342092.....	253	342182.....	13	343034.....	257	348072.....	429
342093.....	253	342183.....	43	343035.....	257	348073.....	70
342094.....	253	342184.....	43	343036.....	265	348074.....	70
342095.....	16	342185.....	43	346003.....	216	348075.....	71
342096.....	16	342186.....	43	346004.....	216	348076.....	72
342101.....	18	342187.....	43	346009.....	352	348077.....	72
342102.....	18	342188.....	43	346010.....	218	348078.....	73
342103.....	18	342189.....	41	346011.....	351	348085.....	74
342104.....	18	342190.....	41	346012.....	351	348086.....	74
342109.....	30	342191.....	41	346013.....	351	348087.....	75
342114.....	28	342192.....	41	346014.....	351	348099.....	83
342115.....	28	342193.....	41	346015.....	210	348107.....	77
342116.....	26	342194.....	41	346016.....	210	348120.....	427
342117.....	26	342195.....	41	346017.....	212	348121.....	427
342118.....	32	342196.....	41	346018.....	212	348122.....	78
342119.....	32	342197.....	41	346025.....	344	348123.....	78
342120.....	32	342198.....	41	346026.....	215	348124.....	76

348125.....	76	348193.....	61	563009.....	200	565221.....	153
348127.....	79	348194.....	61	565007.....	136	565224.....	134
348128.....	83	348195.....	61	565010.....	136	565229.....	118
348138.....	275	348196.....	61	565067.....	108	565230.....	118
348139.....	275	348197.....	61	565068.....	108	565231.....	118
348140.....	282	348198.....	59	565070.....	108	565232.....	118
348141.....	67	348199.....	59	565071.....	108	565233.....	119
348142.....	67	348200.....	59	565082.....	116	565234.....	119
348143.....	67	348201.....	59	565083.....	116	565235.....	119
348144.....	67	348202.....	59	565084.....	116	565236.....	119
348145.....	67	348203.....	59	565085.....	116	565237.....	126
348146.....	67	348204.....	59	565088.....	116	565240.....	126
348147.....	89	348205.....	59	565089.....	116	565241.....	126
348151.....	283	348206.....	59	565090.....	116	565244.....	126
348152.....	282	348207.....	59	565091.....	116	565245.....	127
348153.....	84	348208.....	59	565094.....	116	565246.....	127
348154.....	84	348209.....	59	565095.....	116	565247.....	123
348155.....	85	348210.....	77	565096.....	116	565248.....	117
348156.....	85			565097.....	116	565250.....	144
348157.....	85	4		565102.....	117	565251.....	144
348158.....	85	401003.....	69	565103.....	117	565252.....	145
348159.....	85	401004.....	69	565108.....	120	565253.....	146
348160.....	85	401005.....	69	565109.....	120	565254.....	146
348161.....	86	401006.....	69	565110.....	120	565255.....	147
348162.....	86	401007.....	69	565111.....	120	565256.....	148
348163.....	87	401008.....	69	565152.....	139	565257.....	148
348164.....	87	401009.....	52	565153.....	139	565258.....	149
348165.....	87	401010.....	52	565154.....	139	565261.....	135
348166.....	87	401011.....	279	565155.....	139	565262.....	128
348167.....	87	401012.....	279	565156.....	139	565263.....	128
348168.....	87	401013.....	279	565157.....	139	565264.....	128
348169.....	70	401014.....	279	565158.....	139	565265.....	128
348170.....	70	401015.....	279	565159.....	139	565278.....	129
348171.....	71	401016.....	279	565160.....	139	565279.....	129
348172.....	72	449200.....	95	565161.....	139	565280.....	129
348173.....	72	449201.....	95	565162.....	139	565281.....	129
348174.....	73	449202.....	95	565163.....	139	565282.....	129
348175.....	76	449210.....	96	565172.....	120	565283.....	129
348176.....	79	449211.....	96	565173.....	120	565284.....	129
348177.....	78	449212.....	96	565180.....	136	565285.....	129
348178.....	78			565181.....	136	565299.....	130
348179.....	76	5		565182.....	137	565300.....	130
348180.....	63	501000.....	776	565183.....	137	565301.....	130
348181.....	63	501001.....	776	565184.....	137	565302.....	130
348182.....	63	501002.....	776	565185.....	137	565303.....	130
348183.....	63	501003.....	776	565192.....	133	565304.....	130
348184.....	63	501004.....	776	565193.....	121	565305.....	130
348185.....	63	501008.....	776	565194.....	121	565306.....	130
348186.....	61	501011.....	776	565195.....	123	565307.....	131
348187.....	61	501012.....	776	565198.....	121	565308.....	131
348188.....	61	501013.....	776	565200.....	124	565309.....	131
348189.....	61	501032.....	777	565201.....	124	565310.....	131
348190.....	61	501033.....	777	565202.....	124	565315.....	111
348191.....	61	561201.....	723	565203.....	124	565316.....	112
348192.....	61	561202.....	723	565220.....	153	565317.....	112

565318.....	113	620033	55	620135.....	186	688037.....	240
565320.....	138	620034	55	620136.....	182	688038.....	242
565321.....	138	620035	55	620137.....	182	688039.....	242
565322.....	138	620036	55	620138.....	182	688040.....	242
565323.....	138	620037	55	620139.....	182	688041.....	242
565325.....	287	620038	55	620140.....	182	688042.....	242
565326.....	286	620039	55	666662.....	766	688043.....	242
565327.....	114	620040	55	666663.....	766	688044.....	242
565328.....	115	620041	56	666664.....	766	688045.....	242
565329.....	115	620042	56	686864.....	94		
565332.....	113	620043	56	686867.....	94	7	
565335.....	131	620044	56	686868.....	94	700229	805
565336.....	131	620045	56	686869.....	94	700230	805
565337.....	132	620046	56	686871.....	94	707015	324
565338.....	132	620047	56	686880.....	94	707034.....	324
565339.....	132	620048	56	686940.....	234	707036.....	328
565342.....	141	620049	57	687034.....	228	707037.....	328
565343.....	140	620050	57	687035.....	229	707038.....	328
565344.....	141	620051	57	687062.....	224	707039.....	328
565351.....	141	620052	57	687063.....	233	707040.....	329
565352.....	142	620053	57	687064.....	224	707041.....	329
565353.....	142	620054	57	687065.....	232	707042.....	329
565354.....	141	620055	57	687070.....	224	707043.....	329
565355.....	125	620056	57	687071.....	224	707044.....	336
565356.....	125	620057	247	687072.....	224	707045.....	324
565357.....	125	620102	247	687073.....	224	707046.....	324
565358.....	125	620103	247	687074.....	225	707047.....	324
565359.....	125	620104	249	687075.....	225	707048.....	324
565360.....	125	620105	247	687076.....	225	707054.....	328
565361.....	140	620106	247	687077.....	225	707055.....	328
565362.....	111	620107	247	687078.....	225	707056.....	329
565363.....	112	620108	247	687079.....	225	707057.....	329
565364.....	112	620109	247	687095.....	235	707067.....	331
565365.....	113	620110	247	687096.....	226	707068.....	331
565366.....	113	620111	249	687117	224	707069.....	330
565367.....	138	620112	249	687118	224	707070.....	330
565368.....	138	620113	249	687130.....	230	707079.....	325
565369.....	138	620114	249	687131.....	231	707080.....	325
565370.....	138	620115	249	688003	234	707081.....	325
		620116	249	688008	519	707082.....	337
6		620117	249	688019.....	519	707083.....	337
620006	227	620118	249	688020.....	518	707084.....	324
620007	227	620119	322	688021.....	518	707085.....	324
620012	228	620120	322	688024.....	519	707086.....	324
620013	228	620123	399	688025.....	239	707087.....	324
620014	229	620124	399	688026.....	239	707088.....	324
620015	229	620125	399	688027.....	239	707089.....	324
620016	230	620126	399	688028.....	239	707090.....	327
620017	230	620127	399	688029.....	240	707091.....	327
620018	231	620128	399	688030.....	240	707092.....	327
620019	231	620129	399	688031.....	240	707093.....	327
620020	232	620130	399	688033.....	240	707094.....	326
620021	233	620132	186	688034.....	240	707095.....	326
620031	252	620133	186	688035.....	240	707096.....	326
620032	252	620134	186	688036.....	240	707097.....	326

707098.....	326	710012.....	301	710071.....	299	730340.....	478
707099.....	326	710013.....	301	710077.....	307	730349.....	805
707100.....	326	710014.....	301	710078.....	309	730354.....	377
707101.....	326	710015.....	303	710079.....	307	730355.....	414
707102.....	326	710016.....	303	710082.....	311	730364.....	375
707103.....	326	710017.....	303	710083.....	311	730365.....	375
707104.....	326	710018.....	303	710084.....	309	730380.....	408
707105.....	326	710019.....	303	710085.....	309	730381.....	412
707106.....	326	710020.....	303	710086.....	309	730382.....	412
707107.....	326	710024.....	316	710087.....	309	730395.....	405
707108.....	326	710026.....	316	710088.....	309	730407.....	426
707109.....	326	710027.....	305	710089.....	301	730408.....	426
707110.....	323	710028.....	305	710090.....	302	730409.....	426
707111.....	323	710029.....	305	710091.....	304	730410.....	426
707112.....	323	710030.....	305	710092.....	306	730419.....	277
707113.....	323	710031.....	305	710093.....	305	730420.....	490
707114.....	323	710032.....	305	710094.....	310	730421.....	490
707115.....	323	710033.....	306	710095.....	310	730424.....	277
707116.....	332	710034.....	306	710096.....	310	730425.....	277
707117.....	332	710035.....	306	710097.....	314	730432.....	499
707118.....	333	710036.....	304	710098.....	314	730434.....	499
707119.....	333	710037.....	304	710099.....	314	730436.....	501
707120.....	333	710038.....	304	730007.....	365	730437.....	501
707121.....	333	710039.....	302	730008.....	500	730438.....	481
707122.....	333	710040.....	302	730009.....	364	730439.....	481
707123.....	333	710041.....	302	730032.....	365	730447.....	480
707124.....	334	710042.....	302	730034.....	392	730449.....	495
707125.....	334	710043.....	302	730199.....	493	730450.....	278
707126.....	334	710044.....	302	730209.....	492	730454.....	495
707127.....	334	710045.....	300	730211.....	486	730455.....	278
707128.....	334	710046.....	300	730238.....	458	730459.....	482
707129.....	334	710047.....	300	730244.....	494	730464.....	511
707130.....	321	710048.....	310	730248.....	492	730465.....	511
707131.....	336	710049.....	310	730249.....	487	730466.....	511
707132.....	335	710050.....	310	730250.....	487	730468.....	481
707133.....	335	710051.....	313	730255.....	485	730469.....	481
707134.....	321	710052.....	313	730262.....	499	730470.....	478
707135.....	321	710053.....	313	730263.....	500	730474.....	476
707136.....	321	710054.....	316	730266.....	491	730475.....	476
707137.....	321	710055.....	316	730267.....	491	730476.....	476
707138.....	321	710056.....	316	730275.....	803	730477.....	476
707139.....	321	710057.....	308	730276.....	494	730478.....	477
707140.....	321	710058.....	308	730289.....	488	730479.....	477
710000.....	299	710059.....	308	730292.....	499	731005.....	390
710001.....	299	710060.....	317	730296.....	488	731006.....	390
710002.....	299	710061.....	317	730300.....	793	731007.....	390
710003.....	299	710062.....	317	730301.....	793	731008.....	391
710004.....	299	710063.....	308	730328.....	408	731009.....	391
710005.....	299	710064.....	308	730329.....	408	731010.....	391
710006.....	299	710065.....	308	730330.....	415	731011.....	391
710007.....	299	710066.....	307	730331.....	415	731014.....	412
710008.....	299	710067.....	307	730332.....	369	731015.....	409
710009.....	301	710068.....	307	730333.....	369	731016.....	400
710010.....	301	710069.....	299	730336.....	483	731019.....	409
710011.....	301	710070.....	299	730339.....	478	731020.....	409

731021.....	407	732050.....	497	733008.....	375	800023.....	799
731024.....	409	732064.....	512	733012.....	364	800024.....	799
731025.....	409	732071.....	470	733018.....	369	800025.....	799
731026.....	409	732072.....	471	733027.....	443	800026.....	799
731029.....	409	732074.....	467	733028.....	364	800027.....	799
731030.....	409	732075.....	467	733032.....	443	800028.....	799
731031.....	393	732076.....	467	733033.....	374	800029.....	799
731033.....	416	732079.....	470	733034.....	374	800030.....	727
731052.....	427	732080.....	471	733035.....	374	800033.....	799
731053.....	427	732084.....	271	733037.....	379	800036.....	799
731059.....	392	732085.....	271	733038.....	379	800100.....	798
731060.....	415	732093.....	459	733039.....	379	800105.....	798
731068.....	405	732094.....	459	733040.....	370	800106.....	798
731071.....	407	732095.....	459	733041.....	370	800107.....	798
731072.....	407	732096.....	514	733042.....	370	800108.....	798
731087.....	414	732097.....	514	733043.....	372	800109.....	798
731088.....	414	732098.....	514	733044.....	372	800111.....	798
731098.....	459	732099.....	514	733045.....	372	800112.....	798
731099.....	411	732100.....	514	733046.....	357	800114.....	798
731100.....	411	732101.....	514	733047.....	374	800115.....	798
731102.....	420	732102.....	514	733048.....	374	800116.....	798
731109.....	421	732103.....	514	733049.....	355	819066.....	794
731112.....	400	732104.....	461	733050.....	355	819067.....	794
731113.....	419	732105.....	512	733051.....	358	819070.....	794
731116.....	357	732108.....	462	733054.....	449	819071.....	794
731118.....	417	732109.....	463	733055.....	449	819072.....	794
731119.....	423	732110.....	464	733056.....	382	829063.....	100, 101, 102, 103, 104, 105, 106, 107, 108, 120, 121, 123, 124, 126, 127, 128, 129, 130, 131, 785, 94, 95, 96, 97, 98, 99
731122.....	355	732123.....	462	733057.....	385	836011.....	442
731124.....	418	732124.....	463	733058.....	385	836012.....	443
731127.....	408	732125.....	464	733059.....	456	836013.....	443
731128.....	408	732126.....	457	733060.....	456	836014.....	442
731129.....	416	732127.....	462	733061.....	367	836015.....	443
731130.....	406	732128.....	463	733062.....	366	836016.....	443
731131.....	406	732129.....	464	733063.....	366	836018.....	444
731132.....	394	732134.....	461	733064.....	453	836019.....	444
731133.....	404	732136.....	465	733065.....	453	836020.....	445
731134.....	416	732137.....	465	733066.....	450	836930.....	442
731135.....	416	732138.....	269	733067.....	451	836931.....	442
731136.....	416	732139.....	269	733068.....	380	836934.....	443
731137.....	395	732140.....	269	733069.....	380	836935.....	443
731138.....	403	732141.....	269	740005.....	506	836958.....	442
731139.....	403	732142.....	269	740006.....	507	836960.....	443
731140.....	403	732143.....	496	740007.....	504	836961.....	443
731141.....	403	732147.....	510	763004.....	434	836962.....	443
731142.....	284	732148.....	510	763005.....	434	836963.....	443
731143.....	285	732149.....	510	763006.....	434	840097.....	657
731144.....	404	732150.....	510	763007.....	434	840122.....	652
732014.....	466	732151.....	510	763011.....	434	840124.....	652
732016.....	466	732152.....	510	763012.....	434	840142.....	657
732036.....	458	732153.....	510	763025.....	436	840144.....	667
732037.....	458	732154.....	510	763026.....	438		
732041.....	514	732155.....	510	785016.....	505		
732043.....	514	733004.....	376	785017.....	505		
732045.....	514	733006.....	375				
732049.....	496	733007.....	377				

840147.....	664	840349.....	660	843274.....	707, 757	862191.....	719
840158.....	649	840350.....	659	843275.....	707, 757	862192.....	719
840159.....	649	840351.....	665	843335.....	755	862193.....	719
840164.....	647	840352.....	664	843336.....	755	862194.....	719
840165.....	647	840353.....	668	843337.....	755	862196.....	713
840166.....	647	840373.....	669	861203.....	748	862197.....	713
840167.....	647	840374.....	643	862037.....	224, 225	862198.....	713
840172.....	647	840375.....	645	862038.....	224, 225	862199.....	713
840175.....	650	840376.....	679	862048.....	712	862201.....	713
840178.....	650	840378.....	659	862049.....	712	862202.....	715
840179.....	650	840379.....	660	862050.....	712	862203.....	715
840180.....	650	840386.....	685	862074.....	224, 225	862204.....	715
840186.....	653	840387.....	685	862093.....	697	862205.....	715
840187.....	653	840388.....	685	862094.....	697	862207.....	715
840192.....	651	840389.....	685	862121.....	697	862208.....	715
840193.....	651	840390.....	685	862122.....	697	862209.....	715
840194.....	651	840391.....	685	862123.....	697	862210.....	715
840210.....	650	843000.....	750	862124.....	697	862211.....	715
840236.....	667	843001.....	749	862125.....	697	862212.....	711
840239.....	669	843003.....	750	862126.....	697	862220.....	701
840254.....	663	843004.....	751	862127.....	698	862221.....	701
840256.....	665	843005.....	748	862128.....	711	862222.....	701
840267.....	650	843007.....	734	862129.....	711	862223.....	712
840276.....	663	843008.....	740	862130.....	712	862225.....	712
840283.....	680	843010.....	759	862132.....	712	862229.....	696
840285.....	671	843011.....	740	862133.....	713	862230.....	696
840286.....	675	843018.....	744	862136.....	715	862232.....	697
840287.....	681	843019.....	744	862138.....	715	862233.....	697
840288.....	673	843020.....	745	862141.....	717	862234.....	697
840289.....	677	843021.....	745	862142.....	717	862235.....	715
840290.....	683	843033.....	783	862157.....	713	862236.....	715
840291.....	649	843037.....	741	862160.....	703, 704	862237.....	715
840293.....	804	843042.....	783	862161.....	703, 704	862238.....	712
840294.....	804	843043.....	783	862162.....	698	862239.....	712
840295.....	804	843044.....	784	862163.....	698	862240.....	701
840296.....	639	843045.....	785	862164.....	698	862241.....	701
840304.....	639	843046.....	753	862165.....	698	862242.....	701
840308.....	668	843047.....	752	862166.....	698	862243.....	722
840309.....	668	843049.....	741	862167.....	698	862244.....	722
840317.....	655	843050.....	741	862168.....	698	862245.....	722
840318.....	655	843051.....	758	862172.....	697	862246.....	720
840319.....	655	843052.....	758	862173.....	697	862247.....	720
840320.....	655	843053.....	735	862174.....	721	862248.....	720
840321.....	640	843054.....	757	862175.....	721	862249.....	706
840322.....	640	843055.....	785	862176.....	721	862250.....	706
840323.....	639	843056.....	742	862180.....	315	862251.....	706
840324.....	639	843057.....	742	862181.....	315	862252.....	706
840331.....	652	843058.....	743	862182.....	315	862253.....	704
840332.....	652	843059.....	743	862183.....	315	862254.....	704
840333.....	653	843060.....	756	862184.....	315	862255.....	704
840334.....	653	843061.....	737	862185.....	315	862256.....	704
840337.....	655	843069.....	738	862187.....	725	862257.....	716
840338.....	655	843268.....	754	862188.....	725	862258.....	716
840339.....	655	843269.....	754	862189.....	725	862259.....	716
840340.....	655	843273.....	756	862190.....	719	872011.....	702

872014.....	714	872628.....	712	930220.....	145, 147, 149	930332.....	141, 78
872026.....	711	872629.....	697	930230.....	153	930333.....	141, 78
872045.....	700	872630.....	697	930242.....	224, 225	930335.....	173, 336, 77
872046.....	700	872632.....	697	930243.....	224	930337.....	140, 173, 336, 77
872065.....	711	872634.....	712	930244.....	225	930339.....	140, 173, 336, 77
872082.....	698	872647.....	715	930245.....	225	930340.....	140, 173, 336, 77
872083.....	698	872817.....	702	930246.....	225	930341.....	140, 173, 336, 77
872084.....	698	882271.....	752, 753, 794	930247.....	225	930345.....	804
872085.....	698	882272.....	794	930248.....	225	930346.....	804
872086.....	698			930249.....	225	930347.....	804
872087.....	698	9		930250.....	225	930348.....	804
872088.....	698	920132.....	784	930251.....	225	930349.....	804
872089.....	698	930001.....	787	930252.....	135	930350.....	804
872091.....	698	930006.....	787	930253.....	135	930363.....	329
872093.....	698	930007.....	511	930254.....	135	930364.....	328
872094.....	698	930036.....	784	930255.....	135	930365.....	329
872097.....	699	930060.....	782	930256.....	135	930366.....	325, 328
872098.....	699	930071.....	277, 278	930257.....	135	930371.....	140, 173, 336, 77
872099.....	699	930072.....	277, 278	930270.....	123	930381.....	141, 78
872100.....	699	930074.....	101, 133	930271.....	123	930382.....	141, 79
872101.....	699	930075.....	101, 133	930293.....	271	930386.....	323
872102.....	699	930076.....	101, 133	930295.....	271	930387.....	323
872103.....	699	930077.....	101, 133	930297.....	328	930388.....	323
872104.....	699	930078.....	101, 133	930298.....	328	930390.....	141, 79
872105.....	699	930079.....	101, 133	930299.....	328	930392.....	141, 79
872106.....	699	930084.....	142	930300.....	328	930394.....	79
872107.....	699	930085.....	142	930301.....	325, 328	930396.....	141, 79
872108.....	699	930087.....	142	930302.....	325, 328	930398.....	141, 79
872109.....	706	930088.....	142	930303.....	325, 328	930399.....	141, 79
872110.....	706	930089.....	143	930306.....	140, 173, 328, 336, 77	930402.....	801
872111.....	706	930090.....	143	930307.....	140, 173, 328, 336, 77	930405.....	804
872112.....	706	930091.....	143	930308.....	140, 173, 328, 336, 77	930406.....	804
872113.....	706	930092.....	143	930309.....	140, 173, 328, 336, 77	930410.....	514
872114.....	706	930093.....	143	930310.....	140, 173, 328, 336, 77	930411.....	514
872115.....	706	930094.....	143	930311.....	329	930413.....	437
872116.....	699	930095.....	143	930312.....	329	930414.....	437
872117.....	703	930096.....	143	930313.....	329	930415.....	437
872118.....	705	930097.....	143	930314.....	329	930416.....	437
872119.....	699	930099.....	101, 133	930315.....	329	930417.....	437
872120.....	703	930100.....	101, 133	930316.....	329	930418.....	437
872121.....	705	930103.....	807	930317.....	329	930419.....	437
872122.....	699	930104.....	807	930318.....	329	930420.....	437
872123.....	703	930105.....	807	930320.....	329	930421.....	437
872124.....	705	930160.....	224	930321.....	329	930422.....	437
872125.....	699	930167.....	153	930322.....	329	930423.....	437
872126.....	703	930191.....	224	930323.....	329	930424.....	437
872127.....	696	930209.....	224	930324.....	329	930426.....	461, 462, 805
872128.....	696	930212.....	224	930327.....	78	930427.....	463, 464, 465, 805
872131.....	711	930213.....	224	930329.....	141, 78	930428.....	461
872132.....	714	930214.....	224, 225	930331.....	141, 78		
872134.....	714	930215.....	144, 146, 148				
872135.....	701	930216.....	144, 146, 148				
872136.....	701	930217.....	145, 147, 149				
872137.....	701	930218.....	144, 146, 148				
872138.....	701	930219.....	144, 146, 148				

930430.....	461	930505.....	201	930631.....	345	940010.....	793
930431.....	462	930512.....	650	930632.....	282, 283	940029.....	792
930432.....	462	930513.....	650	930633.....	282, 283	940030.....	792
930434.....	463	930514.....	651	930634.....	282, 283	940031.....	792
930435.....	463	930515.....	651	930641.....	269	940032.....	789
930437.....	464	930516.....	664	930642.....	269	940033.....	792
930438.....	464	930517.....	667	930647.....	52	940034.....	792
930441.....	462	930530.....	679, 680	930652.....	111	940035.....	792
930442.....	463, 464	930531.....	671, 675	930653.....	112	940036.....	789
930443.....	679, 680	930532.....	681, 683	930654.....	112	940037.....	792
930444.....	679, 680	930533.....	673, 677	930655.....	113	940038.....	792
930445.....	671, 675	930544.....	322, 83	930656.....	113	940039.....	792
930446.....	671, 675	930545.....	322, 83	930659.....	805	940040.....	789
930447.....	681, 683	930546.....	322, 83	930663.....	806	940041.....	793
930448.....	673, 677	930558.....	465	930664.....	156, 158, 159	940042.....	793
930449.....	673, 677	930567.....	465	930665.....	156, 157, 158, 159, 162, 163, 164, 166, 167	940043.....	793
930451.....	681, 683	930568.....	465	930666.....	156, 157, 158, 159, 162, 163, 164	940044.....	789
930460.....	738	930569.....	465	930667.....	156, 158, 159	940045.....	793
930461.....	439	930571.....	801	930668.....	156, 157, 158, 159	940046.....	793
930468.....	439	930573.....	801	930669.....	156, 157, 158, 159	940047.....	793
930469.....	439	930574.....	803	930670.....	162, 163, 164, 166, 167	940048.....	789
930470.....	439	930575.....	802	930671.....	162, 163, 164	940049.....	793
930471.....	439	930576.....	802	930672.....	162, 163	940050.....	793
930472.....	439	930577.....	322, 83	930673.....	162	940051.....	793
930473.....	439	930578.....	802	930674.....	156, 157, 158, 159, 162, 163	940052.....	789
930474.....	439	930583.....	805	930675.....	162	940056.....	791
930475.....	439	930584.....	805	930676.....	156, 157, 158, 159	940057.....	791
930476.....	439	930585.....	805	930677.....	333	940058.....	791
930477.....	439	930586.....	805	930678.....	333	940059.....	791
930478.....	439	930587.....	462, 463, 464, 465, 797	930679.....	13, 332, 334, 84, 86	940060.....	791
930480.....	200	930590.....	269	930680.....	13, 333, 334, 85, 87	940061.....	791
930481.....	201	930593.....	671, 673, 675, 677, 679, 680, 681, 683, 685, 806	930681.....	13, 333, 334, 85, 87	940062.....	791
930482.....	200	930611.....	344	930682.....	333, 85, 87	940063.....	791
930483.....	200	930612.....	344	930684.....	333, 85, 87	940064.....	789
930484.....	200	930613.....	344	930685.....	269	940065.....	789
930485.....	200	930614.....	344	930686.....	269	940066.....	789
930486.....	200	930615.....	344	930687.....	269	940067.....	789
930487.....	200	930616.....	344	930688.....	162	970000.....	534
930488.....	200	930617.....	344	930689.....	685	970001.....	534
930489.....	200	930618.....	345	930690.....	685	970003.....	534
930490.....	200	930619.....	345	930691.....	685	970005.....	534
930491.....	200	930620.....	345	930692.....	685	970007.....	534
930492.....	200	930621.....	345	930693.....	685	970008.....	534
930493.....	200	930622.....	345	930694.....	797	970020.....	536
930494.....	201	930623.....	345			970021.....	536
930495.....	201	930624.....	345			970023.....	536
930496.....	201	930625.....	345			970025.....	536
930497.....	201	930626.....	345			970027.....	536
930498.....	201	930627.....	345			970028.....	536
930499.....	201	930628.....	345			970029.....	536
930500.....	201	930629.....	345			970040.....	538
930501.....	201	930630.....	345			970041.....	538
930502.....	201					970043.....	538
930503.....	201					970045.....	538
930504.....	201					970047.....	538

970048	538	970437	578	975161	552	978042	535
970060	540	970438	578	975163	552	978050	537
970061	540	970460	570	975165	552	978051	537
970063	540	970470	572	975168	552	978052	537
970065	540	970502	566	975181	544	978060	539
970068	540	970503	566	975183	544	978061	539
970080	532	970520	568	975185	544	978062	539
970081	532	970522	568	975231	560	978070	541
970083	532	970523	568	975331	602	978071	541
970085	532	970550	584	975334	602	978072	541
970100	534	970551	584	975341	608	978080	547
970101	534	970560	586	975344	608	978081	547
970103	534	970561	586	975351	612	978082	547
970105	534	970570	588	975353	612	978090	549
970108	534	970571	588	975360	604	978091	549
970120	536	970600	574	975361	604	978092	549
970121	536	970601	574	975365	604	978100	551
970123	536	970602	574	975371	610	978101	551
970125	536	970723	618	975375	610	978102	551
970128	536	970724	618	975381	614	978110	553
970129	536	970741	622	975385	614	978111	553
970140	538	970762	595, 597, 627	975390	606	978112	553
970141	538	970764	623, 625	975391	606	978120	547
970143	538	970770	557	975394	606	978121	547
970145	538	975001	546	975395	606	978122	547
970147	538	975003	546	975411	582	978130	549
970148	538	975005	546	975412	582	978131	549
970160	540	975008	546	975471	594	978132	549
970161	540	975021	548	975475	594	978140	551
970163	540	975023	548	975476	594	978141	551
970165	540	975025	548	975483	596	978142	551
970168	540	975028	548	975485	596	978150	553
970180	532	975029	548	975486	596	978151	553
970181	532	975041	550	975491	592	978152	553
970183	532	975043	550	975495	592	978161	543
970185	532	975045	550	975496	592	978170	581
970201	542	975061	552	975501	598	978171	581
970202	542	975063	552	975723	620	978175	599
970231	558	975065	552	975724	620	978191	567
970261	556	975081	544	975741	624	978201	569
970262	556	975083	544	975781	626	978211	603
970280	562	975085	544	978000	535	978221	609
970281	562	975101	546	978001	535	978231	613
970284	562	975103	546	978002	535	978241	575
970285	562	975105	546	978010	537	978242	575
970301	576	975108	546	978011	537	978250	593
970303	576	975121	548	978012	537	978251	593
970305	576	975123	548	978020	539	978252	593
970308	576	975125	548	978021	539	978260	595
970401	580	975128	548	978022	539	978261	595
970403	580	975129	548	978030	541	978270	597
970404	580	975141	550	978031	541	978271	597
970431	578	975143	550	978032	541	978291	559
970433	578	975145	550	978040	535	978301	561
970434	578	975148	550	978041	535	978311	557

978341.....	583	978661.....	533	979130.....	553	979590.....	541
978351.....	543	978662.....	533	979131.....	553	979591.....	541
978361.....	543	978670.....	533	979132.....	553	979592.....	541
978370.....	585	978671.....	533	979140.....	547	979600.....	535
978380.....	587	978672.....	533	979141.....	547	979601.....	535
978390.....	589	978680.....	545	979142.....	547	979602.....	535
978500.....	535	978681.....	545	979150.....	553	979610.....	541
978501.....	535	978682.....	545	979151.....	553	979611.....	541
978502.....	535	978690.....	545	979152.....	553	979612.....	541
978510.....	537	978691.....	545	979160.....	533	979620.....	547
978511.....	537	978692.....	545	979161.....	533	979621.....	547
978512.....	537	978700.....	577	979162.....	533	979622.....	547
978520.....	539	978701.....	577	979170.....	533	979630.....	553
978521.....	539	978702.....	577	979171.....	533	979631.....	553
978522.....	539	978711.....	559	979172.....	533	979632.....	553
978530.....	541	978721.....	561	979180.....	545	979640.....	547
978531.....	541	979000.....	537	979181.....	545	979641.....	547
978532.....	541	979001.....	537	979182.....	545	979642.....	547
978540.....	535	979002.....	537	979190.....	545	979650.....	553
978541.....	535	979010.....	539	979191.....	545	979651.....	553
978542.....	535	979011.....	539	979192.....	545	979652.....	553
978550.....	537	979012.....	539	979200.....	595	979660.....	533
978551.....	537	979020.....	537	979201.....	595	979661.....	533
978552.....	537	979021.....	537	979210.....	597	979662.....	533
978560.....	539	979022.....	537	979211.....	597	979670.....	533
978561.....	539	979030.....	539	979221.....	559	979671.....	533
978562.....	539	979031.....	539	979231.....	561	979672.....	533
978570.....	541	979032.....	539	979241.....	557	979680.....	545
978571.....	541	979040.....	549	979500.....	537	979681.....	545
978572.....	541	979041.....	549	979501.....	537	979682.....	545
978580.....	547	979042.....	549	979502.....	537	979690.....	545
978581.....	547	979050.....	551	979510.....	539	979691.....	545
978582.....	547	979051.....	551	979511.....	539	979692.....	545
978590.....	549	979052.....	551	979512.....	539	979700.....	595
978591.....	549	979060.....	549	979520.....	537	979701.....	595
978592.....	549	979061.....	549	979521.....	537	979710.....	597
978600.....	551	979062.....	549	979522.....	537	979711.....	597
978601.....	551	979070.....	551	979530.....	539	979721.....	559
978602.....	551	979071.....	551	979531.....	539	979731.....	561
978610.....	553	979072.....	551	979532.....	539	979741.....	557
978611.....	553	979080.....	535	979540.....	549	979751.....	579
978612.....	553	979081.....	535	979541.....	549	979760.....	585
978620.....	547	979082.....	535	979542.....	549	979770.....	587
978621.....	547	979090.....	541	979550.....	551	979780.....	589
978622.....	547	979091.....	541	979551.....	551	980000.....	537
978630.....	549	979092.....	541	979552.....	551	980001.....	537
978631.....	549	979100.....	535	979560.....	549	980002.....	537
978632.....	549	979101.....	535	979561.....	549	980010.....	537
978640.....	551	979102.....	535	979562.....	549	980011.....	537
978641.....	551	979110.....	541	979570.....	551	980012.....	537
978642.....	551	979111.....	541	979571.....	551	980020.....	563
978650.....	553	979112.....	541	979572.....	551	980021.....	563
978651.....	553	979120.....	547	979580.....	535	980023.....	563
978652.....	553	979121.....	547	979581.....	535	980040.....	549
978660.....	533	979122.....	547	979582.....	535	980041.....	549

980042	549	569, 575, 577, 581, 595,	569, 575, 577, 581, 595,	983527.....	539, 551, 559,
980060	549	597	597		561, 583
980061	549	983018.....	537, 549, 567,	983530.....	541, 553, 573
980062	549	569, 575, 577, 581, 595,	569, 575, 577, 581, 595,	983531.....	541, 553, 573
980501	609	597	597	983532.....	541, 553, 573
980511	613	983020.....	539, 551,	983533.....	541, 553, 573
980541	577	559, 561, 583, 593, 605,	559, 561, 583, 593, 605,	983534.....	541, 553, 573
980550	585	611, 615	611, 615	983535.....	541, 553, 573
980560	587	983021.....	539, 551,	983536.....	541, 553, 573
980570	589	559, 561, 583, 593, 605,	559, 561, 583, 593, 605,	983539.....	541, 553, 573
981001	619	611, 615	611, 615	983550.....	533, 545
981011	621	983022.....	539, 551,	983551.....	533, 545
981021	627	559, 561, 583, 593, 605,	559, 561, 583, 593, 605,	983554.....	533, 545
981031	623	611, 615	611, 615	983555.....	533, 545
981041	625	983023.....	539, 551,	983556.....	533, 545
983000	535, 547, 603,	559, 561, 583, 593, 605,	559, 561, 583, 593, 605,	983560.....	537, 549, 575,
	607, 609, 613	611, 615	611, 615		577, 581
983001	535, 547, 603,	983024.....	539, 551,	983561.....	537, 549, 575,
	607, 609, 613	559, 561, 583, 593, 605,	559, 561, 583, 593, 605,		577, 581
983002	535, 547, 603,	611, 615	611, 615	983562.....	537, 549, 575,
	607, 609, 613	983025.....	539, 551,		577, 581
983003	535, 547, 603,	559, 561, 583, 593, 605,	559, 561, 583, 593, 605,	984002	535, 547, 607
	607, 609, 613	611, 615	611, 615	984003	535, 547, 607
983004	535, 547, 603,	983026.....	539, 551,	984004	535, 547, 607
	607, 609, 613	559, 561, 583, 593, 605,	559, 561, 583, 593, 605,	984005	535, 547, 607
983005	535, 547, 603,	611, 615	611, 615	984010	537, 549, 575,
	607, 609, 613	983027.....	539, 551,		581, 595, 597
983006	535, 547, 603,	559, 561, 583, 593, 605,	559, 561, 583, 593, 605,	984011	537, 549, 575,
	607, 609, 613	611, 615	611, 615		581, 595, 597
983007	535, 547, 603,	983028.....	539, 551,	984012	537, 549, 575,
	607, 609, 613	559, 561, 583, 593, 605,	559, 561, 583, 593, 605,		581, 595, 597
983008	535, 547, 603,	611, 615	611, 615	984013	537, 549, 575,
	607, 609, 613	983030.....	541, 553, 573		581, 595, 597
983010	537, 549, 567,	983031.....	541, 553, 573	984014	537, 549, 575,
	569, 575, 577, 581, 595,	983032.....	541, 553, 573		581, 595, 597
	597	983033.....	541, 553, 573	984015	537, 549, 575,
983011	537, 549, 567,	983034.....	541, 553, 573		581, 595, 597
	569, 575, 577, 581, 595,	983035.....	541, 553, 573	984017	537, 549, 575,
	597	983036.....	541, 553, 573		581, 595, 597
983012	537, 549, 567,	983037.....	541, 553, 573	984018	537, 549, 575,
	569, 575, 577, 581, 595,	983038.....	541, 553, 573		581, 595, 597
	597	983040.....	543, 557, 571,	984022.....	539, 551, 559,
983013	537, 549, 567,		573		561, 583, 605
	569, 575, 577, 581, 595,	983041.....	543, 557, 571,	984023.....	539, 551, 559,
	597		573		561, 583, 605
983014	537, 549, 567,	983044.....	543, 557, 571,	984024.....	539, 551, 559,
	569, 575, 577, 581, 595,		573		561, 583, 605
	597	983045.....	543, 557, 571,	984025.....	539, 551, 559,
983015	537, 549, 567,		573		561, 583, 605
	569, 575, 577, 581, 595,	983046.....	543, 557, 571,	984026.....	539, 551, 559,
	597		573		561, 583, 605
983016	537, 549, 567,	983060.....	537, 549, 567,	984032.....	541, 553, 573
	569, 575, 577, 581, 595,	569, 575, 577, 581, 595,	569, 575, 577, 581, 595,	984033.....	541, 553, 573
	597		597	984034.....	541, 553, 573
983017	537, 549, 567,	983061.....	537, 549, 567,	984035.....	541, 553, 573

984036.....	541, 553, 573	985010.....	537, 549, 581
984044.....	543, 557, 571, 573	985011.....	537, 549, 581
984045.....	543, 557, 571, 573	985016.....	537, 549, 581
984054.....	533, 545	985504.....	609, 613
984055.....	533, 545	985505.....	609, 613
984502.....	535, 547	985508.....	609, 613
984503.....	535, 547	985570.....	585
984504.....	535, 547	985571.....	585
984505.....	535, 547	985580.....	587
984510.....	537, 549, 581, 595, 597	985581.....	587
984511.....	537, 549, 581, 595, 597	985590.....	589
984512.....	537, 549, 581, 595, 597	985591.....	589
984513.....	537, 549, 581, 595, 597	985601.....	599
984514.....	537, 549, 581, 595, 597	985605.....	599
984515.....	537, 549, 581, 595, 597	987002.....	535, 547
984517.....	537, 549, 581, 595, 597	987004.....	537, 549
984518.....	537, 549, 581, 595, 597	987006.....	539, 551, 583
984522.....	539, 551, 559, 561, 583	987008.....	541, 553
984523.....	539, 551, 559, 561, 583	987010.....	543
984524.....	539, 551, 559, 561, 583	987020.....	559, 561, 589, 593, 595
984525.....	539, 551, 559, 561, 583	987025.....	563
984526.....	539, 551, 559, 561, 583	987026.....	563
984532.....	541, 553, 573	987027.....	563
984533.....	541, 553, 573	987040.....	561, 593, 595
984534.....	541, 553, 573	987060.....	559, 589
984535.....	541, 553, 573	987080.....	535, 537, 539, 541, 543, 547, 549, 551, 553, 583
984544.....	543, 557, 571, 573	988021.....	561
984545.....	543, 557, 571, 573	988025.....	619, 621
984554.....	533, 545	988028.....	619, 621
984555.....	533, 545	988054.....	627
984565.....	579	988055.....	627
984568.....	579	988084.....	623, 625
984570.....	585	988085.....	623, 625
984571.....	585	990109.....	627
984580.....	587		
984581.....	587		
984590.....	589		
984591.....	589		

**AT HOME EVERYWHERE – OUR LIGHTING SOLUTIONS
ARE AT HOME IN EVERY APPLICATION.
LET YOURSELF BE INSPIRED BY SELECTED PROJECT REFERENCES
FROM A WIDE VARIETY OF AREAS.**





With the kind support of Licht und Klein, Bergson-Gleichen

EXTERIOR

Whether free-standing luminaires, surface-mounted luminaires, underwater luminaires, recessed wall luminaires or wall washers - the outdoor area of a property, store or hotel should leave a lasting impression on visitors. Our example project shows a private house with an extensive outdoor area, which was staged with a great sense of noble elegance and lots of outdoor luminaires.

LIVING ROOM

Atmospheric lighting in the living room area is indispensable for creating a harmonious ambience. A prime example of the seamless integration of linear light into the building structure is shown in the project of a private residence. In order not to interrupt the area-wide effect of the 3D wallpaper along the open concrete staircase, the profiles and LED strips were integrated into the wall along the steps.





Foto: Daniel Vieser - Architektur fotografie, Karlsruhe

LINEAR LIGHT

In order to emphasize and highlight design elements in architecture or even to deliberately arouse emotions through the interplay of light and shadow, linear light is increasingly becoming the focus of attention. The office building of an architectural firm is impressive proof of this. A modern, open building – stylishly illuminated with linear lighting solutions from DEKO-LIGHT.



Foto: Daniel Vieser - Architektur fotografie, Karlsruhe

HOTEL AND GASTRONOMY

Bars, restaurants and hotels only become a cozy place where guests like to come again and again with the right lighting. For this reason, the versatile lighting and profile portfolio of DEKO-LIGHT was used for the lighting design of the extensive restaurant areas.





Mit freundlicher Unterstützung von SH-Lichttechnik / Beck's Reutlingen



STORE AND TRADE FAIR CONSTRUCTION

An individual and well thought-out lighting design not only enhances the visual value of a retail environment, but also has a sales-promoting effect. Flexibility is the key here, because the layout and displays of a store can change again and again. With our D LINE track systems and matching store fitting and display luminaires, you are ideally equipped to set the lighting stage for your sales areas.



OFFICE AND BUSINESS PREMISES

A pleasant atmosphere at work not only boosts the mood of employees, but also their motivation and productivity. For an ultra-modern new company building in Karlsruhe, only luminaires and lighting technology from DEKO-LIGHT are used in an area of over 16,000 m² – from recessed ceiling luminaires in the corridors to custom solutions in the foyer area.







COMMERCIAL

Commercial spaces are highly functional and place the highest demands on lighting efficiency. In our example project, the hall lighting for a BOSCH car service provider was implemented with TriProof LED surface-mounted ceiling luminaires, which with their IP65 protection class are convincing even in the adjacent car wash.

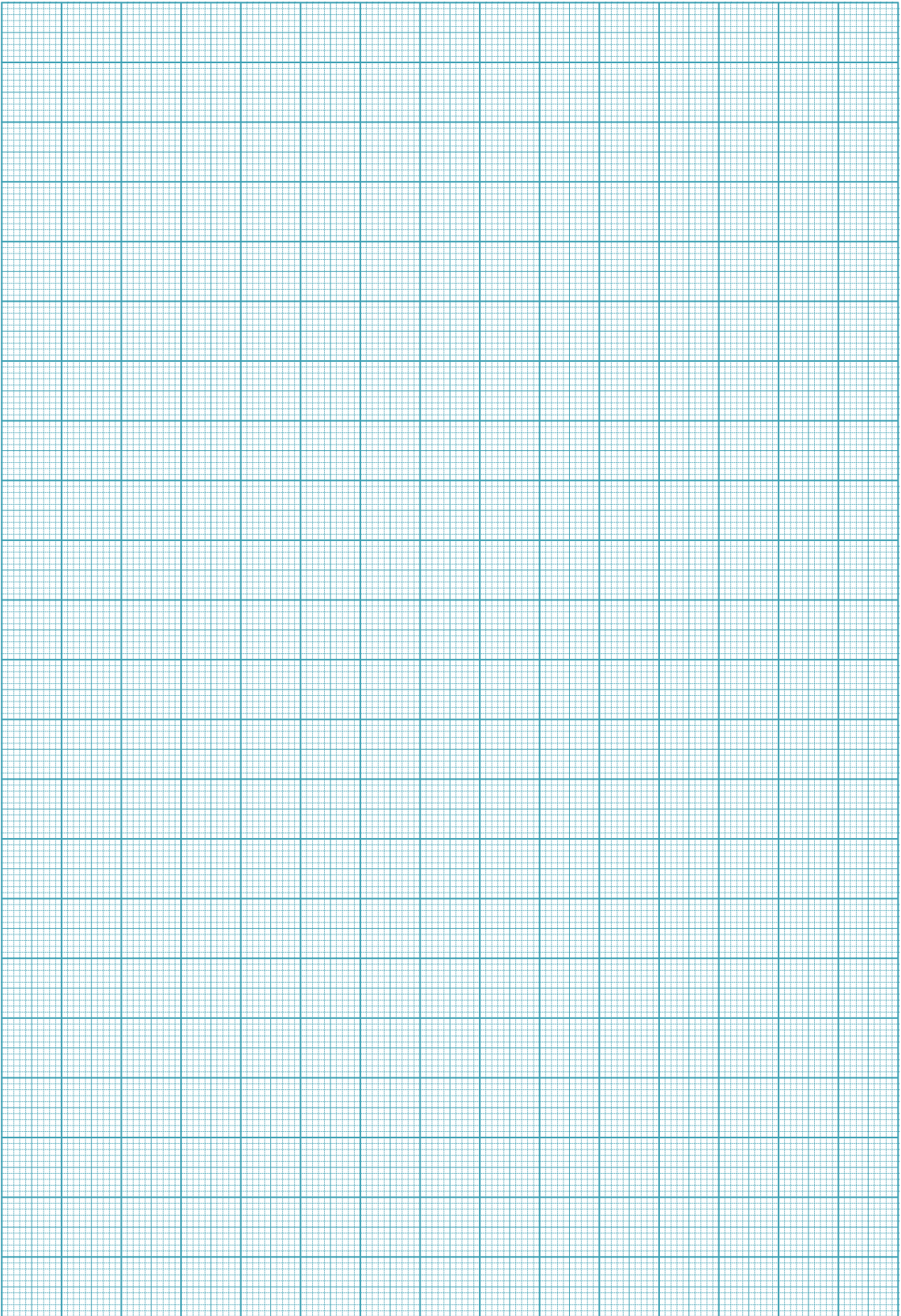

EVERYTHING ABOUT DEKO-LIGHT

In addition to the main catalogue, there are now also our application-specific segment catalogues or our SPOT ON! magazine, which provides plenty of inspiration as well as several products.



ALSO AVAILABLE ONLINE

Would you prefer to »leaf through« our publications online or on your tablet? You can find every catalogue, every brochure and all issues of the SPOT ON! Magazine on our homepage for browser viewing and as a PDF download.

DEKO-LIGHT
Elektronik Vertriebs GmbH
Auf der Hub 2
76307 Karlsbad

T +49 7248 9271 600
F +49 7248 9271 650

exporteu@deko-light.com
deko-light.com
shop.deko-light.com